



FRÖHLICH & DÖRKEN GmbH
BEWEGUNG, DIE BEGEISTERT

official
ZYS®
distributor

SPINDLE BEARINGS



THE POWER OF MOTION – FUD/ZYS SPINDLE BEARINGS.

FUD/ZYS spindle bearings are single-row angular ball bearings with restricted tolerances.

They support unilateral loads and have a standard contact angle of 15° or 25°.

The love for precision, the choice of raw material and the construction make the spindle bearing suitable for the highest of demands.

FUD/ZYS spindle bearings are optimized for highest rotational speed and running precision. In the process they show high stiffness and minimal heat and noise development.

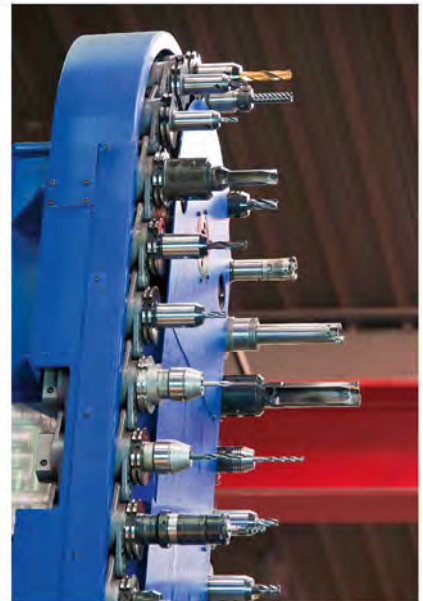

In order to install your spindle bearings in various applications, our spindle bearings will be delivered in standard universal designs.

Along with the standard models, we are also glad to offer you hybrid spindle bearings, enabling increased rotational speed which lowers maintenance costs.

Upon request we can deliver sealed or paired spindle bearings.



Contact our spindle bearing team and enjoy the benefits from FUD/ZYS:

- high delivery capacity
- high precision at unbeatable prices
- Calculation and construction for your use
- Conversion of previous product codes

OUR OFFER

We produce spindle bearings for you in the following series:

71800 to 71834
71900 to 71956
7000 to 7048
7200 to 7244

With contact angle from 15° to 25° (C or E)

Single or paired with sets of 2, 3 or 4 in X,O or tandem-arrangement in low, medium or high preload.

All bearings are producible as hybrid bearings according to your demands e.g. with ceramic balls or peek cage in accuracy classes P5, P4, P4A, P2.

Sealed spindle bearings are available by request.

Production as requested

in four months

Highest quality at

unbeatable prices

Calculation and designing for

your Application

Conversion of

your previous product codes

Try us! We keep our promises.

Well-known manufacturer for tools and quality machines trust our quality.

Contents

1 The types and characteristics of ZYS precision bearings	1
2 The principles of selecting precision bearings	7
3 The load rating and rating life	21
4 Preload and rigidity	24
5 Lubrication	41
6 Fitting	45
7 Matched bearing sets	51
8 Allowable operating temperature	52
9 Bearing mounting dimensions	53
10 Bearing mounting and adjustment	61
11 Machine tool bearings mounting examples	65
12 Bearing dimensions and technical parameters	72
13 Comparison table of bearing designations between ZYS and other manufacturers	153

1 The types and characteristics of ZYS precision bearings

1.1 Angular contact ball bearings

Single row angular contact ball bearings can not only withstand radial load and axial load in one direction, but also accommodate only axial load in single direction. And radial loads produce axial forces in these bearings that need to be balanced by counterforces. Therefore, the single row angular contact ball bearings often need to be mounted with other bearings which withstand axial load in the opposite direction. In other words, angular contact ball bearings are commonly used in pair, or in sets with three, four and even five bearings. Angular contact ball bearings have higher limited speed.

The ZYS precision angular contact ball bearings for spindles, have four size series, 718, 719, 70 and 72. With the same inner diameter, the outer diameters and the widths of 718, 719, 70 and 72 series increase in turn.

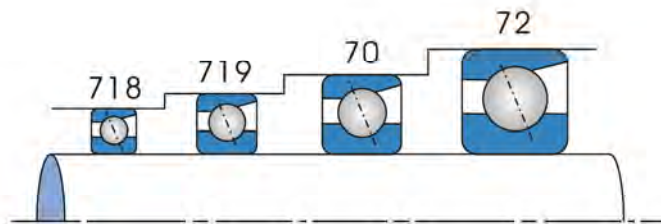

Fig.1 Angular contact ball bearings dimension series

ZYS precision angular contact ball bearings with 15° (C) and 25° (AC) contact angles. As for the angular contact ball bearings, the bigger the contact angle is, the greater the axial load capacity is, but the lower the limited speed of bearings becomes. Therefore, the spindle, with high speed and small axial load, should adopt the 15° angular contact ball bearings, whereas the 25° angular contact ball bearings should be adopted.

ZYS precision angular contact ball bearings with high-speed angular contact bearings (standard series), super-speed angular contact ball bearings, high-speed sealed angular contact ball bearings and high-speed spindle bearings.

The inner ring, outer ring and rolling element of rolling bearing under normal operating conditions are made of high carbon chromium bearing steel, but the steel bearings cannot meet the requirements of such special conditions as high speed, wear-resisting, low temperature rise, long life, high reliability, etc., then Si₃N₄ ceramics are believed to be present optimum rolling bearing materials to replace bearing steel.

Tab. 1 Main performance comparison between Si₃N₄ and bearing steel

Performance	Code and unit		Si ₃ N ₄	Bearing steel
Density	γ [g/mm ³]		3.2	7.8
Coefficient of thermal expansion	α [1/°C]	20~1000°C	3.2 × 10 ⁻⁶	-
		20~300°C	-	11.8 × 10 ⁻⁶
Modulus of elasticity	E [N/mm ²]		3.15 × 10 ⁵	2.08 × 10 ⁵
Poisson's ratio	μ		0.26	0.3
Rigidity	HV10		1700	700
Stress intensity	σ _B [N/mm ²]	20°C	700	2400
		1000°C	700	0
Fracture toughness	K _{Ic} [MN/m ^{1.5}]		7	25
Coefficient of heat conductivity	λ [W/m°C]		30~40	40~50
Electrical resistivity	[Ω mm ² /m]		10 ¹⁷ ~10 ¹⁸	0.1~1

ZYS also offers widely used hybrid angular contact ball bearings for spindles in high-speed precision machine tools and other high-speed precision machines, that is, the inner and outer rings are made of high-quality bearing steel materials, while the rolling elements are made of Si3N4 ceramics.

Compared to the angular contact ball bearings made of steel, hybrid angular contact ball bearings with the same structure and size have high speed, high rigidity, low friction heat, long life, etc.

ZYS precision hybrid bearings with ceramic balls (HQ1) can significantly improve the speed, rigidity, reliability and productivity of machine tools, and greatly reduce the friction heat, then extend the service life of host machine, etc.

Tab. 2 Types and performances of ZYS angular contact ball bearings

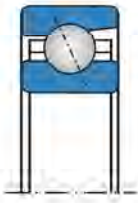
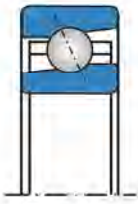
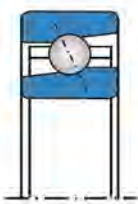
ZYS angular contact ball bearing series	Structures	Dimension series	Bore size range	Performance
High-speed angular contact ball bearings		718 C 718 AC 719 C 719 AC 70 C 70 AC 72 C 72 AC	718'' 10~360mm 719'' 8~460mm 70'' 8~380mm 72'' 8~220mm	.High speed .Large loading capacity .Suitable for grease or oil lubrication
Super-speed angular contact ball bearings(incl. hybrid ball bearings)		H719 C H719 AC H70 C H70 AC H719 C/HQ1 H719 AC/HQ H70 C/HQ1 H70 AC/HQ1	H719'' 8~220mm H70'' 8~220mm H719/HQ1'' 8~220mm H70/HQ1'' 8~220mm	.Super speed .High rigidity .Suitable for oil- air or oil jet lubrication
Super-speed angular contact ball bearings(incl. hybrid ball bearings)		H719 C H719 AC H70 C H70 AC H719 C/HQ1 H719 AC/HQ H70 C/HQ1 H70 AC/HQ1	H719'' 8~220mm H70'' 8~220mm H719/HQ1'' 8~220mm H70/HQ1'' 8~220mm	.Super speed .High rigidity .Suitable for oil- air or oil jet lubrication

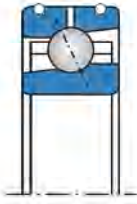
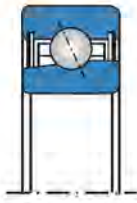
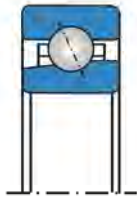
Super-speed angular contact ball bearings(incl. hybrid ball bearings)		H719 C-DL H719 AC-DL H70 C-DL H70 AC-DL H719 C-DL/HQ1 H719 AC-DL/HQ H70 C-DL/HQ1 H70 AC-DL/HQ1	H719-DL: 20~220mm H70-DL: 30~220mm H719-DL/HQ1: 20~220mm H70-DL/HQ1: 30~220mm	.Super speed .High rigidity .Suitable for direct lubrication
High-speed sealed angular contact ball bearings(incl. hybrid ball bearings)		B719 C-2RZ B719 AC-2RZ B70 C-2RZ B70 AC-2RZ B719 C-2RZ/HQ1 B719 AC-2RZ/HQ1 B70 C-2RZ/HQ1 B70 AC-2RZ/HQ1	B719-2RZ: 10~220mm B70-2RZ: 10~220mm B719-2RZ/HQ1: 10~220mm B70-2RZ/HQ1: 10~220mm	.High speed .High rigidity .Grease lubrication
High-speed spindle bearings (incl. hybrid ball bearings)		B70C B70C/HQ1	B70C: 10~60mm B70C/HQ1: 10~60mm	.Super speed .High rigidity .Suitable for oil mist lubrication

1.2 Cylindrical roller bearings

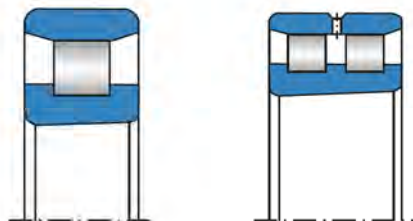

Fig. 2 ZYS cylindrical roller bearings

Cylindrical roller bearings belong to line contact, with higher capacity and rigidity than angular contact ball bearings (including multiple sets of bearings). But the allowable speed is lower. Therefore, cylindrical roller bearings are used in the medium, large-scale machine tool with large load, high rigidity and low speed.

ZYS cylindrical roller bearings including two structure series: single row bearings N10 and double row bearings NN30.

Single row cylindrical roller bearings, as free supports, are usually matched with angular contact ball bearings which serve as fixed supports.

The most commonly used cylindrical roller bearings in the machine tool are double row cylindrical roller bearings with tapered bore. This kind of bearings can bear greater radial load with detachable inner and outer rings, and can not bear the axial load. So they are often used with double-direction angular contact thrust ball bearings which bear axial load.

Double row cylindrical roller bearings with tapered bore (taper 1:12, that is, semi-coning is $2^{\circ} 23'9.4''$) are matched with tapered shaft neck of spindles. During the process of bearing assembly, the axial movement of inner ring can swell the inner ring, and then the internal radial clearance can be changed and the bearing preload will be achieved.

As for the N10 and NN30 series of cylindrical roller bearings, the inner ring has shoulder, the outer ring can be separated. For double row cylindrical roller bearings used with oil lubrication, a circumferential oil groove and three symmetric lubricant holes are set in the middle of outer ring, marked W33.

1.3 Double-direction angular contact thrust ball bearings

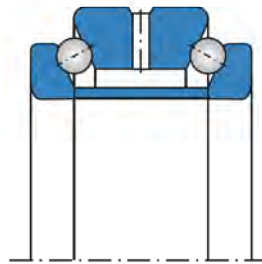

Fig. 3 ZYS Double-direction angular contact thrust ball bearings

Double-direction angular contact thrust ball bearing is composed of two shaft washers, a housing washer, a spacer, two rolling elements and cage components. Grinding the thickness of spacer can adjust the clearance and preloaded of bearing. The contact angle is 60° . This kind of bearing and its matched double row cylindrical roller bearings are the same of nominal outside diameter, but there is gap between the outer ring and housing, thus, the double-direction angular contact thrust ball bearing does not support radial load but double direction axial load.

Double-direction angular contact thrust ball bearings with two dimension series, 2344 and 2347. 2344 series are fit for the small end of taper bore of double row cylindrical roller bearings, and 2347 series for the large end.

As for ZYS double-direction angular contact thrust ball bearings, a circumferential oil groove and three symmetric lubrication holes are set up in the middle of outer ring. Lubricants are led into the space between the double row rolling elements and cage assemblies, then lubrication through the rotation of bearing will be realized.

ZYS double-direction angular contact thrust ball bearings have such advantages as high accuracy, high rigidity, low temperature rise, high speed and convenient fixing and removing.

1.4 High-speed angular contact thrust ball bearings

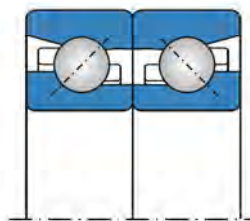

Fig. 4 High-speed angular contact thrust ball bearing structure

As the substitutes of double-direction angular contact thrust ball bearings, high-speed angular contact thrust ball bearings are composed of two sets of angular contact ball bearings with 30° or 40° contact angle and back-to-back arrangement. These bearings and double-direction angular contact thrust ball bearings have the same outside diameter tolerance of outer ring, then there is clearance between outside diameter and the hole of bearing housing, therefore, high-speed angular contact thrust ball bearings do not bear radial load.

High-speed angular contact thrust ball bearings not only maintain high rigidity, but also achieve high speed and low temperature rise.

The code of ZYS high-speed angular contact thrust ball bearings is $70 \times 2 A/DB$ (30° contact angle) and $70 \times 2 B/DB$ (40° contact angle).

In order to achieve interchange between high-speed angular contact thrust ball bearings and double-direction angular contact thrust ball bearings, high-speed angular contact thrust ball bearings are adopted with a special width dimension, which is shown in Fig. 5, $2B = A$. When the high-speed angular contact thrust ball bearings substitute double-direction angular contact thrust ball bearings, the structure and dimensions of shaft and bearing do not need changing, while the washer 2 should be substituted for the washer 1.



Fig. 5 The mounting of high-speed angular contact thrust ball bearings

1.5 Tapered roller bearings

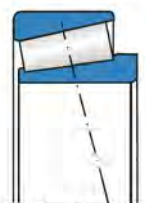

Fig. 6 Tapered roller bearings

Single row tapered roller bearings can support radial load and axial load in one direction. The radial load makes bearing generate an axial component force, therefore, this bearing is often used with another tapered roller bearings in conjunction. Tapered roller bearing can bear large axial load, but its speed performance is low. In addition, thanks to the separable inner and outer ring, mounting and dismounting tapered roller bearings are very convenient.

The most commonly used tapered roller bearings in machine spindles are 32000 dimension series.

1.6 Ball screw support bearings

ZYS precision ball screw support bearing is one kind of one-direction angular contact thrust ball bearing (60° contact angle) with high accuracy, high speed, high axial rigidity, low friction, long life and transient high/low speed conversion. The bearing is particularly suitable for the ball screw support and other similar transmission components in high-speed precision CNC machine tools.

ZYS precision ball screw support bearings including four series: 7602, 7603, BS, BSS. The standard metric 7602 and 7603 series correspond to JB/T8564 (Chinese Mechanical Standard), with the bore diameter from 12mm to 130mm; BS series are non-standard metric and BSS series are inch series.

Ball screw support bearings can support larger axial load in one direction and a certain radial load. These bearings are usually arranged in duplex or multiple sets with the same arranging modes as the way of angular contact ball bearings.

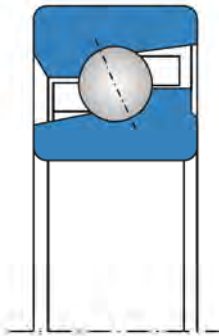

Fig. 7 Ball screw support bearings

1.7 Sealed ball screw support bearings

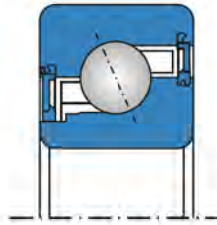

Fig. 8 Sealed ball screw support bearings

In order to meet the developing trend of smaller machine tool with more compact structure, ZYS developed sealed ball screw support bearings. The seals at both ends of bearing can prevent cutting fluid and metal scrap into the bearing.

1.8 Ball screw support bearing units

ZYS ball screw support bearing units refer to combining matched bearings and relevant accessories together into ball screw support components, with simple mounting, convenient use, reliable operation and such features.

According to the different bearings arranging modes, ZYS ball screw support bearing units have three types: BSDU……DF, BSTU……TFT and BSQU……QFC.

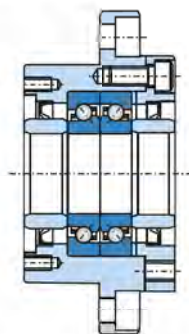

Fig. 9 Ball screw support bearing units

1.9 Rotary table bearings

ZYS rotary table bearings are axial/radial cylindrical roller bearings, are composed of two thrust roller bearings and a radial cylindrical roller bearing with the combination of axial and radial preload. For the convenience of transportation and mounting, use two or three symmetrical fixing screws to fasten the two shaft washers in order to prevent collision between rolling elements and rings, and avoid bad influence on bearing accuracy.

This kind of bearing can support great radial and axial pressure and overturning moment with high rigidity, so it is especially used for large rotary table and large turntable.

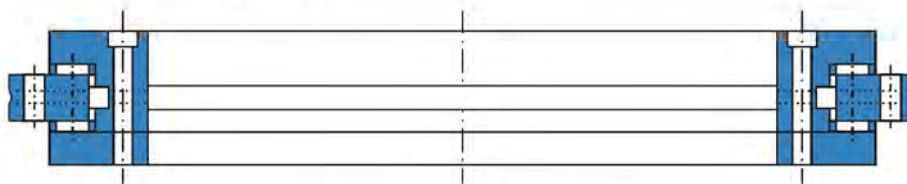

Fig. 10 Axial/radial bearings YRT

1.10 Turbocharger bearings

The turbocharger bearings that ZYS developed refer to deep groove ball bearings, cylindrical roller bearings, angular contact ball bearings and four-point contact ball bearings. Angular contact ball bearings are used in pairs or matched with four-point contact ball bearings.

Deep groove ball bearings and cylindrical roller bearings mainly support radial load, the angular contact ball bearings used in pair and angular contact ball bearings matched with four-point contact ball bearings can support radial and axial combined loads. ZYS turbocharger bearings have such features as high limiting speed, large carrying capacity and long service life.

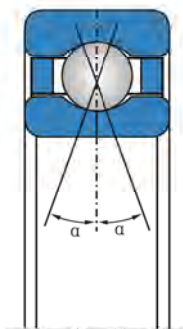

Fig. 11 Four-point contact ball bearings for turbo charger

For the turbocharger bearings with higher speed and greater load, its cage material is alloy steel with special treatment on its surface.

1.11 Precision locknuts

ZYS precision locknuts can guarantee the precise positioning of bearings and other mechanical parts in the axis. The nut has a simple structure, convenient usage, accurate positioning, high reliability, etc.

2.The principles of selecting precision bearings

ZYS has developed and produced various types and structures of high-speed precision bearings, each of which has special working conditions. Selecting different types and structures should depend on specific working conditions. When choosing bearings, the following properties should be taken into consideration.

2.1 Dimension series

Among ZYS precision bearings, angular contact ball bearings have four diameter series 18, 19, (1) 0, (0) 2; the ball screw support bearings have two diameter series, (0) 2, (0) 3. With the the same bore diameter, the outer diameters and width dimensions of 18, 19, (1) 0, (0) 2, (0) 3 series increase in turn.

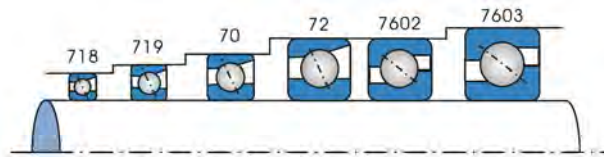

Fig. 12 The comparison of each dimension series between angular contact ball bearings and ball screw support bearings

The (1) 0 diameter series bearings are most usually used among angular contact ball bearings, cylindrical roller bearings, double-direction angular contact thrust ball bearings and tapered roller bearings for high-speed precision machine spindle.

As for the angular contact ball bearings, if the radial space in mounting position is limited or the required speed of spindle is higher, (1) 0 or 19 diameter series are recommended, and even 18 diameter series; if spindle supports large load, speed is not quite high and mounting space is not limited, the (0) 2 diameter series are preferred.

The greater the axis diameter of spindle is, the higher the rigidity becomes. To improve the bearing rigidity is to increase the number of balls, which is more favorable than increasing the ball diameter.

2.2 Bearing accuracy

2.2.1 Running accuracy

Running accuracy of bearings directly determines the rotation and the machining accuracy of machine tools. The radial runout of inner ring is particularly important. The accuracy of spindle and housing must be matched with the accuracy of their matching bearings.

Among ZYS high-speed precision bearings, the standard accuracy class of angular contact ball bearings and ball screw support bearings is ISO Class 4 (equivalent to American Bearing Manufacturers Association ABEC Class 7); for cylindrical roller bearings and double-direction angular contact thrust ball bearings, the standard accuracy class is SP. If more precise bearings are needed, we can provide angular contact ball bearings and ball screw support bearings on Class P4A (dimensional accuracy is equivalent to ISO Class 4, running accuracy is higher than the ISO Class 4), ultra-precision bearings on ISO Class 2 (equivalent to ABEC Class 9) and double row cylindrical roller bearings and double-direction angular contact thrust ball bearings on Class UP, the higher accuracy class.

2.2.2 Dimensional accuracy

For the high-precision bearings, 18, 19, (1)0 dimensional series in particular, the ring thickness is thin, so the fitting condition, when the bearing is assembled to spindle and housing, has a significant impact on the running accuracy, internal clearance or preload of the bearing. Therefore, not only the bearing should have a higher dimensional accuracy, but its matching spindle diameter and housing bore should also have the corresponding high dimensional accuracy and surface quality.

Tab. 3 Symbols of bearing outside dimensions and running accuracy

Symbols	Meanings
d	Nominal bore diameter
Δd_s	Deviation of a single bore diameter
Δd_{mp}	Deviation of mean bore diameter (the nominal small end of taper bore)
Δd_{1mp}	Deviation of diameter of the theoretical basic tapered bore big end
V_{dsp}	Variation of bore diameter in one radial plane
V_{dmp}	Variation of mean bore diameters (only for cylindrical bore)

D	Nominal outside diameter
ΔD_s	Deviation of a single outside diameter
ΔD_{mp}	Deviation of mean outside diameter in a single plane
V_{Dsp}	Variation of outside diameter in a single plane
V_{Dmp}	Variation of mean outside diameter
ΔB_s	Deviation of a single inner ring width
V_{BS}	Variation of inner ring width
ΔC_s	Deviation of a single outer ring width from nominal dimension
V_{CS}	Variation of outer ring width
K_{ia}	Radial runout of inner ring of assembled bearing
K_{ea}	Radial runout of outer ring of assembled bearing
S_{ia}	Axial runout of inner ring of assembled bearing to inner ring raceway
S_{ea}	Axial runout of outer ring of assembled bearing to outer ring raceway
S_d	Side face runout of inner ring with reference to bore
S_D	Variation in inclination of outside cylindrical surface to outer ring side face
S_i	Variation in thickness between raceway and end of double-direction angular contact thrust ball bearing shaft washers
S_e	Variation in thickness between raceway and end of double-direction angular contact thrust ball bearing housing washers
ΔT_s	Deviation of a single height of double-direction angular contact thrust ball bearings
ΔC_s	Deviation of a single width of the housing washer of double-direction angular contact thrust ball bearings

Tab. 4 Tolerances for the inner ring of angular contact ball bearings in P5

μm

d mm		Δd_{mp}		$V_{dsp}^{(1)}$		V_{dmp}	K_{ia}	S_d	S_{ia}	ΔB_s			V_{BS}
				Diameter series						All	Normal	Revise	
From	to	Upper deviation	Lower deviation	9	0、2	max			Upper deviation				Lower deviation
2.5	10	0	-5	5	4	3	4	7	7	0	-40	-250	5
10	18	0	-5	5	4	3	4	7	7	0	-80	-250	5
18	30	0	-6	6	5	3	4	8	8	0	-120	-250	5
30	50	0	-8	8	6	4	5	8	8	0	-120	-250	5
50	80	0	-9	9	7	5	5	8	8	0	-150	-250	6
80	120	0	-10	10	8	5	6	9	9	0	-200	-380	7
120	180	0	-13	13	10	7	8	10	10	0	-250	-380	8
180	250	0	-15	15	12	8	10	11	13	0	-300	-500	10

Notes:

(1) No special values for diameter series 8.

(2) For the inner ring width deviation of a single bearing when matched in pair or group.

Tab. 5 Tolerances for the outer ring of angular contact ball bearings in P5

 μm

D mm		ΔD_{mp}		V _{Dsp} ⁽¹⁾⁽²⁾		V _{Dmp}	K _{ea}	S _D	S _{ea}	ΔC_s		V _{Cs}
				Diameter series								
				9	0, 2							
From	to	Upper deviation	Lower deviation	max						Upper deviation	Lower deviation	max
6	18	0	-5	5	4	3	5	8	8			5
18	30	0	-6	6	5	3	6	8	8			5
30	50	0	-7	7	5	4	7	8	8			5
50	80	0	-9	9	7	5	8	8	10	Width deviation ΔC_s is identical with ΔB_s of the corresponding inner ring.		6
80	120	0	-10	10	8	5	10	9	11			8
120	150	0	-11	11	8	6	11	10	13			8
150	180	0	-13	13	10	7	13	10	14			8
180	250	0	-15	15	11	8	15	11	15			10
250	315	0	-18	18	14	9	18	13	18		11	
315	400	0	-20	20	15	10	20	13	20		13	

Notes:

- (1) No special values for diameter series 8.
 (2) No special values for sealed bearings.

Tab. 6 Tolerances for the inner ring of angular contact ball bearings in P4

 μm

d mm		Δd_{mp}		$\Delta d_s^{(1)}$		V _{Dsp} ⁽²⁾		V _{dmp}	K _{ia}	S _d	S _{ia}	ΔB_s			V _{Bs}
						Diameter series						All	Normal	Revise	
						9	0, 2								
From	to	Upper deviation	Lower deviation	Upper deviation	Lower deviation	max						Upper deviation	Lower deviation	max	
2.5	10	0	-4	0	-4	4	3	2	2.5	3	3	0	-40	-250	2.5
10	18	0	-4	0	-4	4	3	2	2.5	3	3	0	-80	-250	2.5
18	30	0	-5	0	-5	5	4	2.5	3	4	4	0	-120	-250	2.5
30	50	0	-6	0	-6	6	5	3	4	4	4	0	-120	-250	3
50	80	0	-7	0	-7	7	5	3.5	4	5	5	0	-150	-250	4
80	120	0	-8	0	-8	8	6	4	5	5	5	0	-200	-380	4
120	180	0	-10	0	-10	10	8	5	6	6	7	0	-250	-380	5
180	250	0	-12	0	-12	12	9	6	8	7	8	0	-300	-500	6

Notes:

- (1) Only applied to diameter series 0, 1, 2, 3, 4.
 (2) No special values for diameter series 8.
 (3) For the inner ring width deviation of a single bearing when matched in pair or group.

Tab. 7 Tolerances for the outer ring of angular contact ball bearings in P4

μ m

D mm		ΔD _{mp}		ΔD _s ⁽¹⁾⁽²⁾⁽³⁾		VD _{dsp} ⁽²⁾⁽³⁾		VD _{mp}	K _{ea}	S _D	S _{ea}	ΔC _s		V _{cs}
						Diameter series						Upper deviation	Lower deviation	
						9	0, 2							
From	to	Upper deviation	Lower deviation	Upper deviation	Lower deviation	max					Upper deviation	Lower deviation	max	
6	18	0	-4	0	-4	4	3	2	3	4	5			2.5
18	30	0	-5	0	-5	5	4	2.5	4	4	5			2.5
30	50	0	-6	0	-6	6	5	3	5	4	5			2.5
50	80	0	-7	0	-7	7	5	3.5	5	4	5	Width deviation ΔC _s is identical with ΔB _s of the corresponding inner ring.		3
80	120	0	-8	0	-8	8	6	4	6	5	6			4
120	150	0	-9	0	-9	9	7	5	7	5	7			5
150	180	0	-10	0	-10	10	8	5	8	5	8			5
180	250	0	-11	0	-11	11	8	6	10	7	10			7
250	315	0	-13	0	-13	13	10	7	11	8	10		7	
315	400	0	-15	0	-15	15	11	8	13	10	13		8	

Notes:

- (1) Only applied to diameter series 0, 1, 2, 3, 4.
- (2) No special values for diameter series 8.
- (3) No special values for sealed bearings.

Tab. 8 Tolerances for the inner ring of angular contact ball bearings in P4A

μ m

d mm		Δd _{mp}		Δd _s ⁽¹⁾		V _{dsp} ⁽²⁾	V _{dmp}	K _{ia}	S _d	S _{ia}	ΔB _s			V _{BS}
											All	Normal	Revise	
											Upper deviation	Lower deviation		
From	to	Upper deviation	Lower deviation	Upper deviation	Lower deviation	max					Upper deviation	Lower deviation	max	
2.5	10	0	-4	0	-4	2.5	1.5	1.5	1.5	1.5	0	-40	-250	1.5
10	18	0	-4	0	-4	2.5	1.5	1.5	1.5	1.5	0	-80	-250	1.5
18	30	0	-5	0	-5	2.5	1.5	2.5	1.5	2.5	0	-120	-250	1.5
30	50	0	-6	0	-6	2.5	1.5	2.5	1.5	2.5	0	-120	-250	1.5
50	80	0	-7	0	-7	4	2	2.5	1.5	2.5	0	-150	-250	1.5
80	120	0	-8	0	-8	5	2.5	2.5	2.5	2.5	0	-200	-380	2.5
120	150	0	-10	0	-10	7	3.5	2.5	2.5	2.5	0	-250	-380	2.5
150	180	0	-10	0	-10	7	3.5	5	4	5	0	-250	-380	4
180	250	0	-12	0	-12	8	4	5	5	5	0	-300	-500	5

Notes:

- (1) Only applied to diameter series 0, 1, 2, 3, 4.
- (2) No special values for diameter series 8 and 9.
- (3) For the inner ring width deviation of a single bearing when matched in pair or group.

Tab. 9 Tolerances for the outer ring of angular contact ball bearings in P4A

 μm

D mm		ΔD_{mp}		$\Delta D_s^{(1)(2)(3)}$		V_{dsp}	V_{dmp}	K_{ea}	S_D	S_{ea}	ΔC_s		V_{cs}
From	to	Upper deviation	Lower deviation	Upper deviation	Lower deviation	max					Upper deviation	Lower deviation	max
6	18	0	-4	0	-4	2.5	1.5	1.5	1.5	1.5			1.5
18	30	0	-5	0	-5	4	2	2.5	1.5	2.5			1.5
30	50	0	-6	0	-6	4	2	2.5	1.5	2.5			1.5
50	80	0	-7	0	-7	4	2	4	1.5	4			1.5
80	120	0	-8	0	-8	5	2.5	5	2.5	5	Width deviation ΔC_s is identical with ΔB_s of the corresponding inner ring.		2.5
120	150	0	-9	0	-9	5	2.5	5	2.5	5			2.5
150	180	0	-10	0	-10	7	3.5	5	2.5	5			2.5
180	250	0	-11	0	-11	8	4	7	4	7			4
250	315	0	-13	0	-13	8	4	7	5	7			5
315	400	0	-15	0	-15	10	5	8	7	8			7

Notes:

- (1) Only applied to diameter series 0, 1, 2, 3, 4.
- (2) No special values for diameter series 8.
- (3) No special values for sealed bearings.

Tab. 10 Tolerances for the inner ring of angular contact ball bearings in P2

 μm

d mm		Δd_{mp}		Δd_s		$V_{dsp}^{(1)}$	V_{dmp}	K_{ia}	S_d	S_{ia}	ΔB_s			V_{BS}
From	to	Upper deviation	Lower deviation	Upper deviation	Lower deviation	max					All	Normal	Revise	max
											Upper deviation	Lower deviation		
2.5	10	0	-2.5	0	-2.5	2.5	1.5	1.5	1.5	1.5	0	-40	-250	1.5
10	18	0	-2.5	0	-2.5	2.5	1.5	1.5	1.5	1.5	0	-80	-250	1.5
18	30	0	-2.5	0	-2.5	2.5	1.5	2.5	1.5	2.5	0	-120	-250	1.5
30	50	0	-2.5	0	-2.5	2.5	1.5	2.5	1.5	2.5	0	-120	-250	1.5
50	80	0	-4	0	-4	4	2	2.5	1.5	2.5	0	-150	-250	1.5
80	120	0	-5	0	-5	5	2.5	2.5	2.5	2.5	0	-200	-380	2.5
120	150	0	-7	0	-7	7	3.5	2.5	2.5	2.5	0	-250	-380	2.5
150	180	0	-7	0	-7	7	3.5	5	4	5	0	-250	-380	4
180	250	0	-8	0	-8	8	4	5	5	5	0	-300	-500	5

Notes:

- (1) No special values for diameter series 8 and 9.
- (2) For the inner ring width deviation of a single bearing when matched in pair or group.

Tab. 11 Tolerances for the outer ring of angular contact ball bearings in P2

μ m

D mm		ΔD _{mp}		ΔD _s		V _{Dsp}	V _{Dmp}	K _{ea}	S _D	S _{ea}	ΔC _s		V _{cs}
From	to	Upper deviation	Lower deviation	Upper deviation	Lower deviation	max					Upper deviation	Lower deviation	max
6	18	0	-2.5	0	-2.5	2.5	1.5	1.5	1.5	1.5			1.5
18	30	0	-4	0	-4	4	2	2.5	1.5	2.5			1.5
30	50	0	-4	0	-4	4	2	2.5	1.5	2.5			1.5
50	80	0	-4	0	-4	4	2	4	1.5	4			1.5
80	120	0	-5	0	-5	5	2.5	5	2.5	5	Width deviation ΔC _s is identical with ΔB _s of the corresponding inner ring.		2.5
120	150	0	-5	0	-5	5	2.5	5	2.5	5			2.5
150	180	0	-7	0	-7	7	3.5	5	2.5	5			2.5
180	250	0	-8	0	-8	8	4	7	4	7			4
250	315	0	-8	0	-8	8	4	7	5	7			5
315	400	0	-10	0	-10	10	5	8	7	8			7

Tab. 12 Tolerances for the inner ring (straight bore) of single row cylindrical roller bearings in SP

μ m

d mm		Δd _{mp}		Δd _s		V _{dsp}	K _{ia}	S _d	V _{BS}	ΔB _s	
From	to	Upper deviation	Lower deviation	Upper deviation	Lower deviation	max				Upper deviation	Lower deviation
18	30	0	-6	0	-6	3	3	3	1.5	0	-120
30	50	0	-8	0	-8	4	4	3	2	0	-120
50	80	0	-9	0	-9	5	4	4	3	0	-150
80	120	0	-10	0	-10	5	5	4	3	0	-200
120	180	0	-13	0	-13	7	6	5	4	0	-250
180	250	0	-15	0	-15	8	8	6	5	0	-300
250	315	0	-18	0	-18	9	10	6	5	0	-350

Tab. 13 Tolerances for the outer ring of single row cylindrical roller bearings in SP μm

D mm		ΔD_{mp}		ΔD_s		V_{Dsp}	K_{ea}	S_D
From	to	Upper deviation	Lower deviation	Upper deviation	Lower deviation	max		
30	50	0	-7	0	-7	4	5	8
50	80	0	-9	0	-9	5	5	8
80	120	0	-10	0	-10	5	6	9
120	150	0	-11	0	-11	6	7	10
150	180	0	-13	0	-13	7	8	10
180	250	0	-15	0	-15	8	10	11
250	315	0	-18	0	-18	9	11	13
315	400	0	-20	0	-20	10	13	13

Notes: The V_{cs} 、 ΔC_s of outer ring is identical with V_{Bs} 、 ΔB_s of the corresponding inner ring.

 Tab. 14 Tolerances for the inner ring (straight bore) of single row cylindrical roller bearings in UP μm

d mm		Δd_{mp}		Δd_s		V_{dsp}	K_{ia}	S_d	V_{BS}	ΔB_s	
From	to	Upper deviation	Lower deviation	Upper deviation	Lower deviation	max				Upper deviation	Lower deviation
18	30	0	-5	0	-5	2.5	1.5	3	1.5	0	-25
30	50	0	-6	0	-6	3	2	3	2	0	-30
50	80	0	-7	0	-7	3.5	2	4	3	0	-40
80	120	0	-8	0	-8	4	3	4	3	0	-50
120	180	0	-10	0	-10	5	3	5	4	0	-60
180	250	0	-12	0	-12	6	4	6	5	0	-75
250	315	0	-15	0	-15	8	4	6	5	0	-100

 Tab. 15 Tolerances for the outer ring of single row cylindrical roller bearings in UP μm

D mm		ΔD_{mp}		ΔD_s		V_{Dsp}	K_{ea}	S_D
From	to	Upper deviation	Lower deviation	Upper deviation	Lower deviation	max		
30	50	0	-5	0	-5	3	3	2
50	80	0	-6	0	-6	3	3	2
80	120	0	-7	0	-7	4	3	3
120	150	0	-8	0	-8	4	4	3
150	180	0	-9	0	-9	5	4	3
180	250	0	-10	0	-10	5	5	4
250	315	0	-12	0	-12	6	6	4
315	400	0	-14	0	-14	7	7	5

Notes: The V_{cs} 、 ΔC_s of outer ring is identical with V_{Bs} 、 ΔB_s of the corresponding inner ring.

Tab. 16 Tolerances for the tapered bore of single row cylindrical roller bearings μm

d mm		SP tolerances					UP tolerances				
		Δd_{mp}		$\Delta d_{1mp} - \Delta d_{mp}$		V_{dsp} max	Δd_{mp}		$\Delta d_{1mp} - \Delta d_{mp}$		V_{dsp} max
From	to	Upper deviation	Lower deviation	Upper deviation	Lower deviation		Upper deviation	Lower deviation	Upper deviation	Lower deviation	
18	30	+10	0	+4	0	3	+6	0	+2	0	2.5
30	50	+12	0	+6	0	4	+7	0	+3	0	3
50	80	+15	0	+6	0	5	+8	0	+3	0	3.5
80	120	+20	0	+8	0	5	+10	0	+4	0	4
120	180	+25	0	+8	0	7	+12	0	+4	0	5
180	250	+30	0	+10	0	8	+14	0	+5	0	6
250	315	+35	0	+12	0	9	+15	0	+6	0	8

Tab. 17 Tolerances for the inner ring (straight bore) of double row cylindrical roller bearings in SP μm

d mm		Δd_{mp}		Δd_s		V_{dsp}	K_{Ia}	S_d	V_{BS}	ΔB_s	
From	to	Upper deviation	Lower deviation	Upper deviation	Lower deviation					max	
18	30	0	-6	0	-6	3	3	8	5	0	-120
30	50	0	-8	0	-8	4	4	8	5	0	-120
50	80	0	-9	0	-9	5	4	8	6	0	-150
80	120	0	-10	0	-10	5	5	9	7	0	-200
120	180	0	-13	0	-13	7	6	10	8	0	-250
180	250	0	-15	0	-15	8	8	11	10	0	-300
250	315	0	-18	0	-18	9	8	13	13	0	-350

Tab. 18 Tolerances for the outer ring of double row cylindrical roller bearings in SP μm

D mm		ΔD_{mp}		ΔD_s		V_{Dsp}	K_{Ea}	S_D
From	to	Upper deviation	Lower deviation	Upper deviation	Lower deviation			
30	50	0	-7	0	-7	4	5	8
50	80	0	-9	0	-9	5	5	8
80	120	0	-10	0	-10	5	6	9
120	150	0	-11	0	-11	6	7	10
150	180	0	-13	0	-13	7	8	10
180	250	0	-15	0	-15	8	10	11
250	315	0	-18	0	-18	9	11	13
315	400	0	-20	0	-20	10	13	13

Notes: The V_{Cs} , ΔCs of outer ring is identical with V_{Bs} , ΔBs of the corresponding inner ring.

Tab. 19 Tolerances for the inner ring (straight bore) of double row cylindrical roller bearings in UP
 μm

d mm		Δd_{mp}		Δd_s		V_{dsp}	K_{ia}	S_d	V_{Bs}	ΔB_s	
From	to	Upper deviation	Lower deviation	Upper deviation	Lower deviation	max				Upper deviation	Lower deviation
18	30	0	-5	0	-5	2.5	1.5	3	1.5	0	-25
30	50	0	-6	0	-6	3	2	3	2	0	-30
50	80	0	-7	0	-7	3.5	2	4	3	0	-40
80	120	0	-8	0	-8	4	3	4	3	0	-50
120	180	0	-10	0	-10	5	3	5	4	0	-60
180	250	0	-12	0	-12	6	4	6	5	0	-75
250	315	0	-15	0	-15	8	4	6	5	0	-100

 Tab. 20 Tolerances for the outer ring of double row cylindrical roller bearings in UP
 μm

D mm		ΔD_{mp}		ΔD_s		V_{Dsp}	K_{ea}	S_D
From	to	Upper deviation	Lower deviation	Upper deviation	Lower deviation	max		
30	50	0	-5	0	-5	3	3	2
50	80	0	-6	0	-6	3	3	2
80	120	0	-7	0	-7	4	3	3
120	150	0	-8	0	-8	4	4	3
150	180	0	-9	0	-9	5	4	3
180	250	0	-10	0	-10	5	5	4
250	315	0	-12	0	-12	6	6	4
315	400	0	-14	0	-14	7	7	5

Notes: The V_{cs} , ΔC_s of outer ring is identical with V_{Bs} , ΔB_s of the corresponding inner ring.

Tab. 21 Tolerances for tapered bore of double row cylindrical roller bearings

 μm

d mm		SP tolerances					UP tolerances				
From	to	Δd_{mp}		$\Delta d_{imp} - \Delta d_{mp}$		V_{dsp} max	Δd_{mp}		$\Delta d_{imp} - \Delta d_{mp}$		V_{dsp} max
		Upper deviation	Lower deviation	Upper deviation	Lower deviation		Upper deviation	Lower deviation	Upper deviation	Lower deviation	
18	30	+10	0	+4	0	3	+6	0	+2	0	2.5
30	50	+12	0	+6	0	4	+7	0	+3	0	3
50	80	+15	0	+6	0	5	+8	0	+3	0	3.5
80	120	+20	0	+8	0	5	+10	0	+4	0	4
120	180	+25	0	+8	0	7	+12	0	+4	0	5
180	250	+30	0	+10	0	8	+14	0	+5	0	6
250	315	+35	0	+12	0	9	+15	0	+6	0	8
315	400	+40	0	+12	0	12	+17	0	+6	0	10

Tab. 22 Tolerances for shaft washer of double-direction angular contact thrust ball bearings in SP, UP

μ m

d mm		SP Tolerances					UP Tolerances			SP, UP Tolerances	
		Δd _{mp}		Δd _s		S _i , S _e max	Δd _{mp} , Δd _s		S _i , S _e max	ΔT _s	
From	to	Upper deviation	Lower deviation	Upper deviation	Lower deviation		Upper deviation	Lower deviation		Upper deviation	Lower deviation
—	30	0	-8	+1	-9	3	0	-6	1.5	+50	-80
30	50	0	-10	+1	-11	3	0	-8	1.5	+60	-100
50	80	0	-12	+2	-14	4	0	-9	2	+70	-120
80	120	0	-15	+3	-18	4	0	-10	2	+85	-140
120	180	0	-18	+3	-21	5	0	-13	3	+95	-160
180	250	0	-22	+4	-26	5	0	-15	3	+120	-200
250	315	0	-25	+5	-30	7	0	-18	4	+150	-250

Tab. 23 Tolerances for housing washer of double-direction angular contact thrust ball bearings in SP, UP

μ m

D mm		ΔD _{mp}		ΔC _s	
From	to	Upper deviation	Lower deviation	Upper deviation	Lower deviation
30	50	-20	-27	0	-30
50	80	-24	-33	0	-30
80	120	-28	-38	0	-30
120	150	-33	-44	0	-30
150	180	-33	-46	0	-30
180	250	-37	-52	0	-30
250	315	-41	-59	0	-30
315	400	-46	-64	0	-30

Tab. 24 Tolerances for inner ring of tapered roller bearings in P5

μ m

d mm		Δd _{mp}		V _{dsp}	V _{dmp}	K _{ia}	S _d	ΔB _s		ΔT _s	
From	to	Upper deviation	Lower deviation	max			Upper deviation	Lower deviation	Upper deviation	Lower deviation	
18	30	0	-8	6	5	5	8	0	-200	+200	-200
30	50	0	-10	8	5	6	8	0	-240	+200	-200
50	80	0	-12	9	6	7	8	0	-300	+200	-200
80	120	0	-15	11	8	8	9	0	-400	+200	-200
120	180	0	-18	14	9	11	10	0	-500	+350	-250
180	250	0	-22	17	11	13	11	0	-600	+350	-250

Tab. 25 Tolerances for outer ring of tapered roller bearings in P5

μ m

D mm		ΔD _{mp}		V _{Dsp}	V _{Dmp}	S _D	ΔC _s	
From	to	Upper deviation	Lower deviation	max			Upper deviation	Lower deviation
30	50	0	-9	7	5	8		
50	80	0	-11	8	6	8		
80	120	0	-13	10	7	9		
120	150	0	-15	11	8	10		
150	180	0	-18	14	9	10		
180	250	0	-20	15	10	11		
250	315	0	-25	19	13	13		

Width deviation
ΔC_s is identical
with ΔB_s of the
corresponding
inner ring.

Tab. 26 Tolerances for inner ring of tapered roller bearings in P4

μ m

d mm		Δd _{mp}		Δd _s		V _{dsp}	V _{dmp}	K _{ia}	S _d	S _{ia}	ΔB _s		ΔT _s	
From	to	Upper deviation	Lower deviation	Upper deviation	Lower deviation	max					Upper deviation	Lower deviation	Upper deviation	Lower deviation
18	30	0	-6	0	-6	5	4	3	4	4	0	-200	+200	-200
30	50	0	-8	0	-8	6	5	4	4	4	0	-240	+200	-200
50	80	0	-9	0	-9	7	5	4	5	4	0	-300	+200	-200
80	120	0	-10	0	-10	8	5	5	5	5	0	-400	+200	-200
120	180	0	-13	0	-13	10	7	6	6	7	0	-500	+350	-250
180	250	0	-15	0	-15	11	8	8	7	8	0	-600	+350	-250

Tab. 27 Tolerances for outer ring of tapered roller bearings in P4

μ m

D mm		ΔD _{mp}		ΔD _s		V _{Dsp}	V _{Dmp}	K _{ea}	S _D	S _{ea}	ΔC _s	
From	to	Upper deviation	Lower deviation	Upper deviation	Lower deviation	max					Upper deviation	Lower deviation
30	50	0	-7	0	-7	5	5	5	4	5		
50	80	0	-9	0	-9	7	5	5	4	5		
80	120	0	-10	0	-10	8	5	6	5	6		
120	150	0	-11	0	-11	8	6	7	5	7		
150	180	0	-13	0	-13	10	7	8	5	8		
180	250	0	-15	0	-15	11	8	10	7	10		
250	315	0	-18	0	-18	14	9	11	8	10		

Width deviation
ΔC_s is identical
with ΔB_s of the
corresponding
inner ring.

Tab. 28 Tolerances for inner ring of ball screw support bearings in P4

μ m

d mm		Δd _{mp}		Δd _s		V _{dsp}	V _{dmp}	K _{ia}	S _d	S _{ia}	ΔB _s			V _{BS}
From	to	Upper deviation	Lower deviation	Upper deviation	Lower deviation	max					Upper deviation	Lower deviation		max
											All	Normal	Revise	
10	18	0	-4	0	-4	3	2	2.5	3	2	0	-80	-250	2.5
18	30	0	-5	0	-5	4	2.5	3	4	2	0	-120	-250	2.5
30	50	0	-6	0	-6	5	3	4	4	2	0	-120	-250	3
50	80	0	-7	0	-7	5	3.5	4	5	3	0	-150	-250	4
80	120	0	-8	0	-8	6	4	5	5	3	0	-200	-380	4
120	150	0	-10	0	-10	8	5	6	6	4	0	-250	-380	5

Notes: (1) For the deviation of a single inner ring width matched in pair or group.

Tab. 29 Tolerances for outer ring of ball screw support bearings in P4

μ m

D mm		ΔD _{mp}		ΔD _s		V _{Dsp}	V _{Dmp}	K _{ea}	S _D	S _{ea}	ΔC _s		V _{Cs}
From	to	Upper deviation	Lower deviation	Upper deviation	Lower deviation	max					Upper deviation	Lower deviation	max
18	30	0	-5	0	-5	4	2.5	4	4	2			2.5
30	50	0	-6	0	-6	5	3	5	4	2			2.5
50	80	0	-7	0	-7	5	3.5	5	4	3			3
80	120	0	-8	0	-8	6	4	6	5	3	Width deviation ΔC _s is identical with ΔB _s of the corresponding inner ring.		4
120	150	0	-9	0	-9	7	5	7	5	4			5
150	180	0	-10	0	-10	8	5	8	5	4			5
180	250	0	-11	0	-11	8	6	10	7	4			7
250	315	0	-13	0	-13	10	7	11	8	5			7

Tab. 30 Tolerances for inner ring of ball screw support bearings in P2

μ m

d mm		Δd _{mp}		Δd _s		V _{dsp}	V _{dmp}	K _{ia}	S _d	S _{ia}	ΔB _s			V _{BS}
From	to	Upper deviation	Lower deviation	Upper deviation	Lower deviation	max					Upper deviation	Lower deviation		max
											All	Normal	Revise	
10	18	0	-2.5	0	-2.5	2.5	1.5	1.5	1.5	2	0	-80	-250	1.5
18	30	0	-2.5	0	-2.5	2.5	1.5	2.5	1.5	2	0	-120	-250	1.5
30	50	0	-2.5	0	-2.5	2.5	1.5	2.5	1.5	2	0	-120	-250	1.5
50	80	0	-4	0	-4	4	2	2.5	1.5	3	0	-150	-250	1.5
80	120	0	-5	0	-5	5	2.5	2.5	2.5	3	0	-200	-380	2.5
120	150	0	-7	0	-7	7	3.5	2.5	2.5	4	0	-250	-380	2.5

Notes: (1) For the deviation of a single inner ring width matched in pair or group.

Tab. 31 Tolerances for outer ring of ball screw support bearings in P2

 μm

D mm		ΔD_{mp}		ΔD_s		V_{Dsp}	V_{Dmp}	K_{ea}	S_D	S_{ea}	ΔC_s		V_{cs}
From	to	Upper deviation	Lower deviation	Upper deviation	Lower deviation	max					Upper deviation	Lower deviation	max
18	30	0	-4	0	-4	4	2	2.5	1.5	2			1.5
30	50	0	-4	0	-4	4	2	2.5	1.5	2			1.5
50	80	0	-4	0	-4	4	2	4	1.5	3	Width deviation ΔC_s is identical with ΔB_s of the corresponding inner ring.		1.5
80	120	0	-5	0	-5	5	2.5	5	2.5	3			2.5
120	150	0	-5	0	-5	5	2.5	5	2.5	4			2.5
150	180	0	-7	0	-7	7	3.5	5	2.5	4			2.5
180	250	0	-8	0	-8	8	4	7	4	4			4
250	315	0	-8	0	-8	8	4	7	5	5			5

2.3 The limiting speed

The limiting speed of angular contact ball bearings is the highest in all rolling bearings under the same condition.

The limiting speed of rolling bearings depends on the structure types, dimensional series, dimensional sizes, cage materials and structures, bearing accuracy, internal clearance, preload, external load, lubrication methods and conditions, allowable working temperature, cooling measures, the accuracy of fitting shaft and housing, etc. The limiting speeds in the condition of grease lubrication and oil (oil air or oil mist) lubrication, listed in the catalog, are only for reference. The speed values are appropriate for the following conditions:

(1) Bearing accuracy: The accuracy of angular contact ball bearings and ball screw support bearings is in Class P4, the accuracy of cylindrical roller bearings and double-direction angular contact thrust ball bearings is in Class SP, the accuracy of tapered roller bearings is in Class P5.

(2) It' s used for single bearing with light preload.

(3) The bearing should be mounted with shaft and housing appropriate fitting, rotating parts should have good dynamic balance.

(4) For the grease lubrication bearings, should with high quality and appropriate amount lubricating grease.

(5) The lubricating oil keeps excellent performance, suitable viscosity and sufficient amount.

(6) The load of bearings can not be excessive and bearing running at the normal working temperature.

The limiting speeds given in the catalogue are the maximum speeds under ideal conditions, while the actual speeds are generally lower than the given value according to the variety of conditions

The limiting speeds of matched bearing are determined by matching methods, preload level, and bearing accuracy class. The limiting speeds of matched bearing will be reduced with the reduction coefficient in the Tab. 32.

Table 32. The reduction coefficient of limiting speed

Matched methods	Preload level	Reduction coefficient
DT		0.9
DB、DF	A	0.8
	B	0.7
	C	0.55
TBT、TFT	A	0.7
	B	0.55
	C	0.35
QBC、QFC	A	0.75
	B	0.6
	C	0.45

- Note: 1. This table only for ZYS P4 bearings made with GCr15;
2. If Tolerance class is P4A or P2, to multiply accuracy coefficient of 1.2;
3. If material is ZYS special high purity bearing steel ZGCr15, to multiply material coefficient of 1.1;

2.4 Rigidity

With the external load, elastic deformation will be generated in the contact area between rolling elements and raceway, thus the non-deformability is called the rigidity of bearing.

Without any loads, the contacts between rolling elements and raceway including point contact and line contact, no matter which kind of contacts, the contact area always increases with the load increases, therefore, there is no linear relationship between the approaching amount of two contacting parts and load, that is, the rigidity of bearing is not constant, it varies with the load. In general, the rigidity increases as the load increases.

Angular contact ball bearings are usually used to support axial load, the bigger the contact angle is, the greater the axial load capacity is and the higher the corresponding axial rigidity is. To impose appropriate preload can increase the bearing rigidity. In addition, angular contact ball bearings can also raise the radial and axial rigidity of bearing through suitable matching.

The number of rolling elements has much greater influence on bearing rigidity than the rolling elements size does. For the bearings with same bore diameter, though the rolling elements of the bearings in 19、(1)0 diameter series are small, the number of assembled rolling elements is large, in this way higher rigidity can also be reached. Therefore, the angular contact ball bearings used in high-speed precision machine tool spindle usually use 19、(1)0 diameter series.

Select cylindrical roller bearings, when the higher radial rigidity is required.

3 Load rating and rating life

3.1 Static load rating

Static load rating refers to the central static axial load or static radial load, caused through the rolling elements which endure maximum load contacting with raceway and equivalent to the following contact stresses.

Self-aligning ball bearings: 4600MPa

All the other ball bearings: 4200 MPa

All roller bearings: 4000 MPa

Maximum deformation of rolling element and raceway generated under the above contact forces is 0.0001 times the diameter of rolling element of bearing.

As for the bearing sets composed of i sets of same angular contact bearings, the static load rating of the bearing sets is i times that of single bearing.

3.2 Static equivalent load

3.2.1 Static equivalent radial load

The static equivalent radial load of angular contact ball bearings can be calculated with the following formulas, and the biggest value should be preferred.

$$P_{0r} = X_0 \cdot F_r + Y_0 \cdot F_a$$

$$P_{0r} = F_r$$

In the formula: P_{0r} —static equivalent radial load, N

X_0 —the coefficient of static radial load (shown in the Tab. 33)

Y_0 —the coefficient of static axial load (shown in the Tab. 33)

F_r —the bearing radial load, or the radial component of practical bearing load, N.

F_a —the bearing axial load, or the axial component of practical bearing load, N.

Tab. 33 Coefficients X_0 and Y_0 of angular contact ball bearings

Contact angle	X_0	Y_0
15°	0.5	0.46
25°	0.5	0.38

The static equivalent radial load of cylindrical roller bearings

$$P_{0r} = F_r$$

3.2.2 Static equivalent axial load

As for the ball screw support ball bearings with 60° contact angle, its static equivalent axial load is calculated with the following formulas:

$$P_{0a} = 2.3F_r \tan \alpha + F_a \quad \text{i.e. } P_{0a} = 4F_r + F_a$$

As for the double-direction angular contact thrust ball bearings, its static equivalent axial load,

$$P_{0a} = F_a$$

3.3 Safety factor of static load

According to the bearing running smoothness, friction requirements and the geometry of actual contact surface, the allowed static equivalent load can be less than, equal to or greater than the static load rating. But for high-speed precision bearings, the ratio of recommended static load rating and static equivalent load should not be less than 3.

3.4 Dynamic load rating

Dynamic load rating refers to the hypothetical constant radial load or constant central axial load which a set of rolling bearing can support, under this load the basic rating life of the bearing is 1 million revolutions.

For single row angular contact ball bearings, the load refers to the radial load component causing the single radial displacement between the bearing rings.

For ball screw support bearings, the dynamic load rating refers to the axial load component causing the single axial displacement between the bearing rings.

3.5 Dynamic equivalent load

3.5.1 Dynamic equivalent radial load

The dynamic equivalent radial load of angular contact ball bearings:

$$P_r = X \cdot F_r + Y \cdot F_a$$

In the formula, P_r —refers to dynamic equivalent radial load, N.

X —refers to the coefficient of dynamic radial load (shown in the Tab. 34)

Y —refers to the coefficient of dynamic axial load (shown in the Tab. 34)

F_r —refers to the bearing radial load, or the radial component of practical bearing load, N.
 F_a —refers to the bearing axial load, or the axial component of practical bearing load, N.

Tab. 34 Coefficients X and Y of angular contact ball bearings

Contact angle	F_a/C_{or}	e	$F_a/F_r \leq e$		$F_a/F_r > e$	
			X	Y	X	Y
15°	0.015	0.38	1	0	0.44	1.47
	0.029	0.40	1	0	0.44	1.40
	0.058	0.43	1	0	0.44	1.30
	0.087	0.46	1	0	0.44	1.23
	0.12	0.47	1	0	0.44	1.19
	0.17	0.5	1	0	0.44	1.12
	0.29	0.55	1	0	0.44	1.02
	0.44	0.56	1	0	0.44	1.00
	0.58	0.56	1	0	0.44	1.00
25°	—	0.68	1	0	0.41	0.87

For one set of preloaded angular contact ball bearings,

(1) If the bearings only supports external radial load, F_a is equal to F_{a0} , the preload.

(2) If the bearings supports external radial load F_r' and axial load F_a'

When this set of bearings is rigid preload, if $F_a' \leq 3F_{a0}$, $F_a = \frac{2}{3} F_a' + F_{a0}$

if $F_a' > 3F_{a0}$, $F_a = F_a'$

When this set of bearings is spring preload, $F_a = F_a' + F_{a0}$

The dynamic equivalent radial load of cylindrical roller bearings:

$$P_r = F_r$$

3.5.2 Dynamic equivalent axial load

Ball screw support bearings mainly support axial load, when bear the combined loads, radial load F_r' and axial load F_a' , generally, $F_r' < 0.47F_a'$, therefore, the dynamic equivalent axial load of ball screw support bearings: $P_a = F_a'$.

In the same way, since double-direction angular contact thrust ball bearings only support axial load F_a' , the dynamic equivalent axial load of this kind of bearing: $P_a = F_a'$.

3.6 Basic rating life

For single bearing or group of bearings runs under the same condition, the basic rating life is relevant to 90% reliability, usual materials, manufacturing quality and conventional running conditions.

The basic rating life of matched angular contact ball bearings:

$$L_{10} = i^{2.1} \left(\frac{C_r}{P_r} \right)^3 \quad (\text{million revolutions})$$

$$\text{或 } L_{10h} = i^{2.1} \left(\frac{C_r}{P_r} \right)^3 \times \frac{10^6}{60n} \quad (\text{hours})$$

In the formula, i —The number of bearings in one group.

C_r —Dynamic radial load rating of single piece of bearing, N.

P_r —Dynamic equivalent radial load of single piece of bearing, N.

n —Rotating speed, r/min.

For double-direction angular contact thrust ball bearings and ball screw support bearings, adopt axial load to calculate the life.

For cylindrical roller bearings, the basic rating life is

$$L_{10} = \left(\frac{C_r}{P_r} \right)^{10/3} \text{ (million revolutions)}$$

$$\text{或 } L_{10h} = \left(\frac{C_r}{P_r} \right)^{10/3} \times \frac{10^6}{60n} \text{ (hours)}$$

The above calculated life refers to the fatigue life of bearings. For high-speed precision spindle bearings, its life generally refers to the life of accuracy, i.e. how long the accuracy can be kept. As the precision bearing is being used, the wear of the rolling elements, ring raceway and cages make the bearing accuracy decrease, then the bearing can be discarded. Although no fatigue damage appears on the bearing at that time, we still think this bearing life has come to the end. Therefore, the calculation of bearing fatigue life can be considered as a reference for the working life of high-speed precision bearing.

4 Preload and rigidity

High-speed spindle bearings and ball screw support bearings, in normal working condition, should be preloaded with axial load, aiming at improving bearing running accuracy, reducing rolling elements' sliding in high speed, increasing bearing rigidity, decreasing the axial and radial movement of support, increasing bearing damping, reducing noise, increasing bearing service life, etc.

4.1 The preload and rigidity of angular contact ball bearings

The usual offered preloads of angular contact ball bearings are Light (A), Medium (B) and High (C). Moreover, we can provide bearings with special preload value on customers' request.

Bearing preloads with position preload and constant pressure preload, shown in Fig. 13 and Fig. 14.

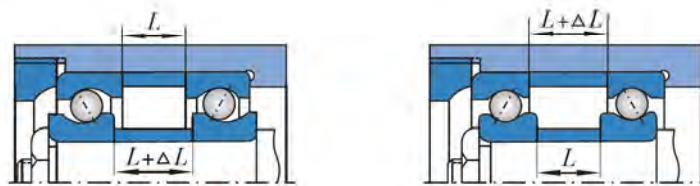

Fig. 13 Position preload

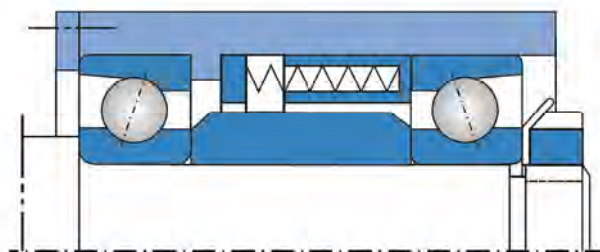

Fig. 14 Constant pressure preload

As the position preload bearing running, the relative position of parts in supporting is fixed. While the angular contact ball bearings running in high speed, the balls tend to be thrown out due to the centrifugal force, which makes the inner ring and outer ring tend to move relatively in axial direction. However, since the position has been relatively constant, the bearing preload will be enlarged and the friction heat will be intensified. Moreover, with the change of working temperature, the housing dimension and the positioning components dimension will also change, and then bearing preload will be affected. Therefore, pay attention to the effect that the change of preload plays on bearing working performance, while adopting the position preload.

The constant pressure preload is to make use of coil spring, butterfly spring and other elastic components to make the bearing preloaded properly in the supporting position. Since the rigidity of spring is usually much smaller than that of bearing, the constant pressure preload is decided by the preload devices. Moreover, the

preload of bearing will not be affected by the working temperature.

All in all, the fixed position preload is good for improving bearing rigidity, while the constant pressure preload is suitable for high-speed running occasions.

The actual bearing preload is decided by the bearing dimension series, contact angles, size dimensions, etc. The preload values of angular contact ball bearings paired in DB or DF have been shown in the following tables from Tab. 35 to Tab. 39. While to obtain the preload values of multiple bearing sets is to use the preload values shown in the tables from Tab. 35 to Tab. 39 multiply the preload coefficient in Tab. 40.

Tab. 35 Preload of 70000 C Series Bearings Matched in DB or DF (N)

N

d mm	718 C			719 C			70 C			72 C		
	Preload level											
	A	B	C	A	B	C	A	B	C	A	B	C
8				10	30	60	16	50	100	23	70	140
10	10	30	60	13	40	80	23	70	140	35	100	200
12	11	33	66	15	45	90	27	80	160	35	100	200
15	12	36	72	24	70	140	30	90	180	48	140	280
17	12	36	72	26	80	160	40	120	240	60	180	360
20	20	60	120	40	120	240	50	150	300	70	210	420
25	22	66	130	40	120	240	65	190	380	90	270	540
30	22	66	130	42	125	250	80	240	480	120	360	720
35	25	75	150	58	175	350	100	300	600	135	400	800
40	26	78	155	74	220	440	105	310	620	180	540	1080
45	27	80	160	80	240	480	140	420	840	187	560	1120
50	40	120	240	100	300	600	145	430	860	225	670	1340
55	55	165	330	125	375	750	195	580	1160	290	870	1740
60	70	210	420	130	390	780	200	600	1200	305	910	1820
65	70	210	420	135	400	880	210	630	1260	355	1060	2120
70	73	220	440	185	550	1100	270	810	1620	370	1110	2220
75	76	225	450	185	550	1100	275	820	1640	385	1150	2300
80	78	230	460	190	570	1140	330	990	1980	460	1380	2760
85	115	345	690	245	730	1460	340	1000	2000	515	1540	3080
90	116	350	700	250	750	1500	360	1050	2100	655	1960	3920
95	116	350	700	255	760	1520	420	1250	2500	655	1960	3920
100	120	360	720	320	960	1900	430	1290	2580	770	2310	4620
105	130	390	780	330	990	1980	500	1500	3000	890	2670	5340
110	160	480	960	330	990	1980	590	1750	3500	920	2760	5340
120	180	540	1080	390	1170	2340	600	1800	3600	950	2850	5700
130	210	620	1240	400	1200	2400	750	2200	4400	1050	3100	6200
140	240	720	1440	420	1250	2500	800	2400	4800	1200	3600	7200
150	270	810	1620	630	1900	3800	900	2700	5400	1280	3800	7600
160	280	840	1680	660	1950	3900	1000	3000	6000	1330	4000	8000
170	350	1000	2000	670	2000	4000	1100	3300	6600	1600	4800	9600
180	370	1110	2220	850	2500	5000	1200	3600	7200	1660	4900	9800
190	420	1260	2520	870	2600	5200	1300	3800	7600	1700	5100	10200
200	430	1290	2580	1000	3000	6000	1600	4800	9600	1760	5300	10600
220	440	1320	2640	1100	3300	6600	1800	5400	10800	2170	6500	13000
240	560	1680	3360	1150	3400	6800	1900	5700	11400			
260	560	1680	3360	1500	4500	9000						
280	690	2070	4140	1550	4600	9200						
300	900	2700	5400									
320	920	2760	5520									
340	940	2820	5640									
360	960	2880	5760									

Tab. 36 Preload of 70000 AC series bearings matched in DB or DF (N)

N

d mm	718 AC			719 AC			70 AC			72 AC		
	Preload level											
	A	B	C	A	B	C	A	B	C	A	B	C
8				16	48	95	25	80	160	35	105	210
10	16	48	95	22	65	130	35	100	200	55	160	320
12	17	50	100	26	80	160	45	130	260	60	180	360
15	19	57	115	41	120	240	50	150	300	80	240	480
17	20	60	120	43	130	260	65	190	380	95	280	560
20	32	95	190	62	185	370	80	240	480	115	340	680
25	35	105	210	64	190	380	105	310	620	150	450	900
30	37	110	220	67	200	400	130	390	780	200	600	1200
35	39	115	230	93	280	560	165	490	980	220	660	1320
40	40	120	240	120	360	720	170	510	1020	295	880	1760
45	40	120	240	125	370	740	230	690	1380	300	900	1800
50	60	180	360	160	480	960	235	700	1400	365	1090	2180
55	87	260	520	200	600	1200	315	940	1880	460	1380	2760
60	114	340	680	210	630	1260	325	970	1940	480	1440	2880
65	115	345	690	210	630	1260	330	990	1990	570	1710	3420
70	117	350	700	290	870	1740	425	1270	2540	590	1770	3540
75	120	360	720	300	900	1800	435	1300	2600	615	1840	3680
80	123	370	740	300	900	1800	525	1570	3140	750	2250	4500
85	183	550	1100	390	1170	2340	540	1620	3240	825	2470	4940
90	184	550	1100	400	1200	2400	570	1710	3420	1050	3150	6300
95	186	560	1120	400	1200	2400	670	2010	4020	1050	3150	6300
100	190	570	1140	510	1530	3060	690	2070	4140	1240	3720	7440
105	200	600	1200	520	1560	3120	800	2400	4800	1430	4290	8580
110	260	780	1560	530	1590	3180	950	2850	5700	1480	4440	8880
120	280	850	1700	620	1860	3720	970	2910	5820	1500	4500	9000
130	320	950	1900	640	1900	3800	1200	3600	7200	1600	4800	9600
140	380	1140	2280	660	2000	4000	1300	3900	7800	1900	5700	11400
150	430	1260	2500	1000	3000	6000	1400	4200	8400	2050	6100	12200
160	450	1350	2700	1050	3100	6200	1600	4800	9600	2100	6300	12600
170	550	1650	3300	1070	3200	6400	1750	5200	10000	2500	7500	15000
180	600	1800	3600	1350	4000	8000	1950	5800	11500	2650	7900	15800
190	670	2000	4000	1380	4100	8200	2000	6000	12000	2700	8100	16200
200	680	2040	4080	1690	5000	10000	2500	7500	15000	2800	8400	16800
220	700	2100	4200	1750	5200	10400	2800	8400	16800	3400	10000	20000
240	880	2640	5280	1850	5500	11000	3000	9000	18000			
260	900	2700	5400	2420	7200	14400						
280	1110	3330	6660	2440	7300	14600						
300	1440	4320	8640									
320	1480	4440	8880									
340	1520	4560	9120									
360	1550	4650	9300									

Tab. 37 Preload of H70000 (/HQ1) and H70000-DL (/HQ1) series bearings matched in DB or DF (N)

N

d mm	H719 C H719 C/HQ1 H719 C-DL H719 C-DL/HQ1			H70 C H70 C/HQ1 H70 C-DL H70 C-DL/HQ1			H719 AC H719 AC/HQ1 H719 AC-DL H719 AC-DL/HQ1			H70 AC H70 AC/HQ1 H70 AC-DL H70 AC-DL/HQ1		
	Preload level											
	A	B	C	A	B	C	A	B	C	A	B	C
8	9	27	55	15	35	75	17	50	100	24	72	145
10	11	33	65	16	48	95	18	54	105	30	90	180
12	13	39	78	21	63	125	21	63	125	34	100	200
15	19	57	115	24	72	145	31	93	185	40	120	240
17	20	60	120	27	80	160	33	99	200	43	130	260
20	29	87	175	40	120	240	48	145	290	65	190	380
25	32	96	190	50	150	300	52	155	310	75	210	420
30	36	105	210	65	190	380	57	170	340	90	270	540
35	47	140	280	65	190	380	75	220	440	100	300	600
40	51	150	300	70	210	420	82	240	480	110	330	660
45	53	160	320	80	240	480	85	250	500	125	370	740
50	69	205	410	85	250	500	110	330	660	135	400	800
55	85	250	500	95	280	560	135	400	800	155	460	920
60	90	270	540	100	300	600	140	420	840	160	480	960
65	90	270	540	115	340	680	140	420	840	185	550	1100
70	110	330	660	135	400	800	170	510	1020	210	630	1260
75	110	330	660	140	420	840	180	540	1080	225	670	1340
80	115	345	690	185	550	1100	185	550	1100	290	870	1740
85	135	400	800	190	570	1140	215	640	1280	300	900	1800
90	140	420	840	195	580	1160	225	670	1340	310	930	1860
95	140	420	840	240	720	1440	225	670	1340	390	1170	2340
100	210	630	1260	245	730	1460	330	990	1980	400	1200	2400
105	210	630	1260	250	750	1500	335	1000	2000	400	1200	2400
110	215	640	1280	255	760	1520	340	1020	2040	410	1230	2460
120	225	670	1340	315	940	1880	360	1080	2160	500	1500	3000
130	240	720	1440	320	960	1900	380	1140	2280	500	1500	3000
140	245	730	1460	330	990	2000	390	1170	2340	520	1560	3120
150	300	900	1800	400	1200	2400	480	1440	2880	630	1890	3780
160	300	900	1800	410	1230	2460	480	1440	2880	650	1950	3900
170	310	930	1860	420	1260	2520	500	1500	3000	660	1980	3960
180	360	1100	2200	430	1290	2580	580	1740	3480	680	2040	4080
190	370	1110	2220	510	1530	3060	590	1770	3540	800	2400	4800
200	380	1140	2280	520	1560	3120	610	1830	3660	820	2460	4920
220	440	1320	2640	600	1800	3600	700	2100	4200	940	2820	5640

Tab. 38 Preload of HS70000 (/HQ1) and B70000 -2RZ (/HQ1) series bearings matched in DB or DF (N)

N

d mm	HS719 C HS719 C/HQ1 B719 C-2RZ B719 C-2RZ/HQ1			HS70 C HS70 C/HQ1 B70 C-2RZ B70 C-2RZ/HQ1			HS719 AC HS719 AC/HQ1 B719 AC-2RZ B719 AC-2RZ/HQ1			HS70 AC HS70 AC/HQ1 B70 AC-2RZ B70 AC-2RZ/HQ1		
	Preload level									A	B	C
	A	B	C	A	B	C	A	B	C	A	B	C
10	7	21	42	9	27	54	11	33	66	15	45	90
12	7	21	42	9	27	54	11	33	66	15	45	90
15	9	27	54	13	39	78	15	54	90	20	60	120
17	10	30	60	13	39	78	16	48	96	21	63	125
20	13	39	78	21	63	125	21	63	125	34	102	200
25	14	42	84	21	63	125	23	69	140	35	105	210
30	21	63	125	29	87	175	35	105	210	48	145	290
35	24	72	145	32	96	190	38	115	230	51	150	300
40	25	75	150	34	108	215	40	120	240	54	160	320
45	34	102	205	44	132	265	55	165	330	71	210	420
50	35	105	210	46	138	275	58	175	350	74	220	440
55	46	138	275	64	190	380	75	225	450	105	310	620
60	48	145	290	67	200	400	78	235	470	105	310	620
65	49	147	295	70	210	420	80	240	480	110	330	660
70	64	192	385	89	270	540	103	310	620	145	430	860
75	65	195	395	91	270	540	105	315	630	150	450	900
80	73	220	440	110	330	660	120	360	720	175	520	1040
85	76	228	455	110	330	660	125	375	750	180	540	1080
90	83	250	500	130	390	780	130	390	780	210	630	1260
95	85	255	510	130	390	780	140	420	840	210	630	1260
100	102	305	610	135	400	800	165	490	980	215	640	1280
105	104	310	620	170	510	1020	170	510	1020	275	820	1640
110	120	360	720	175	520	1040	195	580	1160	280	840	1680
120	127	380	760	180	540	1080	205	610	1220	290	870	1740
130	145	430	860	230	690	1380	240	720	1440	360	1080	2160
140	150	450	900	235	700	1400	245	730	1460	370	1110	2220
150	215	640	1280	280	840	1680	350	1050	2100	440	1320	2640
160	220	650	1300	310	930	1860	360	1080	2160	500	1500	3000
170	250	750	1500	350	1050	2100	410	1230	2460	550	1650	3300
180	260	780	1560	380	1140	2280	425	1270	2540	600	1800	3600
190	320	960	1920	450	1350	2700	520	1560	3120	700	2100	4200
200	330	990	1980	460	1380	2760	540	1620	3260	720	2160	4320
220	370	1110	2220	540	1620	3240	600	1800	3600	850	2550	5100

Tab. 39 Preload of B70 C (/HQ1) series bearings matched in DB or DF (N)

d mm	B70 C' B70 C/HQ1		
	Preload level		
	A	B	C
10	20	60	120
12	22	66	132
15	26	78	156
17	26	78	156
20	41	123	245
25	55	165	330
30	65	195	390
35	76	230	460
40	92	280	560
45	110	330	660
50	110	330	660
55	145	430	860
60	145	430	860

Tab. 40 Preload coefficient of multiple bearing sets

Matching method	Preload coefficient
TBT, TFT	1.35
QBT, QFT	1.60
QBC, QFC	2.00

For the machine tool in normal speed (d_{mn} is not more than $6 \times 10^5 \text{ mm} \cdot \text{r/min}$, d_m is the bearing pitch diameter, n is bearing running speed), the bearing preload can be decided according to the additional axial load that the bearing supports. The minimum preload of matched bearings refers to the bearing in the group which not bears support just unload, that is the bearing's rolling elements are swimming on the ring raceway under the additional axial load. The minimum preload of matched bearing change with the different direction of additional axial load. The relationship between the minimum preload of some common used matched bearings, $F_{a0\min}$ and the additional axial load F_{am} has shown in Tab. 41. Moreover, when the preload of matched bearing F_{a0} is given, the maximum additional axial load $F_{am\max}$ can be obtained according to the following Tab. 41.

 Tab. 41 Relationship between matched bearing preload F_{a0} and additional axial load F_{am}

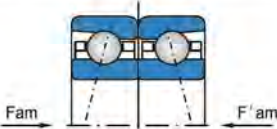
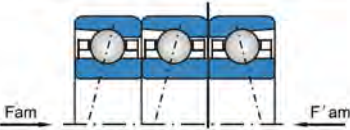
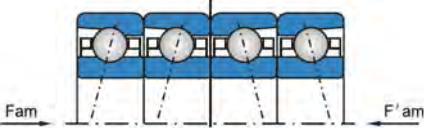
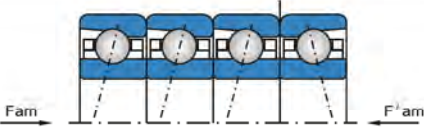
Bearing arrangements	Relationship between F_{a0} and F_{am}
	$F_{a0\min} = 0.35F_{am}$ $F_{am\max} = 2.83F_{a0}$ $F_{a0\min} = 0.35F'_{am}$ $F'_{am\max} = 2.83F_{a0}$
	$F_{a0\min} = 0.24F_{am}$ $F_{am\max} = 4.16F_{a0}$ $F_{a0\min} = 0.48F'_{am}$ $F'_{am\max} = 2.08F_{a0}$
	$F_{a0\min} = 0.35F_{am}$ $F_{am\max} = 2.83F_{a0}$ $F_{a0\min} = 0.35F'_{am}$ $F'_{am\max} = 2.83F_{a0}$
	$F_{a0\min} = 0.19F_{am}$ $F_{am\max} = 5.4F_{a0}$ $F_{a0\min} = 0.56F'_{am}$ $F'_{am\max} = 1.8F_{a0}$

The axial rigidity of matched angular contact bearings is defined as the ratio of limited axial load F_{amax} and the corresponding axial deformation when axial force is presumed as preload F_{a0} .

For the ZYS precision angular contact ball bearings matched in DB and DF, the axial rigidity is shown from Tab. 42 to Tab. 48.

Tab. 42 Axial rigidity R_a of 70000 C series bearings matched in DB or DF

N/ μ m

d mm	718 C			719 C			70 C			72 C		
	Preload level											
	A	B	C	A	B	C	A	B	C	A	B	C
8				10	14	17	11	16	20	12	18	22
10	10	14	17	12	17	21	14	20	25	16	23	29
12	11	16	20	14	19	25	16	22	28	18	25	32
15	13	19	24	17	24	31	19	26	33	20	29	37
17	14	20	25	18	26	33	20	29	36	23	32	41
20	18	26	34	23	33	42	24	35	44	27	39	49
25	21	30	38	24	35	44	29	42	53	32	46	58
30	24	34	43	27	38	49	35	50	63	38	55	69
35	26	37	47	33	47	60	39	56	71	44	63	79
40	28	40	51	37	53	68	41	59	75	50	72	92
45	30	43	54	40	58	74	46	67	85	53	77	97
50	36	51	65	47	68	86	49	71	89	57	82	104
55	41	60	75	54	78	99	56	81	103	63	91	116
60	47	67	85	58	84	106	59	85	108	67	97	123
65	48	69	87	60	86	109	62	90	114	74	107	136
70	50	73	92	69	99	126	70	102	129	78	113	143
75	53	76	97	71	102	130	74	106	135	82	119	151
80	55	80	101	73	106	134	78	113	144	90	130	165
85	62	89	113	82	118	150	82	119	150	93	134	169
90	63	92	116	84	122	154	89	129	163	110	160	202
95	65	94	119	87	126	159	94	137	173	107	154	195
100	68	99	125	95	138	175	98	142	180	114	165	208
105	70	101	127	98	143	180	103	149	189	121	175	221
110	78	114	144	101	147	186	112	162	205	127	184	233
120	84	122	154	106	154	194	116	169	213	133	193	245
130	91	132	167	112	163	206	129	187	236	139	202	255
140	98	142	180	119	172	218	134	194	246	152	221	279
150	105	153	193	129	188	237	143	207	262	158	229	290
160	110	159	202	138	200	254	151	220	278	165	240	303
170	122	177	224	142	207	261	158	230	291	173	251	318
180	130	187	235	154	224	283	172	250	317	181	264	334
190	132	189	237	159	231	292	179	260	328	190	276	349
200	136	197	248	168	245	309	186	270	342	198	288	365
220	142	205	259	180	261	330	198	288	365	216	314	397
240	154	222	279	196	286	361	215	312	395			
260	162	234	295	213	311	393						
280	176	253	319	220	320	404						
300	194	280	353									
320	203	293	370									
340	212	306	386									
360	221	319	402									

Tab. 43 Axial rigidity Ra of 70000 AC series bearings matched in DB or DF

 N/ μ m

d mm	718 AC			719 AC			70 AC			72 AC		
	Preload level									A	B	C
	A	B	C	A	B	C	A	B	C			
8				25	35	44	28	42	54	30	45	56
10	26	35	44	31	43	54	37	51	64	42	59	74
12	30	42	52	37	51	64	41	57	72	47	66	83
15	35	49	61	45	62	78	49	69	86	53	74	94
17	37	52	65	48	67	84	53	74	94	60	83	105
20	49	69	86	61	85	107	64	90	113	72	100	126
25	56	78	99	64	90	113	77	108	136	85	119	150
30	63	88	111	71	100	125	92	128	161	101	141	178
35	69	96	121	87	121	152	104	146	183	116	162	204
40	75	106	133	98	138	173	109	153	193	134	187	235
45	79	110	139	107	150	189	123	172	216	142	199	250
50	95	134	168	125	175	220	130	182	229	151	212	267
55	111	155	195	144	201	253	150	210	264	169	236	297
60	125	175	220	155	217	272	158	221	278	179	251	316
65	127	179	225	159	224	281	165	232	292	198	277	348
70	134	189	237	183	257	323	188	263	331	209	293	368
75	141	199	250	189	266	334	197	276	346	220	309	388
80	148	208	261	195	274	344	209	294	369	240	338	424
85	166	233	292	219	307	386	219	307	386	247	347	436
90	170	239	300	226	317	398	239	335	421	276	394	496
95	174	244	307	233	327	410	253	354	446	286	410	517
100	183	257	323	256	359	451	263	370	464	305	427	537
105	187	263	330	264	371	466	276	387	487	323	454	570
110	211	296	372	272	382	480	299	421	529	341	478	601
120	227	318	400	285	399	502	312	438	550	358	502	631
130	246	345	434	302	424	533	346	485	610	373	525	659
140	265	372	467	320	449	564	350	505	635	410	575	723
150	284	399	501	348	488	613	384	539	677	426	599	753
160	297	417	524	372	522	656	407	572	719	446	627	788
170	329	463	582	383	538	676	427	600	754	468	658	827
180	344	496	625	415	583	733	465	653	821	492	691	869
190	346	498	627	428	602	757	483	678	852	515	724	910
200	359	518	653	454	637	801	504	707	889	538	756	951
220	376	543	684	485	681	856	538	756	951	588	826	1038
240	405	584	735	531	746	938	584	820	1031			
260	431	621	783	579	814	1024						
280	466	672	846	597	839	1054						
300	515	742	935									
320	540	778	981									
340	564	814	1026									
360	588	848	1068									

Tab. 44 Axial rigidity Ra of H70000 and H7000-DLseries bearings matched in DB or DF

N/μm

d mm	H719 C H719 C-DL			H70 C H70 C-DL			H719 AC H719 AC-DL			H70 AC H70 AC-DL		
	Preload level											
	A	B	C	A	B	C	A	B	C	A	B	C
8	7	11	18	11	14	18	18	28	36	28	42	54
10	8	12	19	13	20	25	21	32	41	35	51	64
12	10	14	22	14	22	28	25	38	49	39	56	70
15	12	18	28	16	24	30	30	46	60	42	61	77
17	13	19	30	17	26	33	33	50	65	46	66	83
20	16	24	38	22	34	43	41	63	82	60	87	109
25	18	27	42	26	39	49	46	71	92	69	99	125
30	21	31	49	29	44	55	54	83	107	78	111	140
35	25	36	56	34	52	65	62	95	123	92	131	165
40	28	40	64	37	57	71	70	108	140	101	144	181
45	30	44	69	41	62	78	76	117	150	109	157	198
50	34	49	78	45	68	86	88	131	170	121	173	218
55	37	54	85	48	73	92	95	145	187	130	187	235
60	40	58	92	52	78	99	102	156	202	140	200	252
65	42	60	95	56	86	108	106	162	209	153	219	276
70	46	67	105	61	93	117	117	179	231	166	238	299
75	48	69	109	63	96	121	121	185	239	171	145	309
80	50	71	113	71	108	135	125	191	248	192	275	346
85	55	80	126	73	111	140	140	214	277	198	284	357
90	57	83	130	78	118	148	145	222	286	211	302	380
95	59	85	135	83	126	158	150	229	296	225	322	405
100	65	94	148	85	130	163	164	251	325	232	332	418
105	67	97	153	88	133	168	170	260	336	238	342	430
110	69	100	158	93	141	177	175	269	347	252	362	455
120	77	112	176	101	153	193	196	300	388	274	393	494
130	82	118	187	103	157	197	208	319	412	281	402	506
140	84	121	191	109	165	208	214	327	423	296	424	534
150	93	134	211	120	183	230	236	361	467	328	469	590
160	96	138	217	126	192	241	242	371	480	344	492	620
170	98	141	222	132	200	252	249	381	492	360	515	648
180	107	154	243	137	209	262	272	417	538	375	537	676
190	110	158	249	147	224	281	279	427	552	402	576	725
200	115	166	261	153	233	293	293	448	579	420	601	756
220	125	180	283	166	252	317	318	486	629	455	651	819

Tab. 45 Axial rigidity Ra of H70000/HQ1 series bearings matched in DB or DF

N/μm

d mm	H719 C/HQ1 H719 C-DL/HQ1			H70 C/HQ1 H70 C-DL/HQ1			H719 AC/HQ1 H719 AC-DL/HQ1			H70 AC/HQ1 H70 AC-DL/HQ1		
	Preload level									A	B	C
	A	B	C	A	B	C	A	B	C	A	B	C
8	8	12	20	12	16	22	21	33	42	33	49	63
10	9	13	21	14	22	28	23	36	46	39	57	71
12	11	15	24	16	24	31	28	42	55	44	62	79
15	13	19	31	17	27	34	34	52	67	48	68	86
17	14	21	33	19	29	36	36	56	73	52	74	94
20	18	27	42	25	38	48	46	71	92	68	97	122
25	20	29	46	29	44	55	52	80	103	78	111	140
30	24	34	54	32	49	62	60	93	120	87	125	157
35	27	40	62	38	58	73	70	107	138	103	147	185
40	31	45	71	41	63	79	79	121	156	113	161	203
45	34	49	77	45	69	86	86	131	170	123	176	221
50	38	55	86	50	76	95	96	147	190	135	194	244
55	42	60	94	54	82	103	106	162	210	146	209	263
60	45	65	102	57	87	110	114	175	227	157	225	283
65	47	67	105	63	95	120	118	181	235	171	245	309
70	51	74	116	68	104	131	131	200	259	186	266	335
75	53	77	121	70	107	135	135	207	268	192	275	346
80	55	80	125	79	120	151	140	215	278	215	308	388
85	62	89	139	81	124	155	157	240	310	222	318	400
90	64	92	144	86	131	165	162	248	321	236	338	426
95	66	95	149	92	140	176	168	257	332	252	360	454
100	72	104	163	95	144	182	184	282	364	260	372	468
105	75	108	169	98	148	187	190	291	377	267	383	482
110	77	111	174	103	157	198	197	301	389	283	405	510
120	86	124	195	112	171	215	220	336	435	308	440	554
130	92	132	207	115	175	220	233	357	462	315	451	567
140	94	135	212	121	184	231	240	367	474	332	475	598
150	104	149	234	134	203	256	265	405	524	367	526	662
160	106	153	240	141	213	268	272	416	538	386	552	695
170	109	157	246	147	223	280	279	427	552	404	578	727
180	119	172	269	153	233	292	305	467	604	421	603	758
190	122	176	276	164	249	313	313	479	619	451	646	813
200	128	185	289	171	260	326	329	503	650	471	674	848
220	139	200	314	185	281	354	356	545	705	510	730	919

Tab. 46 Axial rigidity Ra of HS70000 and B70000-2RZ series bearings matched in DB or DF

N/μm

d mm	HS719 C B719 C-2RZ			HS70 C B70 C-2RZ			HS719 AC B719 AC-2RZ			HS70 AC B70 AC-2RZ		
	Preload level											
	A	B	C	A	B	C	A	B	C	A	B	C
10	9	14	19	9	14	19	22	33	43	23	34	45
12	9	15	20	9	14	19	23	35	45	23	34	45
15	10	16	22	12	20	27	26	39	50	33	48	63
17	11	18	24	13	21	28	27	40	52	34	51	66
20	15	24	33	18	28	39	38	57	74	47	69	90
25	18	28	38	19	30	40	43	65	84	48	72	93
30	22	34	47	22	35	48	54	80	104	58	85	111
35	25	40	54	25	39	53	62	93	120	65	96	124
40	28	43	59	27	43	59	68	101	132	72	106	137
45	32	50	68	30	48	65	78	117	152	80	118	153
50	34	53	72	32	51	69	83	124	161	85	125	163
55	38	59	80	38	60	82	93	139	180	100	147	191
60	40	62	85	41	64	87	98	147	190	106	156	203
65	42	65	89	43	67	92	103	155	200	112	166	215
70	48	75	102	47	74	101	118	177	229	124	182	237
75	50	79	107	49	76	104	124	186	241	127	187	243
80	54	84	114	53	83	114	132	197	255	139	205	266
85	57	89	121	55	86	117	141	211	274	143	210	273
90	59	92	125	59	93	127	145	217	282	155	229	297
95	62	96	131	61	96	130	152	228	295	159	235	305
100	67	104	141	62	98	133	164	246	319	163	241	313
105	70	108	147	69	108	147	172	257	332	179	264	343
110	73	113	154	70	110	150	180	269	349	184	271	352
120	79	123	168	74	116	158	195	292	379	193	285	370
130	84	131	178	84	131	179	207	310	402	219	323	420
140	87	136	184	88	138	187	216	323	418	230	339	441
150	96	149	203	96	150	204	237	354	459	251	370	481
160	99	154	210	100	157	214	246	367	476	263	388	503
170	106	166	225	111	174	236	264	394	511	291	429	557
180	112	174	237	116	181	246	277	415	537	303	447	581
190	123	191	260	124	194	264	305	456	591	325	479	623
200	127	198	268	129	202	275	315	471	610	339	500	649
220	136	212	288	140	219	298	339	507	656	367	542	703

Tab. 47 Axial rigidity Ra of HS70000/HQ1 and B70000-2RZ/HQ1 series bearings matched in DB or DF

N/μm

d mm	HS719 C/HQ1 B719 C-2RZ/HQ1			HS70 C/HQ1 B70 C-2RZ/HQ1			HS719 AC/HQ1 B719 AC-2RZ/HQ1			HS70 AC/HQ1 B70 AC-2RZ/HQ1		
	Preload level									A	B	C
	A	B	C	A	B	C	A	B	C	A	B	C
10	10	16	21	10	15	21	25	37	48	26	38	50
12	10	16	22	10	15	21	26	39	50	26	38	50
15	11	18	25	14	22	30	29	43	56	30	54	70
17	12	20	27	15	23	32	30	45	59	39	57	74
20	17	27	37	20	31	43	43	64	83	52	78	101
25	20	31	42	21	33	45	48	72	94	54	80	104
30	24	38	52	25	39	53	60	90	117	65	96	124
35	28	44	60	28	43	59	69	104	135	72	107	139
40	31	48	66	31	48	66	76	114	147	80	119	154
45	36	56	76	34	53	73	88	132	171	89	132	171
50	38	59	80	36	57	77	93	139	181	95	140	182
55	42	66	89	43	67	91	104	155	201	112	165	214
60	44	69	94	45	71	97	110	164	213	119	175	228
65	47	73	99	48	75	102	116	173	225	126	186	241
70	54	84	114	53	83	113	133	199	257	138	204	266
75	56	88	119	54	85	116	140	209	271	142	210	273
80	60	93	126	59	93	127	148	221	286	156	230	299
85	64	99	135	61	95	130	158	237	307	160	236	306
90	66	103	139	66	104	141	163	244	316	174	256	333
95	69	107	146	68	106	145	171	255	331	178	263	342
100	74	116	157	70	109	148	184	276	357	183	270	350
105	77	121	164	77	120	163	192	288	373	201	296	385
110	81	126	172	78	123	167	202	302	391	206	304	395
120	88	137	187	82	129	176	219	328	425	216	319	415
130	94	146	198	93	146	199	233	348	451	246	363	471
140	97	151	205	98	153	209	242	362	469	258	380	494
150	107	166	226	107	167	228	266	398	515	281	415	539
160	110	172	234	112	175	238	275	412	534	295	435	564
170	119	185	251	124	193	263	296	442	573	326	481	624
180	125	194	264	129	202	275	311	465	602	340	501	651
190	137	213	290	138	216	294	342	512	663	365	538	698
200	141	220	299	144	225	307	353	528	684	380	561	728
220	152	237	322	156	244	332	380	568	736	412	608	789

Tab. 48 Axial rigidity R_a of B70 C (/HQ1) series bearings matched in DB or DF

N/μm

d mm	B70 C			B70 C/HQ1		
	Preload level					
	A	B	C	A	B	C
10	14	20	25	16	22	28
12	15	22	28	17	25	31
15	17	25	31	19	28	35
17	18	26	33	20	29	37
20	23	33	42	26	37	47
25	29	41	53	32	46	59
30	33	47	59	37	53	66
35	37	53	66	41	59	74
40	41	60	76	46	67	85
45	45	65	81	50	73	91
50	48	69	87	54	77	97
55	55	79	100	62	88	112
60	57	82	103	64	92	115

For the paired angular contact ball bearings, the radial rigidity can be approximately calculated according to the Tab. 49.

Tab. 49 Radial rigidity R_r of angular contact ball bearings matched in DB or DF.

Contact angle	Radial rigidity R_r
15°	$R_r \approx 6R_a$
25°	$R_r \approx 2R_a$

The axial rigidity R_a of common multiple bearing sets can be approximately obtained by using the axial rigidity R_a of paired angular contact ball bearings to multiply by the coefficients listed in Tab. 50.

Tab. 50 Axial rigidity coefficients of multiple bearing sets

Common bearing matching methods	Axial rigidity coefficient
TBT	1.47
QBC	2

The radial rigidity R_r of common multiple bearing sets can be approximately obtained by using the radial rigidity R_r of paired angular contact ball bearings to multiply by the coefficients listed in Tab. 51.

Tab. 51 Radial rigidity coefficients of multiple bearing sets

Common bearing matching methods	Radial rigidity coefficient
TBT	1.54
QBC	2

4.2 Preload and rigidity of cylindrical roller bearings

When cylindrical roller bearings preloaded in radial direction, the circumscribed circle diameter of rolling elements is roughly more than the outer raceway diameter, in this way, interference is generated in the bearing.

For the cylindrical roller bearings with taper hole on inner ring, to change the position of inner ring on the conical surface can expand the inner ring in radial direction, then change the bearing radial clearance and realize bearing preload.

For high-speed cylindrical roller bearings, the recommended preload is 0 ~ 5 μm , and the preload value can be increased when the bearing is running in low speed. The optimum preload should be determined through test according to bearing dimension, accuracy and working conditions, such as speed, load, lubrication, permitted temperature rise, etc.

The radial rigidity values of ZYS cylindrical roller bearings are shown in the dimension table.

4.3 The preload and rigidity of double-direction angular contact thrust ball bearings

The preload of double-direction angular contact thrust ball bearings is realized through controlling the thickness of spacer between the two shaft washers.

The preload and rigidity of double-direction angular contact thrust ball bearings are shown in Tab. 52. The axial load to which the axial rigidity corresponds is the corresponding bearing dynamic load rating multiplying by 2.2%.

Tab. 52 Preload and rigidity of double-direction angular contact thrust ball bearings

d mm	Preload KN	Axial rigidity KN/ μm	d mm	Preload KN	Axial rigidity KN/ μm	d mm	Preload KN	Axial rigidity KN/ μm
30、32	0.11	0.2	85、88	0.4	0.6	170、176	1.8	1.2
35、47	0.13	0.3	90、93	0.47	0.7	180、187	1.8	1.3
40、42	0.16	0.3	95、98	0.47	0.7	190、197	2.1	1.4
45、47	0.18	0.3	100、103	0.69	0.7	200、207	2.1	1.4
50、52	0.18	0.4	105、109	0.69	0.7	220、228	2.4	1.6
55、57	0.26	0.4	110、114	0.7	0.8	240、248	2.5	1.7
60、62	0.26	0.4	120、124	1.0	0.9	260、269	2.9	1.8
65、67	0.28	0.5	130、135	1.0	0.9	280、289	3.0	1.9
70、73	0.33	0.5	140、145	1.0	1.0	300、310	3.4	2.0
75、78	0.34	0.5	150、155	1.4	1.1	320、330	3.6	2.1
80、83	0.4	0.6	160、165	1.4	1.1	340、350	4.1	2.2

4.4 The preload and rigidity of high-speed angular contact thrust ball bearings

The preload and rigidity of ZYS high-speed angular contact thrust ball bearings 7000×2 A/DB are shown in Tab. 53, while the preload and rigidity of 7000×2 B/DB are shown in Tab. 54.

Tab. 53 Preload and rigidity of high-speed angular contact thrust ball bearings 7000×2 A/DB

d mm	Preload KN		Axial rigidity KN/ μm		d mm	Preload KN		Axial rigidity KN/ μm	
	Extra-light	light	Extra-light	light		Extra-light	light	Extra-light	light
50	0.22	0.46	0.17	0.22	105	0.38	1.82	0.28	0.47
55	0.23	0.60	0.18	0.25	110	0.39	1.87	0.28	0.49
60	0.24	0.65	0.19	0.27	120	0.39	1.98	0.3	0.52
65	0.25	0.69	0.2	0.29	130	0.39	2.53	0.3	0.55
70	0.25	0.91	0.2	0.32	140	0.58	3.19	0.36	0.65
75	0.26	0.94	0.21	0.33	150	0.58	3.69	0.36	0.69
80	0.34	1.10	0.24	0.36	160	0.59	4.08	0.37	0.72
85	0.35	1.13	0.24	0.37	170	0.6	4.21	0.38	0.75
90	0.36	1.66	0.25	0.43	180	0.6	5.20	0.38	0.80
95	0.36	1.72	0.26	0.45	190	0.61	5.37	0.39	0.83
100	0.37	1.77	0.27	0.46	200	0.61	5.99	0.39	0.86

Tab. 54 Preload and rigidity of high-speed angular contact thrust ball bearings 7000 × 2 B/DB

d mm	Preload KN		Axial rigidity KN/μm		d mm	KN		KN/μm	
	Extra-light	light	Extra-light	light		Extra-light	light	Extra-light	light
50	0.33	0.76	0.29	0.39	105	0.57	3.12	0.47	0.85
55	0.35	0.80	0.31	0.41	110	0.58	3.21	0.49	0.87
60	0.37	0.86	0.33	0.44	120	0.61	3.42	0.52	0.93
65	0.39	0.91	0.35	0.47	130	0.61	4.41	0.6	0.98
70	0.39	1.56	0.35	0.56	140	0.81	5.31	0.6	1.14
75	0.4	1.61	0.36	0.59	150	0.82	5.37	0.62	1.16
80	0.51	1.82	0.4	0.63	160	0.83	5.48	0.63	1.18
85	0.52	1.88	0.42	0.65	170	0.85	7.28	0.64	1.33
90	0.53	2.83	0.43	0.77	180	0.85	9.08	0.64	1.45
95	0.55	2.93	0.45	0.79	190	0.87	9.39	0.66	1.50
100	0.56	3.03	0.46	0.82	200	0.87	11.3	0.66	1.60

4.5 The preload and rigidity of tapered roller bearings

When ZYS tapered roller bearings is mounted, it's unnecessary to absolutely depend on the fit between the bearing and shaft or housing to adjust the axial clearance. In general, the ideal axial clearance is zero when the tapered roller bearings are working, in this way, the bearing life can be prolonged. Therefore, there is certain axial clearance, when most of bearings are mounted. When the host machines reach a stable working temperature, the bearing axial clearance will decrease to the expected zero clearance as much as possible.

As for the medium-size machine tool spindle, the axial clearance of tapered roller bearings will be adjusted to 0 ~ 10 μm. If the spindle runs in low speed, the bearing will be preloaded, that is, there is minus clearance, the axial press between rollers and raceway.

4.6 The preload and rigidity of ball screw support bearings

The preload and axial rigidity of ball screw support bearings are shown in Tab. 55 and Tab. 56.

Tab. 55 Preload and axial rigidity of ball screw support bearings (Standard Metric)

Bearing designation ZYS	Preload F_{ao}	Axial rigidity R_a	Bearing designation ZYS	Preload F_{ao}	Axial rigidity R_a
	KN	N/ μ m		KN	N/ μ m
760201TN1	1.4	470	760304TN1	2.9	780
760202TN1	1.4	510	760305TN1	3.3	910
760203TN1	1.7	590	760306TN1	4.3	1070
760204TN1	2.3	700	760307TN1	4.8	1190
760205TN1	2.5	770	760307×3TN1	5.6	1290
760206TN1	2.9	890	760308TN1	5.6	1290
760207TN1	3.3	1020	760309TN1	7.0	1470
760208TN1	4.3	1180	760309×3TN1	7.6	1600
760209TN1	4.5	1240	760310TN1	7.6	1600
760210TN1	4.9	1360	760311TN1	8.8	1720
760211TN1	5.6	1390	760312TN1	10.0	1840
760212TN1	6.5	1620	760313TN1	12.0	2050
760213TN1	7.0	1750	760314TN1	12.0	2100
760214TN1	7.0	1750	760315TN1	14.5	2330
760215TN1	7.6	1880	760316TN1	16.0	2460
760216TN1	8.9	2040	760317TN1	17.5	2530
760217TN1	10.5	2200	760318TN1	18.0	2650
760218TN1	11.0	2270	760319TN1	19.0	2770
760219TN1	12.5	2430	760320TN1	21.5	2960
760220TN1	14.0	2590	760322TN1	29.3	3360
760222TN1	16.4	2800	760324TN1	31.3	3550
760224TN1	20.6	3130	760326TN1	33.7	3800
760226TN1	20.6	3280			

Tab. 56 Preload and axial rigidity of ball screw support bearings (Non-standard Metric, Inch series)

Bearing designation	Preload F_{a0}	Axial rigidity R_a	Bearing designation	Preload F_{a0}	Axial rigidity R_a
ZYS	KN	N/ μ m	ZYS	KN	N/ μ m
BS1547TN1	2.6	720	BSS2047TN1	2.3	700
BS1747TN1	2.6	720	BSS2362TN1	3.3	910
BS2047TN1	2.3	700	BSS3872TN1	2.9	1010
BS2562TN1	3.3	910	BSS4476TN1	3.1	1070
BS3062TN1	2.9	890	BSS5790TN1	3.6	1240
BS3072TN1	3.4	1040	BSS76110TN1	4.6	1530
BS3572TN1	3.3	1020	BSS101145TN1	7.5	2050
BS4072TN1	2.9	1010			
BS4090TN1	5.6	1290			
BS4575TN1	3.1	1070			
BS45100TN1	6.9	1470			
BS50100TN1	7.0	1470			
BS5590TN1	3.6	1240			
BS55100TN1	4.6	1390			
BS55120TN1	6.8	1550			
BS60120TN1	7.0	1620			
BS75110TN1	4.6	1530			
BS100150TN1	7.5	2050			

5 Lubrication

The main purpose of lubrication is to use the lubricants to form separating lubrication film on the rings, rolling elements and cages to reduce the friction and abrasion, prevent bearing being burnt and prolong bearing life. Moreover, the lubricants are used to avoid corrosion, decrease vibration and noise, cool down the bearing and protect bearing interior against contamination.

5.1 Grease lubrication

Grease lubrication is the most common lubrication method, because it is convenient to use and easy to maintain.

The most common grease in rolling bearings is lithium grease with mineral oil as base oil, and it has good adhesion lubrication in a wide range of temperature and speed. Application temperatures range for $-30^{\circ}\text{C}\sim +110^{\circ}\text{C}$. High-speed precision spindle bearings and ball screw support bearings can also use barium grease or calcium grease with synthetic double grease lubricating oil as base oil, and best viscosity is preferred as No. 2.

When ZYS high-speed precision bearings using grease lubrication, the grease quantity should take up about 15%~20% of bearing interior free space, Tab. 57 is about the grease quantity of spindle bearing, while the reference grease quantity of ball screw support bearings is shown in Tab. 58.

Running-in must be carried out in initial operation for grease-lubricated bearings. Excessive grease will be forced into the groove through running-in procedure to realize grease uniform distribution, and insure the minimum temperature of thermal equilibrium when bearing works normally.

The normal running-in procedure is to improve speed step by step, and one step can not be moved to next unless a stable bearing temperature has been reached. With more procedures or higher limiting speed, running-in will take much more time.

The running-in procedure should be carried out at 20% ~ 25% limiting speed in the begin, then increase the speed after the stable temperature is reached, finally the bearing limiting speed is realized with stable temperature. Monitoring the temperature at any time in running-in procedure. If possible, the temperature of outer ring should be monitored directly. If the temperature is over 60°C, stop running. When the temperature decreases to 10°C, we can restart with the same speed till the end of running-in procedure.

The lubrication grease should be added and replaced in time. When adding grease, pay attention that greases with different types and different specifications could not be mixed, otherwise, grease performance will decrease. In addition, the original grease should be cleaned off.

Tab. 57 Grease quantity of ZYS high-speed precision spindle bearings (reference value)

cm³

d mm	Spindle bearing series												
	718	719	70	72	H719	H70	HS719	HS70	B70	N10	NN30	2344, 2347	
8		0.08	0.15	0.25	0.08	0.15		0.15					
10	0.08	0.1	0.2	0.3	0.1	0.2	0.15	0.25	0.2				
12	0.08	0.1	0.2	0.4	0.2	0.2	0.18	0.28	0.2				
15	0.1	0.2	0.3	0.5	0.2	0.3	0.25	0.45	0.3				
17	0.1	0.2	0.4	0.7	0.3	0.4	0.30	0.55	0.4				
20	0.12	0.35	0.7	1.2	0.4	0.6	0.55	0.95	0.6				
25	0.15	0.35	0.9	1.4	0.4	0.8	0.65	1.1	0.8				
30	0.18	0.5	1.2	2.1	0.5	1.0	0.90	1.5	1.0	0.6	1.4	3.5	
35	0.2	0.7	1.6	2.9	0.8	1.3	1.1	2.2	1.3	0.8	1.6	4.5	
40	0.25	1.2	1.9	3.6	1.1	1.8	1.6	2.5	1.8	1.0	2.0	5.5	
45	0.28	1.3	2.5	4.4	1.2	2.2	2.1	3.5	2.2	1.2	2.6	7.0	
50	0.4	1.5	2.7	5.1	1.3	2.5	2.3	4.0	2.5	1.4	2.8	7.5	
55	0.8	1.8	3.7	6.7	1.5	3.3	3.2	5.5	3.3	2.0	4.0	11.0	
60	1.0	1.8	4.0	7.2	1.7	3.4	3.5	6.4	3.4	2.2	4.4	11.0	
65	1.2	2.2	4.5	8.4	1.7	3.8	3.8	6.5		2.3	4.6	12.0	
70	1.6	3.5	6.0	9.7	2.5	5.5	5.8	9.2		3.2	6.5	16.0	
75	2.0	3.8	6.2	10.5	2.8	6.0	6.1	9.5		3.5	7.0	17.0	
80	2.3	4.0	8.5	12.9	3.0	7.3	7.0	12.5		5.0	9.5	23.0	
85	2.7	6.0	8.7	16.0	4.0	7.8	8.5	13.4		5.0	10.0	25.0	
90	3.0	6.0	11.5	19.7	4.3	10.3	9.4	17.5		6.5	13.0	25.0	
95	3.5	6.0	12.0	23.9	4.4	10.8	9.8	18.4		6.5	13.0	35.0	
100	3.8	7.8	12.2	29.1	6.8	11.3	12.8	19.2		6.5	13.0	40.0	
105	4.2	8.2	15.5	34.3	7.0	13.5	13.3	24.5		9.0	18.0	55.0	
110	4.5	8.2	19.7	39.6	7.3	16.8	14.5	28.2		12.0	24.0	55.0	
120	5.8	12.5	20.5	46.8	9.0	18.0	17.8	30.3		13.0	27.0	60.0	
130	6.8	15.8	31.8	54.5	13.2	28.6	24.0	43.5		19.0	33.0	95.0	
140	7.9	16.8	33.6	69.4	14.0	30.4	25.6	46.3		21.0	36.0	105	
150	9.0	24.8	41.0	88.2	22.2	36.8	37.8	57.1		25.0	45.0	125	
160	10.1	26.4	50.7	111	23.2	45.6	39.8	69.5		30.0	55.0	155	
170	12.0	27.7	69.0	135	24.4	63.2				40.0	75.0	205	
180	14.0	41.0	92.1	141	37.0	84.0				53.0	100	285	
190	15.0	42.8	96.1	172	38.6	86.4				55.0	105	285	
200	19.0	60.2	120	208	56.5	114				73.0	135	370	
220	21.5	65.2	159	288	60.0	150				93.0	180	470	
240	27.5	70.7	170							100	200	560	
260	29.5	120								149	280	750	
280	38.0	127								161	310	765	
300	47.0											980	
320	50.0											1100	
340	53.0											1300	

Tab. 58 Grease quantity of ZYS ball screw support bearings (reference value)

Bearing designation ZYS	Reference grease quantity cm ³	Bearing designation ZYS	Reference grease quantity cm ³	Bearing designation ZYS	Reference grease quantity cm ³	Bearing designation ZYS	Reference grease quantity cm ³
760201TN1	0.4	760304TN1	1.9	BS1547TN1	2.0	BSS2047TN1	1.8
760202TN1	0.7	760305TN1	3.5	BS1747TN1	2.0	BSS2362TN1	2.6
760203TN1	0.9	760306TN1	5.0	BS2047TN1	1.8	BSS3872TN1	3.0
760204TN1	1.6	760307TN1	6.6	BS2562TN1	2.6	BSS4476TN1	3.4
760205TN1	2.2	760307X3TN1	9.2	BS3062TN1	2.6	BSS5790TN1	4.0
760206TN1	3.0	760308TN1	9.2	BS3072TN1	3.5	BSS76110TN1	5.5
760207TN1	4.0	760309TN1	12	BS3572TN1	3.1	BSS101145TN1	16
760208TN1	5.0	760309X3TN1	16	BS4072TN1	3.1		
760209TN1	6.0	760310TN1	16	BS4090TN1	6.8		
760210TN1	7.2	760311TN1	20	BS4575TN1	3.4		
760211TN1	8.7	760312TN1	24	BS45100TN1	7.0		
760212TN1	11	760313TN1	29	BS50100TN1	7.0		
760213TN1	13	760314TN1	34	BS5590TN1	4.2		
760214TN1	15	760315TN1	41	BS55100TN1	6.0		
760215TN1	17	760316TN1	49	BS55120TN1	8.2		
760216TN1	20	760317TN1	55	BS60120TN1	8.5		
760217TN1	25	760318TN1	65	BS75110TN1	8.5		
760218TN1	30	760319TN1	75				
760219TN1	36	760320TN1	88				
760220TN1	41	760322TN1	108				
760222TN1	58	760324TN1	148				
760224TN1	68	760326TN1	195				
760226TN1	73						

5.2 Oil Lubrication

Oil lubrication can be preferred when bearing works in high temperature and high speed.

The commonest oil lubrications for machine tool bearings are oil mist, oil-air, oil jet, etc. The advantages and disadvantage of the above lubrications are shown in Tab. 59.

Tab. 59 Performance comparison among the different kinds of oil lubrications

Lubrication	Advantages	Disadvantages
Oil mist lubrication	<ul style="list-style-type: none"> Oil deterioration would not occur due to the constant injection of new oil. Keep dust and cutting fluid outside. 	<ul style="list-style-type: none"> Oil mist contaminates environment. Oil flow is decided by the oil viscosity and temperature, so hard to control it to small flow. Hard to confirm actual oil supply.
Oil-air lubrication	<ul style="list-style-type: none"> Controllable optimum oil supply, low heat generation of bearing. Good cooling effect and low temperature rise. Keep dust and cutting fluid outside. Almost no contamination to environment. 	<ul style="list-style-type: none"> High cost of lubrication devices. Hard to determine the actual oil supply.
Oil jet lubrication	<ul style="list-style-type: none"> Keep dust and cutting fluid outside, and avoid burning down the bearing because of the large flow. Controllable temperature rise, because injecting oil takes heat away. 	<ul style="list-style-type: none"> High friction loss. Vertical mounting spindle is not preferred because of oil leakage. High cost of lubrication devices.

6 Fitting

The fitting between inner ring and shaft , outer ring and housing needs different requirements for positioning and fixation in radial, axial and circumferential (tangential) direction. The axial positioning can be realized through nuts, shoulder, end cap, spacer, elastic ring, the end of adjacent parts and so on. While the radial and circumferential positioning, in general, are completed through the fitting between inner ring and shaft , outer ring and housing.

For high-speed precision spindle bearings, to avoid excessive interference fit and rings deformation can reach good dimensional accuracy and running accuracy. On the other hand, for the high-speed bearings whose dmn is more than $1.0 \times 10^6 \text{ mm} \cdot \text{r/min}$. If the fitting between inner ring and shaft is not suitable, the inner ring will be expanded because of the centrifugal force when the bearing is running in high-speed. Then increase the clearance of shaft and inner ring and subsequently would be liding, friction and abrasion.

6.1 Dimensional tolerance of shaft and housing fitting with spindle bearings

In general application, the tolerance of fitting for spindle bearings as follows (from Tab. 60 to Tab. 67):

Tab. 60 refers to the recommended fits between the inner ring of angular contact ball bearings and shaft.

Tab. 60 Dimensional tolerance of fitting shaft for angular contact ball bearings(μm)

Shaft diameter mm		From	6	10	18	30	50	80	120	180	250
		up to	10	18	30	50	80	120	180	250	315
Accuracy class	P5	Upper deviation	0	0	0	0	0	+3	+4	+5	+6
		Lower deviation	-5	-5	-6	-7	-8	-7	-8	-9	-10
	P4 P4A P2	Upper deviation	0	0	0	0	0	+2	+3	+4	+5
		Lower deviation	-4	-4	-4	-5	-5	-4	-5	-6	-7
Magnitude of interference		Max.	2	2	2.5	2.5	3	4	4	5	6
		Min.	0	0	0	0	0	0	0	0	0

Tab. 61 refers to the recommended fits between the outer ring of angular contact ball bearings and housing.

Tab. 61 Dimensional tolerance of fitting housing for angular contact ball bearings(μm)

Housing diameter mm			From	10	18	30	50	80	120	180	250	315
			up to	18	30	50	80	120	180	250	315	400
Accuracy class	P5	Fixed end	Upper deviation	+8	+9	+11	+13	+13	+14	+16	+19	+21
			Lower deviation	0	0	0	0	-3	-4	-4	-4	-4
	Free end	Upper deviation	+10	+11	+13	+15	+15	+18	+20	+23	+25	
		Lower deviation	+2	+2	+2	+2	0	0	0	0	0	
	P4 P4A P2	Fixed end	Upper deviation	+5	+6	+7	+8	+8	+9	+11	+13	+15
			Lower deviation	0	0	0	0	-3	-3	-3	-3	-3
Free end	Upper deviation	+7	+8	+9	+10	+10	+12	+14	+16	+18		
	Lower deviation	+2	+2	+2	+2	0	0	0	0	0		
Magnitude of clearance		Fixed end	Max.	—	6	6	6	8	8	10	11	15
			Min.	—	2	2	2	3	3	5	5	6
		Free end	Max.	—	11	11	11	15	15	20	23	28
			Min.	—	6	6	6	9	9	13	15	18

Tab. 62 refers to the recommended fitting between cylindrical roller bearings (cylindrical bore) and shaft

Tab. 62 Dimensional tolerance of fitting shaft for cylindrical roller bearings (cylindrical bore)

Shaft diameter mm		From	18	30	50	80	120	180	250	315
		up to	30	50	80	120	180	250	315	400
Accuracy class	S P	Upper deviation	+3	+3.5	+4	+5	+6	+7	+8	+9
		Lower deviation	-3	-3.5	-4	-5	-6	-7	-8	-9
	U P	Upper deviation	+2	+2	+2.5	+3	+4	+5	+6	+6.5
		Lower deviation	-2	-2	-2.5	-3	-4	-5	-6	-6.5
Magnitude of interference		Max.	2.5	2.5	3	4	4	5	6	7
		Min.	0	0	0	0	0	0	0	0

For the cylindrical roller bearings with tapered bore, if the shaft taper is not consist with the tapered bore, the radial clearances of rollers' two ends (or the interferences) are different after bearing mounted, which will cause non-uniform distribution of loading, decreased rigidity and unstable working, then influence bearing performance and service life. Therefore, the contact area ratio between shaft taper and tapered bore of inner ring should be up to more than 80%.

Tab. 63 refers to the recommended fitting between cylindrical roller bearings (tapered bore) and shaft. The upper deviation and lower deviation of shaft only refer to the small end of tapered shaft.

Tab. 63 Dimensional tolerance of fitting shaft for cylindrical roller bearings (tapered bore)

Shaft diameter mm		From	18	30	40	50	65	80	100	120	140	160	180	200	225	250
		up to	30	40	50	65	80	100	120	140	160	180	200	225	250	280
The deviation of small end of tapered shaft	Upper deviation	+73	+91	+108	+135	+159	+193	+225	+266	+298	+328	+370	+405	+445	+498	
	Lower deviation	+64	+80	+97	+122	+146	+178	+210	+248	+280	+310	+350	+385	+425	+475	

Tab. 64 refers to the recommended fitting between the outer ring of cylindrical roller bearings and housing.

Tab. 64 Dimensional tolerance of fitting housing for cylindrical roller bearings

Housing diameter mm		From	30	50	80	120	180	250	315	400
		up to	50	80	120	180	250	315	400	500
Accuracy class	S P	Upper deviation	+2	+3	+2	+3	+2	+3	+3	+2
		Lower deviation	-9	-10	-13	-15	-18	-20	-22	-25
	U P	Upper deviation	+1	+1	+1	+1	0	0	0	0
		Lower deviation	-6	-7	-9	-11	-14	-16	-17	-20
Magnitude of clearance (or interference)		Max.(clearance)	2	2	2	2	2	3	3	3
		Min.(interference)	2	2	2	2	2	3	3	3

Tab. 65 refers to the recommended shaft fitting for double-direction angular contact thrust ball bearings and high-speed angular contact thrust ball bearings.

Tab. 65 Dimensional tolerance of fitting shaft for double-direction angular contact thrust ball bearings and high-speed angular contact thrust ball bearings

μm

Shaft diameter mm		From	18	30	50	80	120	180	250	315
		up to	30	50	80	120	180	250	315	400
Accuracy class	S P	Upper deviation	0	0	0	0	0	0	0	0
		Lower deviation	-6	-7	-8	-10	-12	-14	-16	-18
	U P	Upper deviation	0	0	0	0	0	0	0	0
		Lower deviation	-4	-4	-5	-6	-8	-10	-12	-13
Magnitude of interference		Max.	2.5	2.5	3	4	4	5	6	7
		Min.	0	0	0	0	0	0	0	0

Since the double-direction angular contact thrust ball bearings and high-speed angular contact thrust ball bearings are matched with cylindrical roller bearings, the fitting between outer ring and housing is the same as that of cylindrical roller bearings.

Tab. 66 refers to the recommended fitting between tapered roller bearings and shaft.

Tab. 66 Dimensional tolerance of fitting shaft for tapered roller bearings

μm

Shaft diameter mm		From	18	30	50	80	120	180	250
		up to	30	50	80	120	180	250	315
Accuracy class	P5	Upper deviation	+11	+13	+15	+18	+21	+24	+27
		Lower deviation	+2	+2	+2	+3	+3	+4	+4
	P4	Upper deviation	+11	+13	+15	+18	+21	+24	+27
		Lower deviation	+2	+2	+2	+3	+3	+4	+4

Tab. 67 refers to the recommended fitting between tapered roller bearings and housing.

Tab. 67 Dimensional tolerance of fitting housing for tapered roller bearings

 μm

Housing diameter mm			From	30	50	80	120	180	250
			up to	50	80	120	180	250	315
Accuracy class	P 5	No axial adjustment of outer ring mounted into housing	Upper deviation	-13	-15	-18	-21	-21	-25
			Lower deviation	-24	-28	-33	-39	-39	-45
		Free end	Upper deviation	+20	+23	+27	+32	+32	+35
			Lower deviation	+9	+10	+12	+14	+14	+15
		Axial adjustment of outer ring mounted into housing	Upper deviation	+2	+3	+2	+3	+3	+2
			Lower deviation	-9	-10	-13	-15	-15	-18
	P 4	No axial adjustment of outer ring mounted into housing	Upper deviation	-5	-6	-8	-9	-9	-11
			Lower deviation	-16	-19	-23	-27	-27	-31
		Free end	Upper deviation	+20	+23	+27	+32	+32	+35
			Lower deviation	+9	+10	+12	+14	+14	+15
		Axial adjustment of outer ring mounted into housing	Upper deviation	+2	+3	+2	+3	+3	+2
			Lower deviation	-9	-10	-13	-15	-15	-18

6.2 The geometric tolerances of fitting shaft and housing for spindle bearings

High requirements for the dimensional accuracy and geometric tolerances of shaft and housing relative to the fitting bearings can achieve high running accuracy, high speed and low temperature rise of spindle.

Tab. 68 Limit of tolerance Class

 μm

Nominal diameter mm	From	6	10	18	30	50	80	120	180	250	315
	up to	10	18	30	50	80	120	180	250	315	400
Tolerance class	IT1	1	1.2	1.5	1.5	2	2.5	3.5	4.5	6	7
	IT2	1.5	2	2.5	2.5	3	4	5	7	8	9
	IT3	2.5	3	4	4	5	6	8	10	12	13
	IT4	4	5	6	7	8	10	12	14	16	18

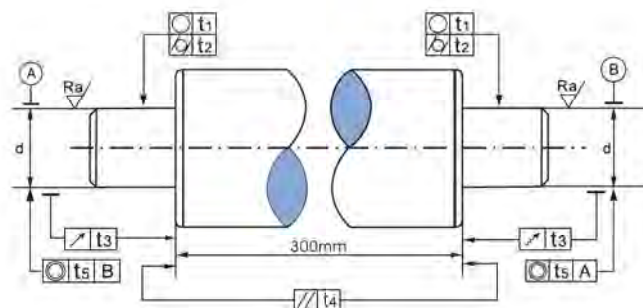

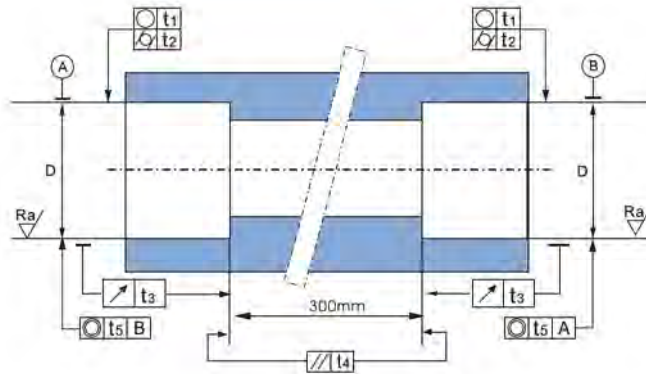

Fig. 15 Fitting shaft and fitting housing

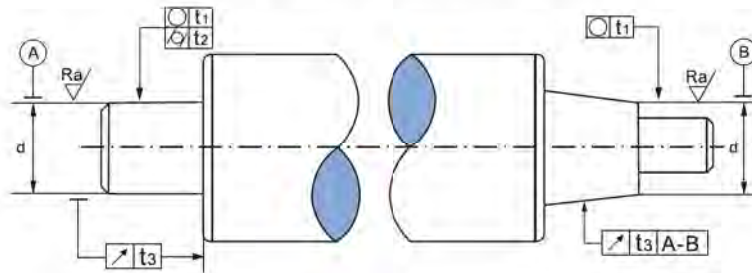

Fig. 16 Fitting tapered shaft

Tab. 69 Tolerances of fitting shaft

Symbols of tolerance		Bearing precision		
		P5	P4	P4A, P2
○	Circularity/roundness t ₁	$\frac{IT3}{2}$	$\frac{IT2}{2}$	$\frac{IT1}{2}$
⊘	Cylindricity t ₂	$\frac{IT3}{2}$	$\frac{IT2}{2}$	$\frac{IT1}{2}$
/	Runout t ₃	IT3	IT2	IT1
//	Parallelism t ₄	IT3	IT2	IT1
◎	Coaxiality t ₅	IT4	IT3	IT2
Ra	Roughness (μm)	0.4	0.4	0.2

Tab. 70 Tolerances of fitting housing

Symbols of tolerance		Bearing precision		
		P5	P4	P4A, P2
○	Circularity/roundness t ₁	$\frac{IT3}{2}$	$\frac{IT2}{2}$	$\frac{IT1}{2}$
⊘	Cylindricity t ₂	$\frac{IT3}{2}$	$\frac{IT2}{2}$	$\frac{IT1}{2}$
/	Runout t ₃	IT3	IT2	IT1
//	Parallelism t ₄	IT3	IT2	IT1
◎	Coaxiality t ₅	IT4	IT3	IT2
Ra	Roughness (μm)	0.8	0.4	0.4

6.3 Tolerances of fitting parts for ball screw support bearings

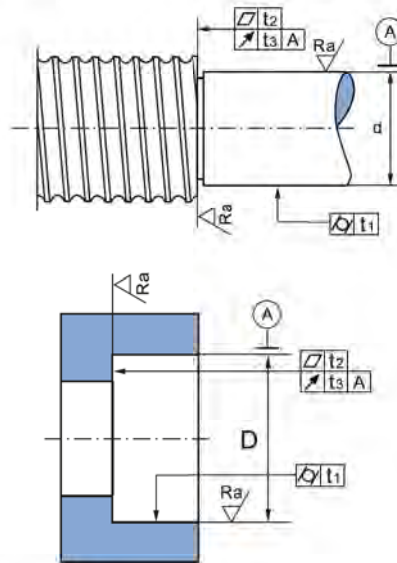

Fig. 17 Fitting parts for ball screw support bearings

The recommended accuracys of fitting parts for ball screw support bearings in Tab. 71 and 72.

Tab. 71 Tolerances of fitting shaft for ball screw support bearings

		μm							
Shaft diameter d(mm)	From	10	18	30	50	80	120	180	250
	Up to	18	30	50	80	120	180	250	315
Tolerance	Upper deviation	0	0	0	0	0	0	0	0
	Lower deviation	-8	-9	-11	-13	-15	-18	-20	-23
Cylindricity	t_1	2	2.5	2.5	3	4	5	7	8
Flatness	t_2	1.2	1.5	1.5	2	2.5	3.5	4.5	6
End face runout	t_3	2	2.5	2.5	3	4	5	7	8
Roughness on surface	R_a	0.4	0.4	0.4	0.4	0.4	0.4	0.8	0.8

Tab. 72 Tolerances of fitting housing for ball screw support bearings

		μm							
Housing diameter d(mm)	From	18	30	50	80	120	180	250	315
	Up to	30	50	80	120	180	250	315	400
Tolerance	Upper deviation	+8	+10	+13	+16	+18	+22	+25	+29
	Lower deviation	-5	-6	-6	-6	-7	-7	-7	-7
Cylindricity	t_1	2.5	2.5	3	4	5	7	8	9
Flatness	t_2	2.5	2.5	3	4	5	7	8	9
End face runout	t_3	4	4	5	6	8	10	12	13
Roughness on surface	R_a	0.8	0.8	0.8	0.8	0.8	0.8	1.6	1.6

7 Matched bearing sets

To increase the load capacity and rigidity, the angular contact ball bearings for machine tool spindle are usually matched in pairs or set of more units.

Every single bearing to be matched should meet the requirements of boundary dimension tolerances and running accuracy, besides, there are high requirements for the following performance parameters between any two bearings:

- (1) Mean bore diameter difference between any two bearings.
- (2) The radial runout difference of inner rings between any two bearings.
- (3) Mean outside diameter difference between any two bearings.
- (4) The radial runout difference of outer rings between any two bearings.
- (5) Actual contact angle difference between any two bearings.
- (6) The protrusion difference between any two adjacent bearings.

7.1 Duplex arrangement

Duplex arrangement bearings have three kinds of configuration, back-to-back (DB), face-to-face (DF) and tandem (DT), their structures and features are shown as follows:

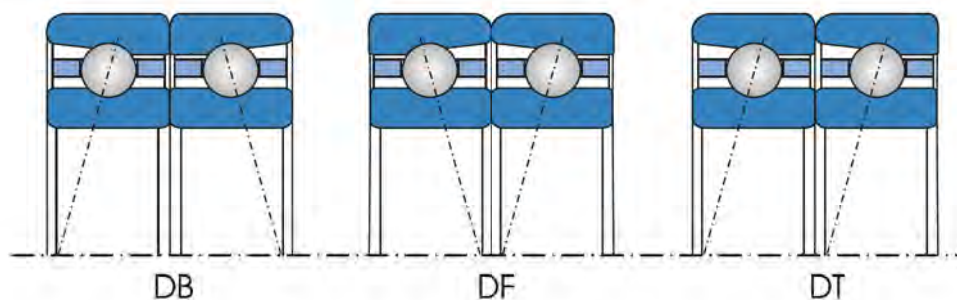

Fig. 18 Structures of duplex configuration bearings

Tab. 73 Features of duplex configuration bearings

Paired configuration	Code	Features
Back-to-Back	DB	<ul style="list-style-type: none"> • Symmetrical arrangement; • Supporting radial load; • Supporting axial loads in two directions; • Supporting high overturning moment.
Face-to-Face	DF	<ul style="list-style-type: none"> • Symmetrical arrangement; • Supporting radial load; • Supporting axial loads in two directions; • slight self-aligning with poor support overturning moment Ability.
Tandem	DT	<ul style="list-style-type: none"> • Two bearings are identical • Arranged in same direction; • Supporting radial load; • Supporting larger axial load in one direction.

7.2 Multiple arrangement

To obtain higher loading capacity and rigidity, the angular contact ball bearings for machine tool spindles are in sets with three, four and even five bearings. Among them, the drawings below show a few examples of multiple arrangements.

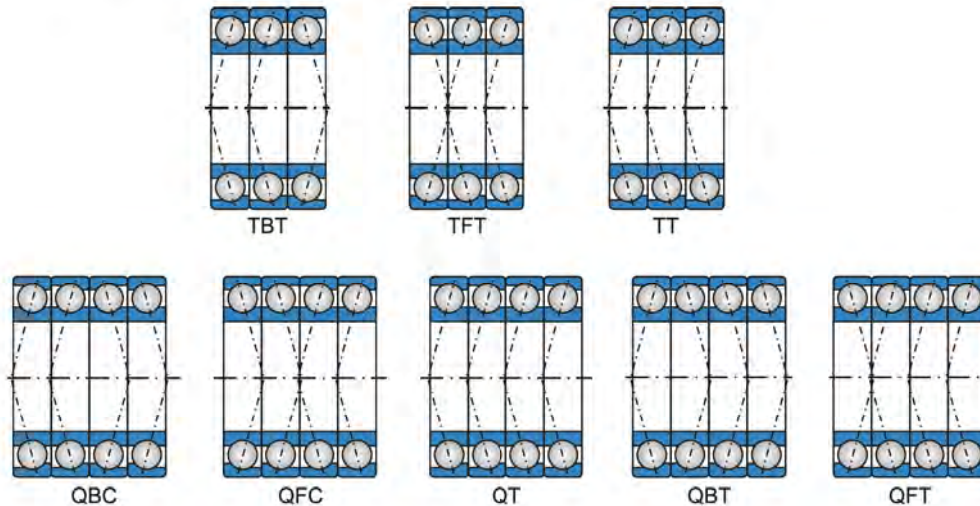

Fig. 19 Multiple arrangement bearings

As for matched bearings, bearing sets performance changes with the direction of loading. Therefore, there is a constant mounting direction for bearing arrangements, especially for bearings with asymmetrical arrangement. As a result, we mark "V" on outer diameter surface in axial direction. Moreover, the opening mouth of "V" points to the the axial load acted on inner ring, that is to say, the direction of "V" closed angle should be identical with the direction of the axial load acted on inner ring. If the loads acted on inner ring are double direction, the direction of "V" closed angle should be identical with the direction of larger axial load acted on inner ring.

7.3 Universal Bearings

Except for the above constant direction configurations, we also support universal matching bearings, that is, in pair can be arranged in any required arrangement DB, DF or Tandem. The end faces protrusion values of single universal bearings are identical.

The usual offered preloads of universal matching bearings are also Light (A), Medium (B), High (C) and special preload.

8 Allowable operating temperature

The operating temperature of ZYS precision rolling bearings depends on bearing material, preload, operating load, speed, lubrication, cooling, and ambient temperature. In general, the higher the load and speed, the higher the operating temperature of grease lubrication bearings.

ZYS precision rolling bearings rings can usually withstand temperature 150°C; while the phenolic resin cages can withstand the maximum temperature 120°C. Other bearings with copper or aluminium alloy cages can withstand the maximum temperature 150°C.

Without artificial cooling and external heat, the inner ring temperature is always higher than outer ring temperature. The temperature of rolling elements is higher than that of inner ring.

Overheating can change bearing internal state. For precision angular contact ball bearings in high speed, the temperature difference between inner ring and outer ring will cause the larger actual preload than assembly preload, and lead to premature abrasion, bearing stuck and even worse situation. Therefore, bearing operating temperature must be controlled.

According to the lubrication methods and cooling situation, the allowable operating temperature of oil mist and oil-air lubrication bearings is much higher than that of grease lubrication bearings.

If higher temperature bearings are requested, please contact with us.

9 Bearing mounting dimensions

To ensure bearing end faces contact with shoulder and to avoid transition fillet collide with bearing chamfer, the one-way maximum fillet radius of shaft and housing should comply with the values in Tab. 74 and 78.

The shoulder height not only contact with bearing end faces, but also should be convenient for using mounting and dismounting tools. In general, the minimum height of shoulder should correspond to the values in Tab. 74 and 78.

Tab. 74 Angular contact ball bearings mounting dimensions (mm)

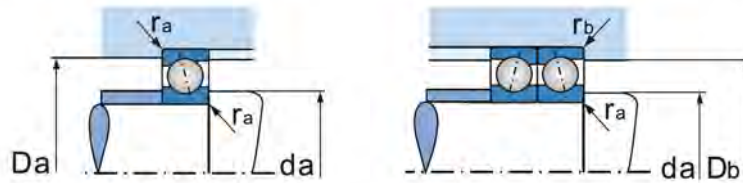

d mm	Bearing series															
	718				719				70				72			
	d _a min	D _a /D _b max	r _a max	r _b max	d _a min	D _a /D _b max	r _a max	r _b max	d _a min	D _a /D _b max	r _a max	r _b max	d _a min	D _a /D _b max	r _a max	r _b max
8					10.5	17.0	0.3	0.1	11.0	19.0	0.3	0.15	11.0	21.0	0.3	0.15
10	12.0	17.0	0.3	0.1	12.5	19.5	0.3	0.1	13.5	22.5	0.3	0.15	14.5	25.5	0.6	0.15
12	14.0	19.0	0.3	0.1	14.5	21.5	0.3	0.1	15.0	25.0	0.3	0.15	16.5	27.5	0.6	0.15
15	17.0	22.0	0.3	0.1	17.5	25.5	0.3	0.1	19.0	28.5	0.3	0.15	18.5	31.5	0.6	0.15
17	19.0	24.0	0.3	0.1	19.5	27.5	0.3	0.1	20.5	31.5	0.3	0.15	21.5	35.5	0.6	0.3
20	23.0	29.0	0.3	0.1	23.0	33.5	0.3	0.15	24.5	37.5	0.6	0.15	26.5	40.5	1.0	0.3
25	28.0	34.0	0.3	0.15	29.0	38.5	0.3	0.15	29.0	43.5	0.6	0.15	30.5	46.5	1.0	0.3
30	33.0	39.0	0.3	0.15	34.0	43.5	0.3	0.15	34.5	50.5	1.0	0.3	36.5	55.5	1.0	0.3
35	38.0	44.0	0.3	0.15	39.5	50.5	0.6	0.15	40.5	56.5	1.0	0.3	44.0	63.0	1.1	0.6
40	43.0	49.0	0.3	0.15	44.5	57.5	0.6	0.15	46.0	62.0	1.0	0.3	49.0	71.0	1.1	0.6
45	48.5	54.5	0.3	0.15	50.0	63.0	0.6	0.15	50.5	69.5	1.0	0.3	54.0	76.0	1.1	0.6
50	53.5	61.5	0.3	0.15	54.0	68.0	0.6	0.15	55.5	74.5	1.0	0.3	57.5	83.0	1.1	0.6
55	58.5	68.5	0.3	0.15	59.5	75.5	1.0	0.3	61.5	83.5	1.1	0.6	63.0	92.0	1.5	0.6
60	63.5	74.5	0.3	0.15	64.5	80.5	1.0	0.3	66.5	88.5	1.1	0.6	71.5	100.5	1.5	0.6
65	69.5	80.5	0.6	0.15	70.5	85.5	1.0	0.3	71.5	93.5	1.1	0.6	76.5	108.5	1.5	0.6
70	74.5	85.5	0.6	0.15	75.5	94.5	1.0	0.3	77.5	103.0	1.1	0.6	81.5	113.5	1.5	0.6
75	79.5	90.5	0.6	0.15	80.5	99.5	1.0	0.3	82.5	108.0	1.1	0.6	86.5	118.5	1.5	0.6
80	84.5	95.5	0.6	0.15	85.5	104.5	1.0	0.3	88.0	117.0	1.1	0.6	92.5	128.0	2.0	1.0
85	90.5	104.5	1.0	0.3	91.5	113.5	1.1	0.6	93.0	122.0	1.1	0.6	98.5	137.0	2.0	1.0
90	95.5	109.5	1.0	0.3	96.5	118.5	1.1	0.6	100.5	130.0	1.5	0.6	103.0	147.0	2.0	1.0
95	100.5	114.5	1.0	0.3	101.5	123.5	1.1	0.6	104.0	136.0	1.5	0.6	112.0	153.0	2.1	1.1
100	105.5	119.5	1.0	0.3	107.5	133.0	1.1	0.6	109.5	141.0	1.5	0.6	116.0	164.0	2.1	1.1
105	110.5	124.5	1.0	0.3	112.5	138.0	1.1	0.6	115.0	150.0	2.0	1.0	122.0	173.0	2.1	1.1
110	116.5	134.0	1.0	0.3	117.5	143.0	1.1	0.6	121.0	159.0	2.0	1.0	130.0	181.0	2.1	1.1
120	126.5	144.0	1.0	0.3	128.5	157.0	1.1	0.6	131.0	169.0	2.0	1.0	143.0	192.0	2.1	1.1
130	138.0	157.5	1.1	0.6	140.5	169.5	1.5	0.6	142.5	187.5	2.0	1.0	151.5	209.0	3.0	1.1
140	147.5	168.0	1.1	0.6	150.5	179.5	1.5	0.6	152.5	197.5	2.0	1.0	165.0	225.5	3.0	1.1
150	159.0	181.5	1.1	0.6	161.0	199.5	2.0	1.0	163.5	211.5	2.1	1.1	178.5	242.0	3.0	1.1
160	169.0	191.0	1.1	0.6	171.0	209.5	2.0	1.0	174.5	225.5	2.1	1.1	193.5	257.0	3.0	1.1
170	180.0	205.5	1.1	0.6	181.0	219.5	2.0	1.0	188.0	242.0	2.1	1.1	202.0	278.5	4.0	1.5
180	190.0	215.0	1.1	0.6	192.5	237.5	2.0	1.0	201.5	259.0	2.1	1.1	212.0	288.5	4.0	1.5
190	202.0	228.0	1.5	0.6	202.5	247.5	2.0	1.0	211.5	269.0	2.1	1.1	227.0	303.5	4.0	1.5
200	212.0	238.0	1.5	0.6	214.5	265.5	2.0	1.0	220.0	290.0	2.1	1.1	242.0	318.5	4.0	1.5
220	232.0	258.0	1.5	0.6	234.5	285.5	2.0	1.0	242.0	318.5	3.0	1.1	265.0	355.0	4.0	1.5
240	254.0	286.0	2.0	1.0	254.5	305.5	2.1	1.0	262.0	338.5	3.0	1.1				
260	274.0	306.0	2.0	1.1	278.5	342.0	2.1	1.0								
280	296.0	328.0	2.0	1.1	298.5	362.0	2.1	1.0								

Continued Tab. 74 Angular contact ball bearings mounting dimensions (mm)

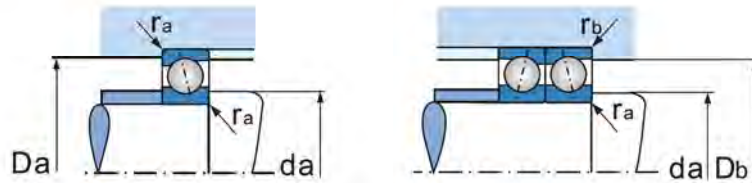

d mm	Bearing series											
	H719, H719/HQ1 H719-DL, H719-DL/HQ1				H70, H70/HQ1 H70-DL, H70-DL/HQ1				B70 C, B70 C/HQ1			
	d_o min	D_o/D_b max	r_a max	r_b max	d_o min	D_o/D_b max	r_a max	r_b max	d_o min	D_o/D_b max	r_a max	r_b max
8	10.5	16.5	0.3	0.1	11.0	19.0	0.3	0.15				
10	13.0	19.0	0.3	0.1	13.5	22.5	0.3	0.15	12.0	23.0	0.3	0.15
12	15.0	21.0	0.3	0.1	15.5	25.0	0.3	0.15	14.0	25.0	0.3	0.15
15	17.5	25.5	0.3	0.1	19.0	28.5	0.3	0.15	17.5	29.0	0.3	0.15
17	19.5	27.5	0.3	0.1	20.5	31.5	0.3	0.15	19.5	31.0	0.3	0.15
20	24.0	33.5	0.3	0.15	24.5	37.5	0.6	0.15	22.5	37.0	0.6	0.15
25	29.0	38.5	0.3	0.15	29.5	42.0	0.6	0.15	27.5	42.0	0.6	0.15
30	34.0	43.5	0.3	0.15	36.5	48.5	1.0	0.3	33.5	49.0	1.0	0.3
35	39.5	50.5	0.6	0.15	41.5	55.5	1.0	0.3	38.0	55.0	1.0	0.3
40	44.5	57.5	0.6	0.15	47.0	61.0	1.0	0.3	43.0	61.0	1.0	0.3
45	50.0	63.0	0.6	0.15	53.0	67.0	1.0	0.3	48.5	68.0	1.0	0.3
50	54.0	68.0	0.6	0.15	57.5	72.5	1.0	0.3	53.5	73.5	1.0	0.3
55	59.5	75.5	1.0	0.3	64.5	80.5	1.1	0.6	59.5	83.0	1.1	0.6
60	64.5	80.5	1.0	0.3	69.5	85.5	1.1	0.6	65.0	88.0	1.1	0.6
65	69.5	85.5	1.0	0.3	74.0	91.0	1.1	0.6				
70	75.5	94.5	1.0	0.3	80.5	99.5	1.1	0.6				
75	80.5	99.5	1.0	0.3	85.5	104.5	1.1	0.6				
80	85.5	104.5	1.0	0.3	91.5	113.5	1.1	0.6				
85	91.5	113.5	1.1	0.6	96.5	118.5	1.1	0.6				
90	96.5	118.5	1.1	0.6	104.5	126.0	1.5	6.0				
95	101.5	123.5	1.1	0.6	107.5	132.5	1.5	0.6				
100	107.5	133.0	1.1	0.6	112.5	137.5	1.5	0.6				
105	112.5	138.0	1.1	0.6	119.5	145.5	2.0	1.0				
110	117.0	143.0	1.1	0.6	127.5	152.5	2.0	1.0				
120	127.0	156.0	1.1	0.6	135.5	164.5	2.0	1.0				
130	140.5	169.5	1.5	0.6	150.5	179.5	2.0	1.0				
140	150.5	179.5	1.5	0.6	160.5	189.5	2.0	1.0				
150	164.0	196.0	2.0	1.0	171.5	203.5	2.1	1.1				
160	174.0	206.0	2.0	1.0	184.0	216.0	2.1	1.1				
170	184.0	216.0	2.0	1.0	199.0	231.0	2.1	1.1				
180	197.5	232.5	2.0	1.0	214.0	246.0	2.1	1.1				
190	207.5	242.5	2.0	1.0	222.5	257.5	2.1	1.1				
200	222.5	257.5	2.0	1.0	237.5	272.5	2.1	1.1				
220	241.0	279.5	2.0	1.0	261.0	299.5	3.0	1.1				

Continued Tab. 74 Angular contact ball bearings mounting dimensions (mm)

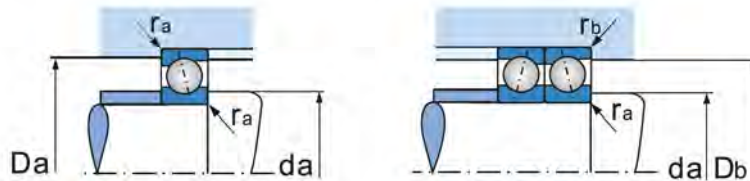

d mm	Bearing series							
	HS719, HS719/HQ1 B719-2RZ, B719-2RZ/HQ1				HS70, HS70/HQ1 B70-2RZ, B70-2RZ/HQ1			
	d_a min	D_a/D_b max	r_a max	r_b max	d_a min	D_a/D_b max	r_a max	r_b max
10	12.0	19.5	0.3	0.1	12.5	23.5	0.3	0.15
12	14.0	21.5	0.3	0.1	14.5	25.5	0.3	0.15
15	17.0	25.5	0.3	0.1	17.5	29.0	0.3	0.15
17	19.0	27.5	0.3	0.1	20.0	32.0	0.3	0.15
20	22.0	33.5	0.3	0.15	25.0	37.0	0.6	0.15
25	27.0	38.5	0.3	0.15	30.0	42.0	0.6	0.15
30	32.0	43.5	0.3	0.15	36.0	49.0	1.0	0.3
35	40.0	50.5	0.6	0.15	41.0	56.0	1.0	0.3
40	45.0	57.5	0.6	0.15	46.0	62.0	1.0	0.3
45	50.0	63.5	0.6	0.15	51.0	69.0	1.0	0.3
50	55.0	67.5	0.6	0.15	56.0	74.0	1.0	0.3
55	60.0	75.5	1.0	0.3	62.0	83.0	1.1	0.6
60	65.0	80.5	1.0	0.3	67.0	88.0	1.1	0.6
65	70.0	85.5	1.0	0.3	72.5	93.0	1.1	0.6
70	76.0	94.5	1.0	0.3	77.0	102.5	1.1	0.6
75	81.0	99.5	1.0	0.3	82.0	107.0	1.1	0.6
80	86.0	104.0	1.0	0.3	88.0	117.0	1.1	0.6
85	92.0	114.0	1.1	0.6	93.0	122.0	1.1	0.6
90	97.0	119.0	1.1	0.6	100.0	131.0	1.5	0.6
95	102.0	124.0	1.1	0.6	105.0	136.0	1.5	0.6
100	107.0	133.0	1.1	0.6	110.0	141.0	1.5	0.6
105	112.0	138.0	1.1	0.6	116.0	150.0	2.0	1.0
110	117.0	143.0	1.1	0.6	121.0	159.0	2.0	1.0
120	128.0	157.0	1.1	0.6	131.0	169.0	2.0	1.0
130	139.0	171.0	1.5	0.6	142.0	189.0	2.0	1.0
140	149.0	181.0	1.5	0.6	152.0	199.0	2.0	1.0
150	160.0	199.0	2.0	1.0	163.0	213.0	2.1	1.1
160	170.0	209.0	2.0	1.0	174.0	228.0	2.1	1.1
170	180.0	219.0	2.0	1.0	185.0	246.0	2.1	1.1
180	192.0	238.0	2.0	1.0	196.0	264.0	2.1	1.1
190	202.0	247.0	2.0	1.0	206.0	274.0	2.1	1.1
200	214.0	266.0	2.0	1.0	217.0	293.0	2.1	1.1
220	234.0	286.0	2.0	1.0	239.0	321.0	3.0	1.1

Tab. 75 Cylindrical roller bearings mounting dimensions (mm)

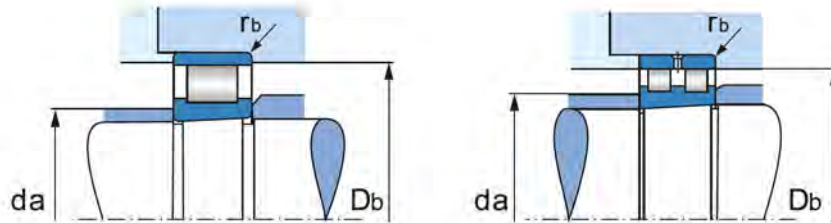

d mm	Bearing series						
	N10K			NN30K/W33			
	d _o min	D _b max	r _b max	d _a min	D _b min	D _b max	R _b max
30	33.5	49	0.6	35	49	50	1.0
35	38.5	56	0.6	40	56	57	1.0
40	43.5	62	0.6	45	62	63	1.0
45	48.5	69	0.6	50	69	70	1.0
50	53.5	74	0.6	55	74	75	1.0
55	61.0	82	1.0	61	82	84	1.0
60	66.0	87	1.0	66	87	89	1.0
65	71.0	92	1.0	71	92	94	1.0
70	76.0	102	1.0	76	102	104	1.0
75	81.0	107	1.0	81	107	109	1.0
80	86.0	115	1.0	86	115	119	1.0
85	91.0	120	1.0	91	120	124	1.0
90	97.0	129	1.0	97	129	133	1.5
95	102.0	134	1.0	102	134	138	1.5
100	107.0	139	1.0	107	139	143	1.5
105	114.0	148	1.0	114	148	151	2.0
110	118.0	157	1.1	119	157	161	2.0
120	129.0	167	1.0	129	167	171	2.0
130	139.0	184	1.0	139	184	191	2.0
140	149.0	194	1.0	149	194	201	2.0
150	160.5	208	1.5	160	208	215	2.1
160	170.5	222	1.5	170	222	230	2.1
170	180.5	239	2.1	180	239	250	2.1
180	190.5	258	2.1	190	258	270	2.1
190	200.5	268	2.1	200	268	280	2.1
200	210.5	285	2.1	210	285	300	2.1
220	232.5	313	2.5	232	313	328	2.5
240	252.5	334	2.5	252	334	348	2.5
260	275.0	368	3.0	275	368	385	3.0
280	295.0	388	3.0	295	388	405	3.0

Tab. 76 Double-direction angular contact thrust ball bearings mounting dimensions (mm)

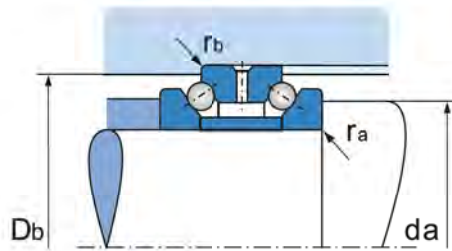

Bearing series		da	Db	ra	rb
2344	2347				
d(mm)		min	min	max	max
30	32	40.5	50.5	1.0	0.15
35	37	46.5	57.0	1.0	0.15
40	42	51.5	63.5	1.0	0.15
45	47	57.5	70.0	1.0	0.15
50	52	62.5	75.0	1.0	0.15
55	57	69.0	84.5	1.0	0.3
60	62	74.0	89.5	1.0	0.3
65	67	79.0	94.5	1.0	0.3
70	73	86.5	103.5	1.0	0.3
75	78	91.5	108.5	1.0	0.3
80	83	98.5	117.0	1.0	0.3
85	88	103.5	122.0	1.0	0.3
90	93	110.5	130.5	1.5	0.3
95	98	115.5	135.5	1.5	0.3
100	103	120.5	140.5	1.5	0.3
105	109	128.0	150.0	2.0	0.6
110	114	134.5	160.0	2.0	0.6
120	124	144.5	170.0	2.0	0.6
130	135	159.0	188.0	2.0	0.6
140	145	169.0	198.0	2.1	0.6
150	155	181.0	211.5	2.1	0.6
160	165	192.5	226.0	2.1	0.6
170	176	206.5	245.0	2.1	0.6
180	187	221.0	263.0	2.1	0.6
190	197	231.0	273.0	2.1	0.6
200	207	245.0	291.5	2.1	0.6
220	228	269.0	318.0	2.5	1.0
240	248	289.0	338.0	2.5	1.0
260	269	317.5	374.5	3.0	1.5
280	289	337.5	394.5	3.0	1.5
300	310	366.0	428.5	3.0	1.5
320	330	386.0	448.5	3.0	1.5
340	350	413.0	485.5	3.0	1.5

Tab. 77 High-speed angular contact thrust ball bearings mounting dimensions (mm)

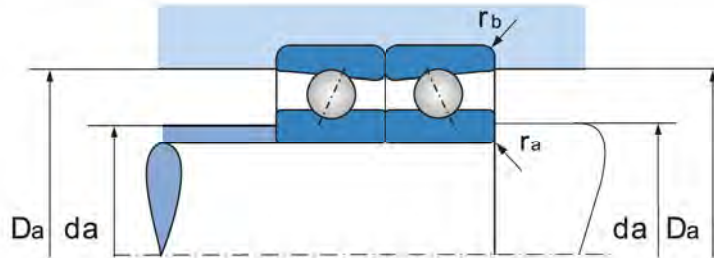

d mm	d_a	D_b	r_a	r_b
	min		max	
50	61	75	1.0	0.5
55	68	84	1.0	0.6
60	73	89	1.0	0.6
65	78	94	1.0	0.6
70	85	104	1.0	0.6
75	90	110	1.0	0.6
80	97	117	1.0	0.6
85	102	122	1.0	0.6
90	109	132	1.5	0.8
95	114	137	1.5	0.8
100	119	142	1.5	0.8
105	125	151	2.0	1.0
110	132	159	2.0	1.0
120	142	169	2.0	1.0
130	156	188	2.0	1.0
140	166	198	2.0	1.0
150	178	213	2.0	1.0
160	190	228	2.0	1.0
170	204	245	2.0	1.0
180	216	264	2.0	1.0
190	226	274	2.0	1.0
200	240	291	2.0	1.0

Tab. 78 Tapered roller bearings mounting dimensions (mm)

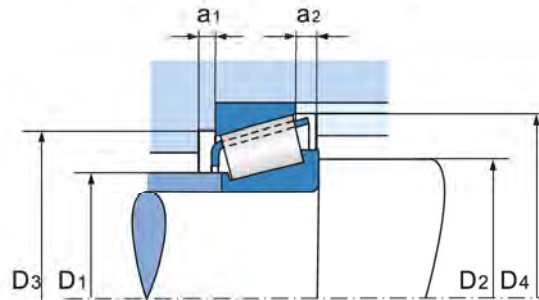

d mm	D ₁	D ₂	D ₃	D ₃	D ₄	a ₁	a ₂
	max	min		max	min		
20	25	25	36	37	39	3	3
25	30	30	40	42	44	3	3
30	35	36	48	49	52	3	4
35	40	41	54	56	59	4	4
40	46	46	60	62	65	4	4.5
45	51	51	67	69	72	4	4.5
50	56	56	72	74	77	4	4.5
55	63	62	81	83	86	4	5.5
60	67	67	85	88	91	4	5.5
65	72	72	90	93	97	4	5.5
70	78	77	98	103	105	5	6
75	83	82	103	108	110	5	6
80	89	87	112	117	120	6	7
85	94	92	117	122	125	6	7
90	100	99	125	131	134	6	8
95	105	104	130	136	140	6	8
100	109	109	134	141	144	6	8
105	116	115	143	150	154	6	9
110	122	120	152	160	163	7	9
120	131	130	161	170	173	7	9
130	144	140	178	190	192	8	11
140	153	150	187	200	202	8	11
150	164	162	200	213	216	8	12
160	175	172	213	220	231	8	13
170	187	182	230	248	249	10	14
180	199	192	247	268	267	10	16
190	209	202	257	278	279	10	16
200	221	212	273	298	297	11	17

Ball screw support bearings mounting dimensions are shown in bearing dimension table.

10 Bearing mounting and adjustment

Machine tool performance, to a large extent, depends on the precision and dynamic performance of spindle components, which is directly related to spindle bearings mounting and adjustment.

The precision components for machine tool bearings, in mounting and adjusting process, are sensitive to improper operation. Inappropriate mounting will probably damage bearing and ruin bearing accuracy. Improper adjustment will lead to poor accuracy, low rigidity, high temperature rise, high noise or weak vibration resistance. Therefore, there must be a systematic set of operating instructions for precision bearing mounting and adjustment, with proper mounting and adjusting tools.

10.1 Preparation before mounting

Suggest that precision bearing packings be opened just before mounting.

The preparations before mounting precision bearing mainly include the following contents:

(1) Cleaning

To avoid bearing corrosion in transportation and stock, a layer of anti-rust oil should be added to precision bearing surface in packing. The incompatibility between lubrication oil or grease and anti-rust oil will lead poor lubrication, so clean the bearing carefully after opening the pack. If available, suggesting operator use plastic gloves, instead of touching bearings with naked hands.

① Clean bearing with clean and high purity gasoline, No. 90 gasoline and even No.120 white gasoline are suggesting.

② Cleaning bearings with two steps. Prepare two cleaning containers filled with enough gasoline, and place one piece of wire netting in one container. First immerse the bearing from packing into the container with wire netting, and then do the final cleaning in other container and rotating bearing. Renew the gasoline from time to time to guarantee the clarity.

Sealed bearings, unsuitable to clean, can directly mounting and use.

③ Dry the bearings after cleaning by air or in room temperature. Move to next step till the absolute drying.

④ If the bearings are lubricated with oil, try to mount the bearing without rotating it. If the bearings are lubricated with grease, we should turn to the following grease filling and mounting procedures.

⑤ It is suggested to paint a thin layer of lubrication oil on the mounting surface for the easy to mounting bearing.

(2) Filling grease

For grease lubrication bearings, improper selection of grease, grease mount or grease filling method will influence bearing performance and even service life. Therefore, be strict with the grease filling regulations.

① Select proper lubrication grease, and prepare injector with suitable size.

② Check the grease amount in Tab. 56 and 57, and fill such amount into injector.

③ Inject the grease into the groove through two adjacent rolling elements to ensure uniform distribution.

For filling grease into cylindrical roller bearings, fill 80% grease to inner ring raceway, rolling surface and surfaces of rollers and cage pockets, while grease the left 20% onto the outer raceway.

④ Rotate the bearing gently to distribute the grease in raceway, cage guiding surface, cage pockets and rollers surface uniformly.

10.2 Inspecting the accuracy of bearing associated components

(1) Fitting shaft and housing should be cleaned thoroughly, and make sure there are no burrs, rough edges and knocked marks.

(2) Check whether shaft and housing are match with bearing or not. See the references on fitting part.

(3) Check whether the highest runout is marked on the fitting between bearing and shaft and housing.

(4) Check the parallelism of sleeve or spacer and the perpendicularity of end face to axis, which should be controlled below 0.003mm.

10.3 Bearing mounting

Make regulations according to bearing types, fitting situations between bearing and shaft or housing, and present mounting conditions. No matter which mounting method will be adopted, we must adhere to one principle

that rolling elements carrying load is absolutely forbidden in the whole process of precision bearings mounting.

In general, the inner ring is interference fit on the shaft, while the outer ring is clearance fit in the housing, and also use microscale interference fit.

The bearings are mounted to shaft in the following methods:

(1) Making use of hammer and sleeve

This method is widely used to the small and medium size bearings with loose fit between rings and shaft or housing. The sleeve size should correspond to the selected bearing ring dimension. The sleeve bore diameter should be a little bigger than shaft diameter when inner ring being mounted, while the sleeve outer diameter should be a little smaller than housing hole diameter when outer ring being mounted. Avoid striking outer ring when inner ring is being mounted and avoid striking inner ring when outer ring is being mounted, or the striking force will be passed to the other ring through rolling elements and raceway, which will damage the raceway and rolling elements. If this method is used to seperable bearings with interference fit between rings and shaft or housing, the sleeve end face should contact with the end faces of inner ring and outer ring, moreover, the sleeve end face must be flat and be vertical to the sleeve centre line.

Mount bearings by hammer to strike sleeve, on the one hand, bearing is unstable; on the other hand, bearing will be given impact force. In general, it's not suggested to use this method to mount precision bearing.

(2) Using pressure devices

The pressure devices include press machine, hydraulic gripper, hydraulic clamp and hydraulic nut, etc. The feature of this method is to avoid direct striking bearings and relevant damage. However, adopting this method must gurantee the pressure line coincides with beaing axis to prevent bearing tilting.

(3) Heating inner ring

It's difficult to use pressure devices to mount the bearing when the magnitude of interference is larger, which does harm to bearing fitting surface. Therefore, it'll be easier to mount through heating and expanding inner ring.

At present, we usually use magnetic induction heater to heat the inner ring.

The heating temperature can not be more than 120°C. The heating temperature is decided by bearing dimensions and magnitude of interference.

In the process of being heated, the outer ring dimension will be expanded,therefore, there will be clearance between outer ring and shafter shoulder in axial direction after the outer ring cooling, it is interference fit between bearing and shaft after cooling. Therefore, we should use nut or other suitable methods to eliminate the axial clearance between bearing and shaft shoulder after bearing is cooling down.

(4) Injecting pressure oil on fitting surface

When there is interference between shaft and bearing, the friction between fitting surfaces will increase, even larger interference will damage fitting surfaces. Then injecting pressure oil on the fitting surfaces to form a layer of lubrication oil film to decrease the friction. In this way, less force can make the two parts slip relatively. This method suits for the mounting of taper fitting pieces and dismounting of cylinder fitting pieces.

10.4 Mounting matched angular contact ball bearings

Single-row angular contact ball bearings can only support the axial load in one direction, so more attention must be paid to bearing load-carrying direction. Fig. 20 shows different load-carrying directions of angular contact ball bearings with different types.

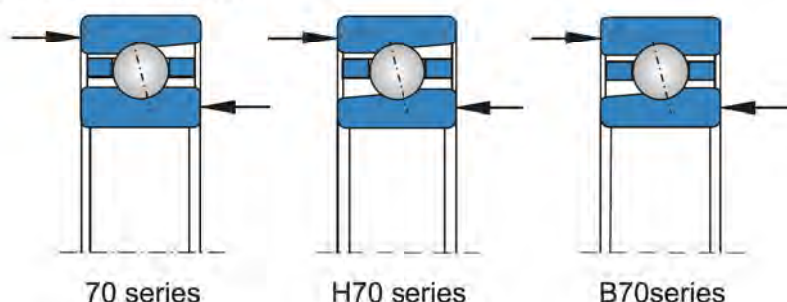

Fig. 20 Load-carrying directions of angular contact ball bearings

For paired bearings in DB and DF to be mounted, the positions of preload clearance are different, so attention should be paid to compression position of matched bearings, as is shown in Fig. 21.

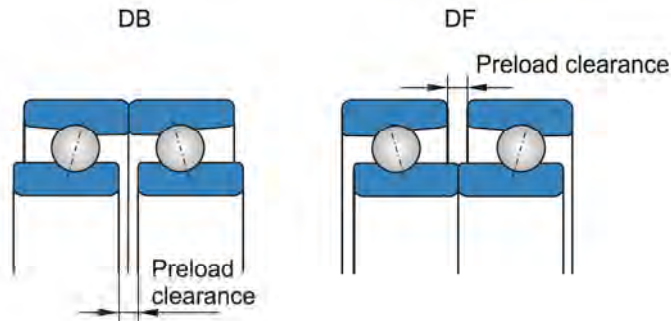

Fig. 21 Preload clearance of matched bearings

In addition, it's suggested to adopt directional assembly to mount precision bearings, thus we can guarantee the running accuracy of spindle components. For precision angular contact ball bearings, we mark the maximum runout of inner ring and outer ring on inner ring and outer ring respectively. The mounting procedures are as follows: first, maximum radial runout of inner ring should snap to maximum radial runout of outer ring in axial direction, then, adjust the circumferential position of the bearing sets to make maximum radial runout of inner ring and maximum radial runout of spindle journal in radial symmetry, in the same way, adjust outer ring and housing in radial symmetry, at last, bearing set should be preloaded according to designing.

10.4.1 Mounting of bearing sets in DB

- (1) Adjust the position of highest radial runout of inner ring, then mount the bearing to the predetermine position on spindle.
- (2) Tighten the locknut, and apply preload.
- (3) Adjust the circumferential position of outer ring, mount spindle components to bearing block, then mount end cap and the following operations.

10.4.2 Mounting of bearing sets in DF

- (1) Adjust the position of highest radial runout of outer ring, then mount the bearing to the predetermine position on spindle.
- (2) Mount end cover and apply preload to bearing.
- (3) Mount the spindle into the bearing ring, fasten the nut and then go on the following operations.

10.5 Fastening Bearing

10.5.1 Fastening inner ring

In order to fasten the inner ring on shaft, threads are designed on shaft to position the bearing through nuts. The perpendicularity of thread axis and end face and the fitting accuracy of threads are very important. If nuts manufacturing accuracy is not high enough, the nut will tilt. The tilting nut will give rise to curve shaft and ununiform preload distribution on bearings, which has direct influence on bearing running accuracy, rigidity and load capacity. Therefore, locking nuts must be adjusted and fastened to guarantee shaft running accuracy and avoid being loosening.

According to different preloads, the locking force of bearing depends on actual working condition and should be determined through test.

To eliminate or decrease the components positioning resistance in the process of mounting, it is suggested that to lock the nut through the moment that two or three times the usual locking force, then loosen the nut, finally fasten the nut through usual locking force.

To use locknut, threads must be machined on spindle which should be matched with high precision nut, moreover, there must be rotating imbalance on locknut, therefore, interference sleeve should be adopted as

bearing axial positioning component on some high-speed precision CNC machine tools or machining center. Please contact with ZYS for the usage of interference sleeve.

10.5.2 Fastening outer ring

Outer ring is fastened into housing by pressing end cap and tightening screw bolt. If the bolt tightening force is too strong or end cap carries uneven loads, outer ring groove will be deformed. Therefore, bolt tightening force must be controlled. In addition, controlling the axial preload clearance between end cap and housing end face to guarantee correct positioning of outer ring.

It is suggested that the axial preload clearance between end cap and housing end face should be controlled in the range of 0.01 ~ 0.04mm.

10.6 Mounting and adjusting the cylindrical roller bearings (tapered bore)

Adjusting the radial clearance of cylindrical roller bearings with tapered bore depends on the axial movement of inner ring on tapered journal. Main mounting methods include empirical method, calculating method, direct controlling method through measuring instruments, etc.

(1) Empirical method

Operator relies on his own mounting experience, hand feeling and necessary devices to mount bearing. For the mounting process of cylindrical roller bearings with tapered bore, first mount inner ring, cage and rollers to spindle, and tighten locknut to make bearing tapered bore close to tapered journal, and then put the spindle unit into housing, adjust nut until bearing radial clearance decrease to interference. Whether the bearing clearance or interference is suitable or not is judged by operator's handfeel when rotating the spindle. If the interference amount is too much, there is resistance for operator. Rotating spindle too swiftly means too large bearing clearance. Therefore, empirical method is to grasp the handfeel when rotating spindle.

Another way to judge whether there is clearance or not in adjusting process: fix dial gauge support, place gauge contacting head on locating surface of spindle front end, put up spindle head with strength, if gauge needle moves, there is radial clearance in bearing, so bearing clearance can be calculated by gauge needle runout.

(2) Calculating method

Cylindrical roller bearings for machine tool spindle has the tapered bore with the taper 1: 12. When bearing is mounted on tapered shaft and moves in axial direction, the bearing tapered bore will be expanded. The diameter expansion is equivalent to the reduction of bearing radial clearance. The reduction of bearing clearance is connected not only with axial movement but also with journal surface roughness, inner ring width and shaft bore diameter.

The following formula is used to calculate axial movement, when mounting and adjusting cylindrical roller bearings with tapered bore in axial direction.

$$B_a = \frac{ec}{1000}$$

In the formula: B_a —the axial movement of bearing inner ring relative to spindle

e — coefficient for different bearing series

c — the reduction of bearing clearance (μm), e.g. original radial clearance is $10\ \mu\text{m}$, if $2\ \mu\text{m}$ interference is requested, $c=12\ \mu\text{m}$.

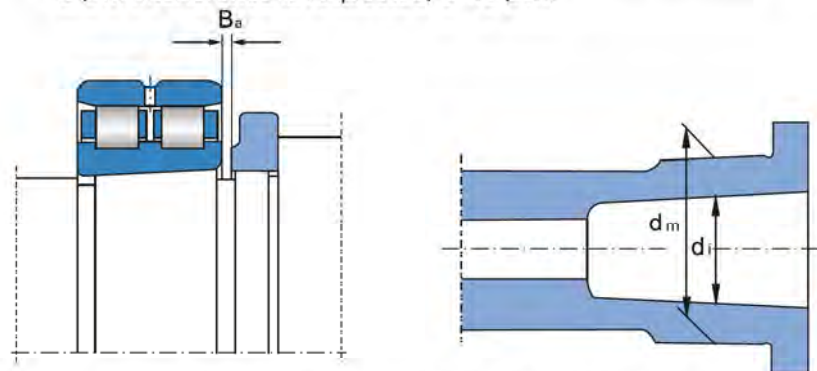

Fig. 22 Figure for mounting cylindrical roller bearings with tapered bore

Tab. 79 Coefficients for different bearing series

Diameter ratio d/d_m	Coefficient e	
	NN30K、N10K	NNU49K、N19K
≤ 0.2	12.5	12.0
0.3	14.5	13.0
0.4	15.0	14.0
0.5	16.0	15.0
0.6	17.0	16.0
0.7	18.0	17.0

(3) Direct controlling method through measuring instruments

Special clearance measuring instrument for cylindrical roller bearings is used to control bearing radial clearance through measuring the circumscribed circle diameter of bearing rolling elements and bearing outer raceway diameter after being mounted into housing.

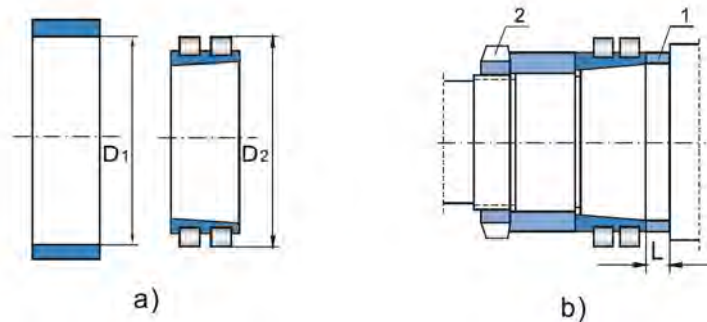

Fig. 23 Mounting cylindrical roller bearings

As shown in Fig. 24, first mount inner ring, cage and rolling elements onto spindle, and use the clearance measuring instrument for cylindrical roller bearings to measure the circumscribed circle diameter D_2 of rolling elements when bearing is moving in axial direction, then use bore diameter measuring instrument to measure bearing outer raceway diameter D_1 after being mounted into housing, finally, bearing radial clearance will be calculated. Therefore, according to the required clearance in mounting and adjusting, controlling the circumscribed circle diameter D_2 of rolling elements and further controlling spacer width will give preload to cylindrical roller bearings.

11 Machine tool bearings mounting examples

The basic requirements for spindle:

- (1) High running accuracy
- (2) High speed
- (3) Wide range of speed
- (4) High rigidity
- (5) Low temperature rise
- (6) High reliability

Some of the above requirements are in confrontation, so it is almost impossible for spindle to meet all the above requirements simultaneously. Therefore, the main performance of spindle should be taken into consideration when designing spindle supporting. Bearing types and matched method depend on machine tool different performances.

Fig. 24 to Fig. 39 are typical structures of machine tool spindle and ball screw support.

(1) Lathe

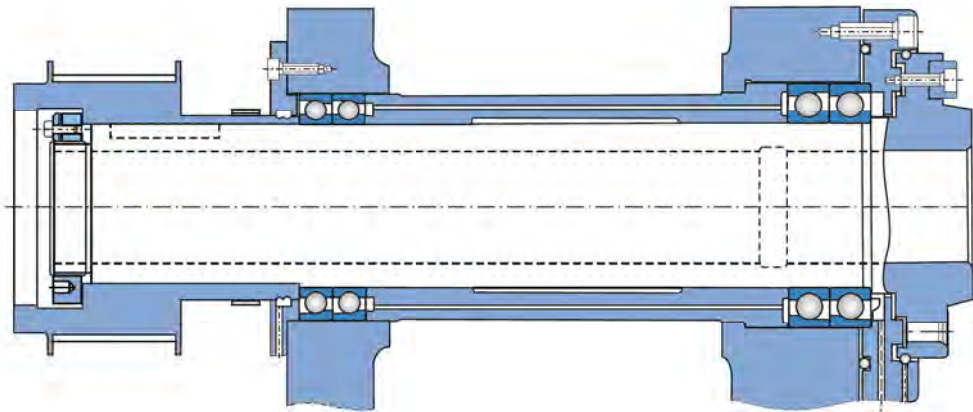

Fig. 24 Super-speed CNC lathe spindle

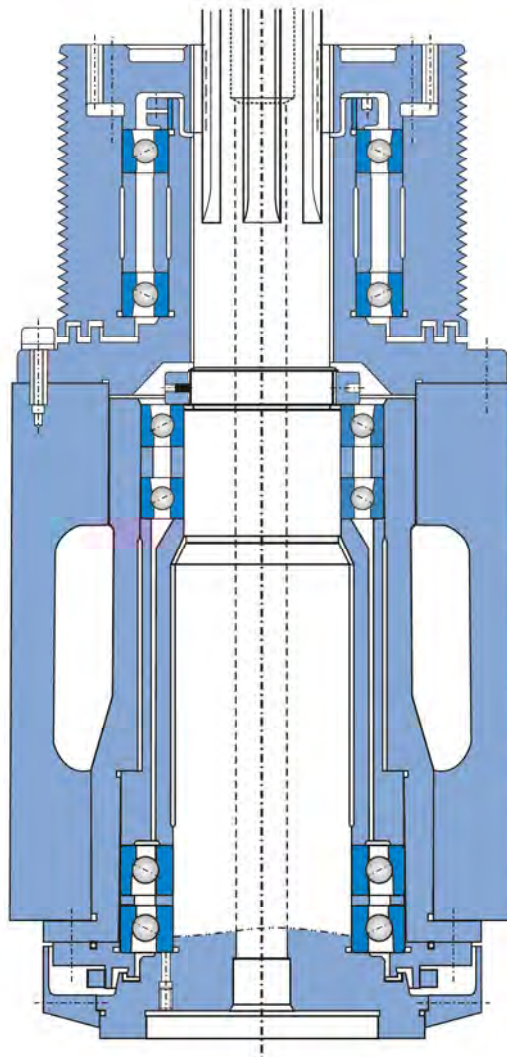

Fig. 25 Vertical lathe spindle

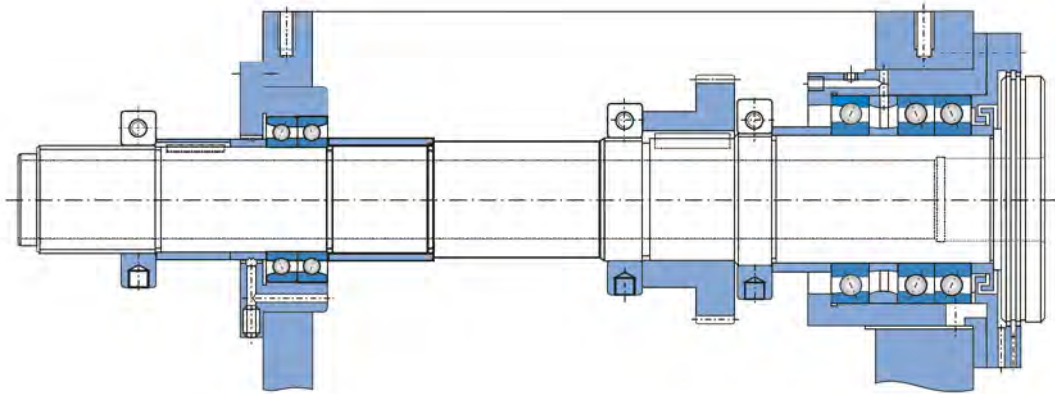

Fig. 26 High-speed lathe spindle

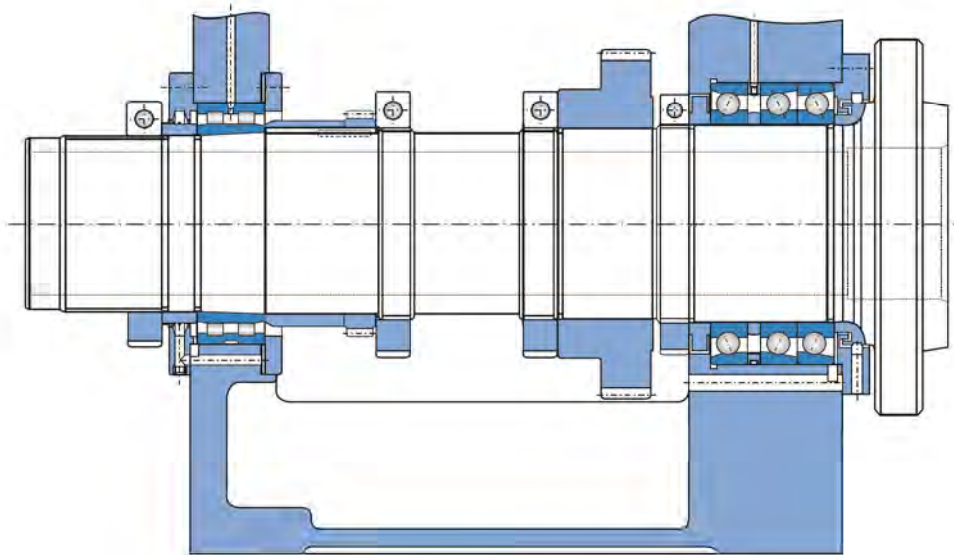

Fig. 27 High rigidity lathe spindle

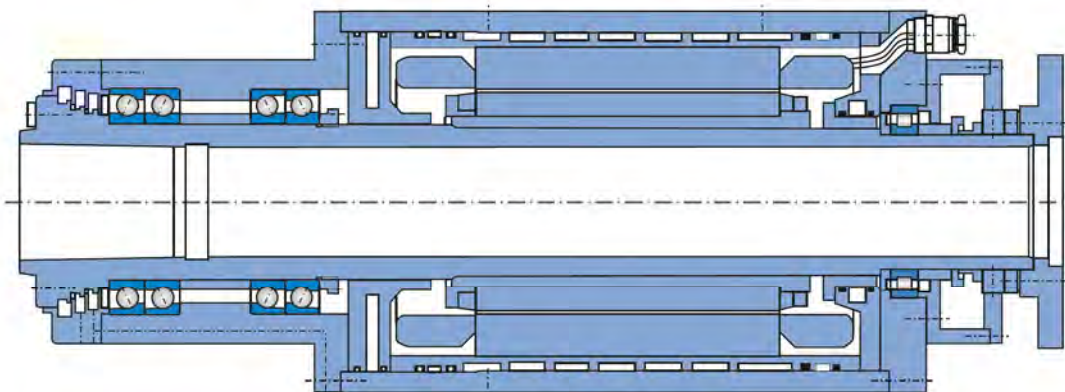

Fig. 28 Lathe electric spindle

(2) Grinding machine

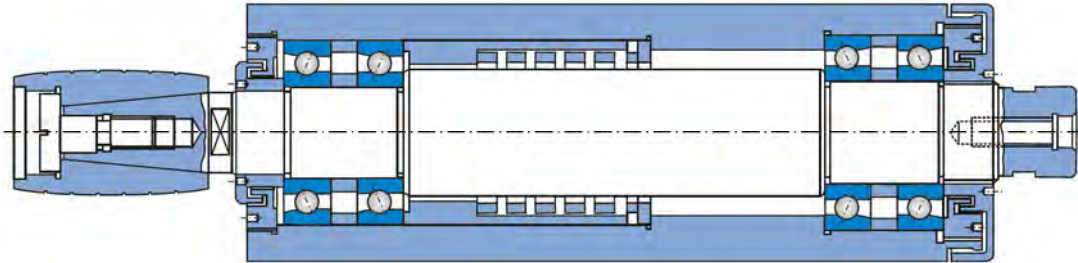

Fig. 29 Spindle for bore diameter grinding machine

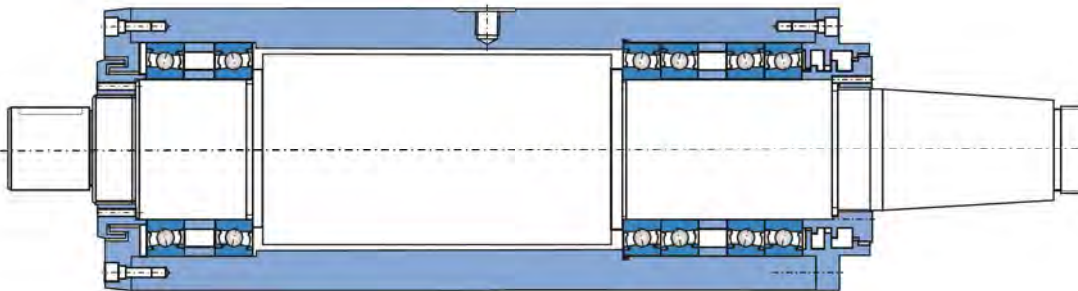

Fig. 30 Spindle for outer diameter grinding machine

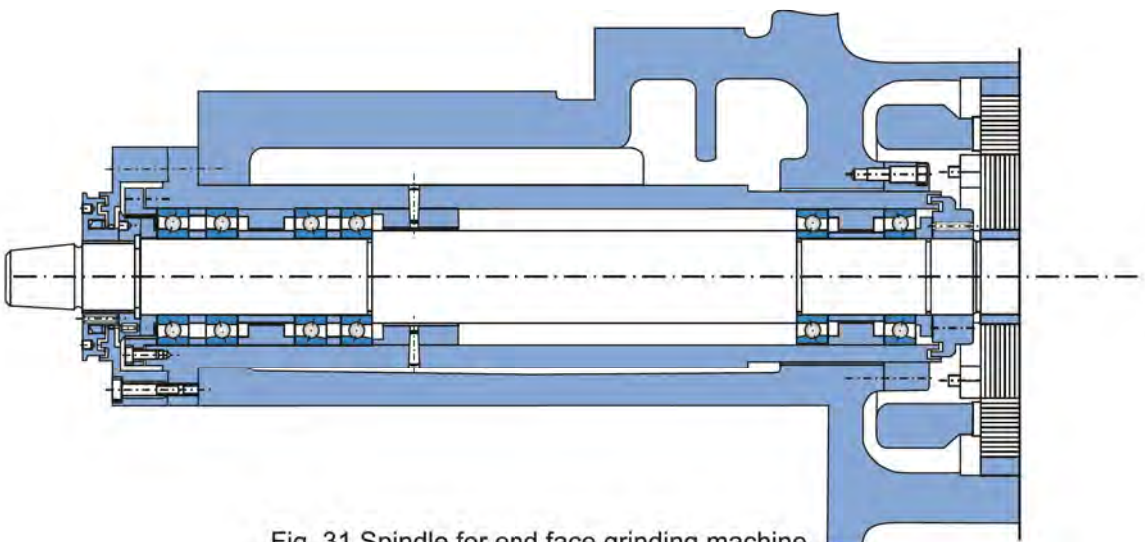

Fig. 31 Spindle for end face grinding machine

(3) Boring machine, milling machine, drilling machine

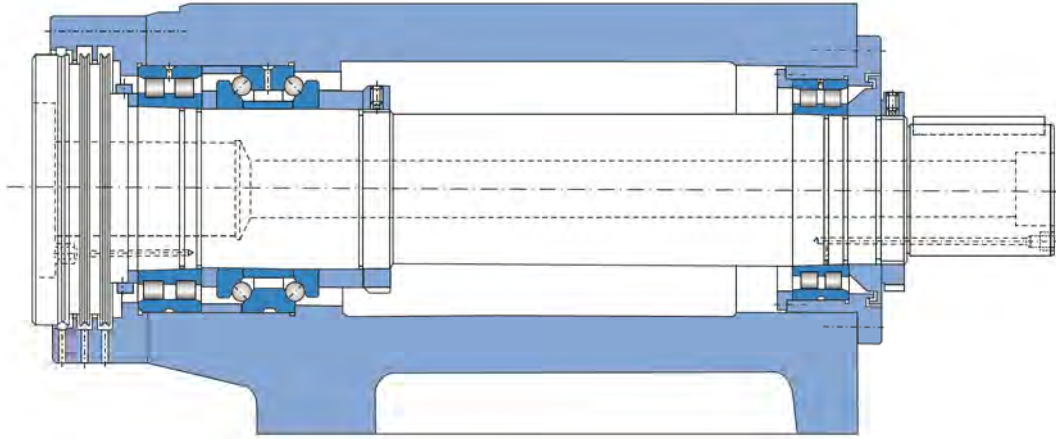

Fig. 32 Spindle for precision boring machine

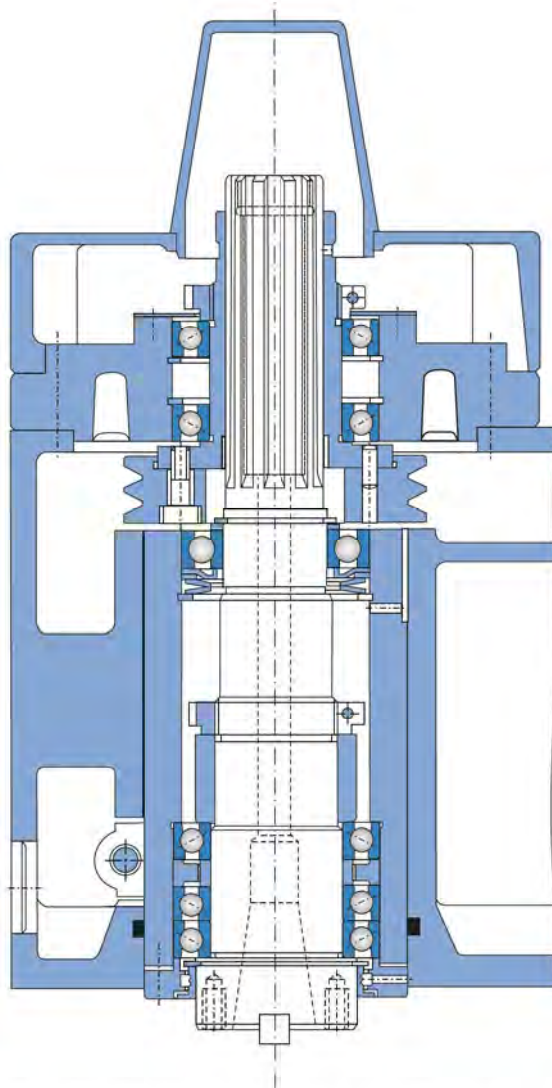

Fig. 33 Vertical high-speed milling spindle

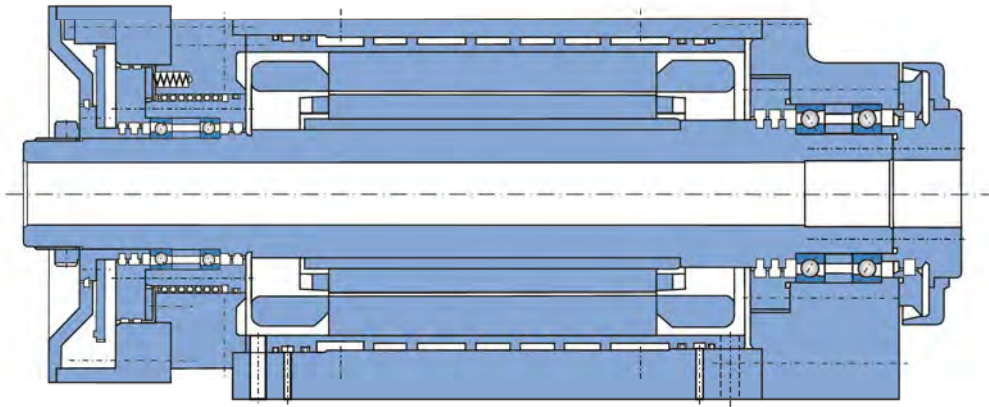

Fig. 34 Spindle for high-speed milling machine

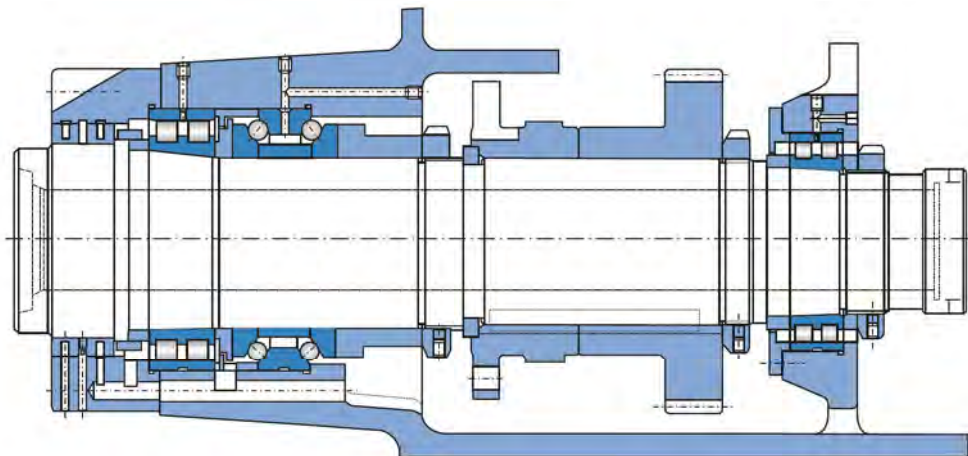

Fig. 35 Spindle for precision milling machine and drilling machine

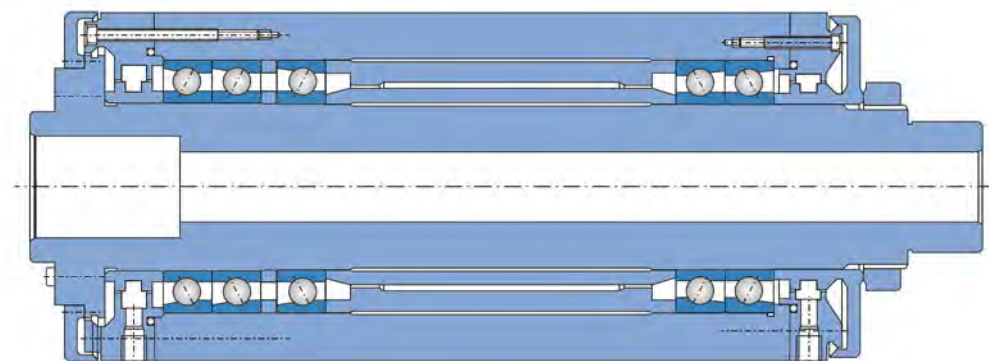

Fig. 36 Spindle for drilling machine

(4) Machining center

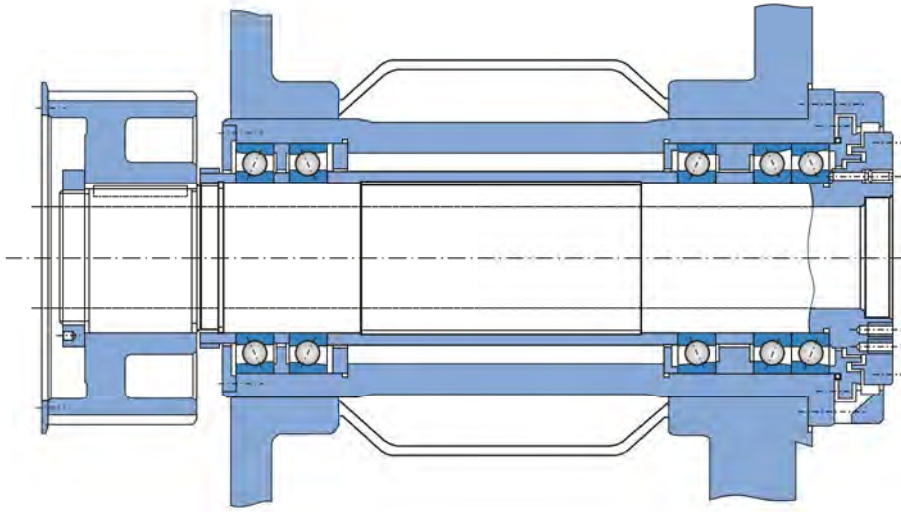

Fig. 37 Spindle for machining center

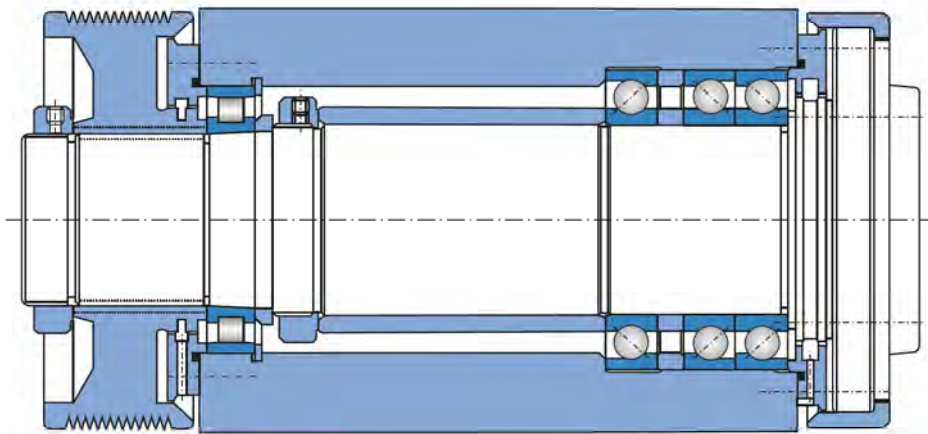

Fig. 38 Spindle for turning center

(5) Ball screw support

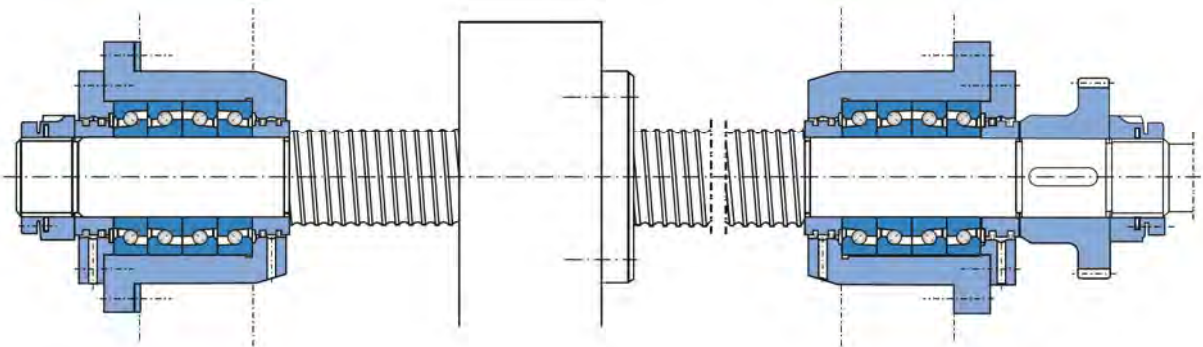

Fig. 39 Ball screw support

Designation of angular contact ball bearings

7 0 05 c 2 RZ / HQ 1 P4 DB A

Ball				
	B7	H7	7	V7
ball size	small	> 7 th series	medium	large
speed	+++	++	++	+
stiffness	+	++	++	+++
seal	-	✓	-	-







Dimensional series		
18	ISO	18
19	ISO	19
(1)0	ISO	10
(0)2	ISO	02

Bore dimension (mm)	
00	10 mm
01	12 mm
02	15 mm
03	17 mm
04	4x5=20 mm
05	5x5=25 mm
...	

Contact angle	
C	15°
AC	25°

seal
2 RZ

Preload type	
A	light
B	medium
C	high
D	special

Matched sets	
G	Single bearing for universal matching
DB	 O-Arrangement
DF	 X-Arrangement
DT	 Tandem-Arrangement
TBT	 Tandem- and O-Arrangement
QBC	 Tandem-O-Arrangement
QBT	 Tandem- and O-Arrangement

Precision class	
P2	ISO 2
P4A	better than ISO 4
P4	ISO 4
P5	ISO 5

Material change of bearing parts
hybrid bearing
HQ 1 ceramic balls

High-speed angular contact ball bearings
718 C
Contact Angle $\alpha = 15^\circ$
718 AC
Contact angle $\alpha = 25^\circ$

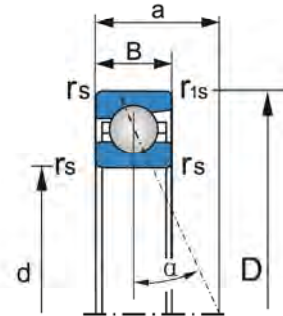

Bearing designations ZYS	Boundary dimensions						Load rating		Limiting speed		Weight kg ≈
	d	D	B	r _{smin}	r _{1smin}	a	C _r	C _{or}	Grease	Oil	
	mm						≈	KN		r/min	
71800 C	10	19	5	0.30	0.10	4	1.8	1.1	75000	120000	0.005
71800 AC	10	19	5	0.30	0.10	6	1.7	1.1	70000	110000	0.005
71801 C	12	21	5	0.30	0.10	5	2.0	1.4	70000	110000	0.006
71801 AC	12	21	5	0.30	0.10	6	1.9	1.3	63000	95000	0.006
71802 C	15	24	5	0.30	0.10	5	2.2	1.8	60000	90000	0.007
71802 AC	15	24	5	0.30	0.10	7	2.1	1.7	53000	80000	0.007
71803 C	17	26	5	0.30	0.10	5	2.3	1.9	53000	80000	0.008
71803 AC	17	26	5	0.30	0.10	7	2.1	1.8	50000	75000	0.008
71804 C	20	32	7	0.30	0.10	7	3.9	3.4	45000	67000	0.018
71804 AC	20	32	7	0.30	0.10	9	3.7	3.2	40000	60000	0.018
71805 C	25	37	7	0.30	0.15	8	4.2	4.1	38000	56000	0.022
71805 AC	25	37	7	0.30	0.15	11	3.9	3.9	34000	50000	0.022
71806 C	30	42	7	0.30	0.15	8	4.4	4.8	32000	48000	0.025
71806 AC	30	42	7	0.30	0.15	12	4.1	4.5	28000	43000	0.025
71807 C	35	47	7	0.30	0.15	9	4.6	5.5	26000	40000	0.029
71807 AC	35	47	7	0.30	0.15	13	4.3	5.2	24000	38000	0.029
71808 C	40	52	7	0.30	0.15	10	4.8	6.2	24000	38000	0.032
71808 AC	40	52	7	0.30	0.15	14	4.5	5.8	20000	34000	0.032
71809 C	45	58	7	0.30	0.15	10	4.9	6.7	20000	34000	0.040
71809 AC	45	58	7	0.30	0.15	14	4.6	6.3	18000	30000	0.040
71810 C	50	65	7	0.30	0.15	11	7.4	10.0	18000	30000	0.052
71810 AC	50	65	7	0.30	0.15	17	6.9	9.5	16000	26000	0.052
71811 C	55	72	9	0.30	0.15	13	10.2	13.8	16000	26000	0.081
71811 AC	55	72	9	0.30	0.15	19	9.6	13.1	15000	24000	0.081
71812 C	60	78	10	0.30	0.15	14	13.4	18.0	15000	24000	0.100
71812 AC	60	78	10	0.30	0.15	21	12.6	17.0	14000	22000	0.100
71813 C	65	85	10	0.60	0.15	15	13.4	18.8	14000	22000	0.125
71813 AC	65	85	10	0.60	0.15	22	12.6	17.8	13000	20000	0.125

High-speed angular contact ball bearings

718 C

Contact Angle $\alpha = 15^\circ$

718 AC

Contact angle $\alpha = 25^\circ$

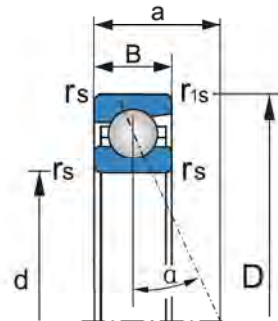

Bearing designations ZYS	Boundary dimensions						Load rating		Limiting speed		Weight kg ≈
	d	D	B	r _{smin}	r _{1smin}	a	C _r	C _{or}	Grease	Oil	
	mm						≈	KN		r/min	
71814 C	70	90	10	0.60	0.15	16	13.8	20.3	13000	20000	0.133
71814 AC	70	90	10	0.60	0.15	24	13.0	19.1	12000	19000	0.133
71815 C	75	95	10	0.60	0.15	16	14.2	21.7	12000	19000	0.142
71815 AC	75	95	10	0.60	0.15	25	13.3	20.5	11000	18000	0.142
71816 C	80	100	10	0.60	0.15	17	14.5	23.1	11000	18000	0.150
71816 AC	80	100	10	0.60	0.15	26	13.6	21.8	9500	16000	0.150
71817 C	85	110	13	1.00	0.30	20	21.5	32.2	10000	17000	0.262
71817 AC	85	110	13	1.00	0.30	29	20.2	30.5	9000	15000	0.262
71818C	90	115	13	1.00	0.30	20	21.7	33.5	9500	16000	0.274
71818AC	90	115	13	1.00	0.30	30	20.4	31.6	8500	14000	0.274
71819C	95	120	13	1.00	0.30	21	21.9	34.7	9000	15000	0.287
71819AC	95	120	13	1.00	0.30	32	20.6	32.8	8500	14000	0.287
71820C	100	125	13	1.00	0.30	22	22.5	37.0	8500	14000	0.301
71820AC	100	125	13	1.00	0.30	33	21.2	34.9	8000	13000	0.301
71821C	105	130	13	1.00	0.30	22	22.7	38.3	8500	14000	0.314
71821AC	105	130	13	1.00	0.30	34	21.3	36.1	8000	13000	0.314
71822C	110	140	16	1.00	0.30	25	31.8	51.6	8000	13000	0.496
71822AC	110	140	16	1.00	0.30	37	29.9	48.7	7500	12000	0.496
71824C	120	150	16	1.00	0.30	26	33.1	56.9	7000	11000	0.537
71824AC	120	150	16	1.00	0.30	39	31.1	53.7	6700	10000	0.537
71826C	130	165	18	1.10	0.60	29	38.7	67.6	6700	10000	0.782
71826AC	130	165	18	1.10	0.60	43	36.3	63.8	6000	9000	0.782
71828C	140	175	18	1.10	0.60	30	44.8	79.2	6000	9000	0.813
71828AC	140	175	18	1.10	0.60	46	42.0	74.7	5600	8500	0.813
71830C	150	190	20	1.10	0.60	33	51.2	92.0	5600	8500	1.14
71830AC	150	190	20	1.10	0.60	50	48.0	86.8	5000	7500	1.14
71832C	160	200	20	1.10	0.60	34	52.4	97.7	5000	7500	1.21
71832AC	160	200	20	1.10	0.60	52	49.2	92.2	4800	7000	1.21

High-speed angular contact ball bearings
718 C
Contact Angle $\alpha = 15^\circ$
718 AC
Contact angle $\alpha = 25^\circ$

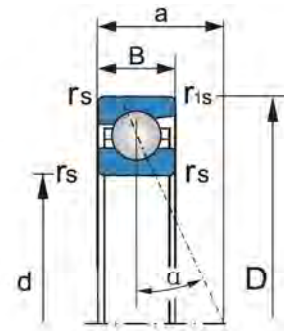

Bearing designations ZYS	Boundary dimensions						Load rating		Limiting speed		Weight kg ≈
	d	D	B	r _{smin}	r _{1smin}	a	C _r	C _{or}	Grease	Oil	
	mm						≈	KN		r/min	
71834C	170	215	22	1.10	0.60	37	66.5	123.4	4800	7000	1.61
71834AC	170	215	22	1.10	0.60	56	62.4	116.5	4300	6300	1.61
71836C	180	225	22	1.10	0.60	38.1	71	127.8	4500	6700	1.70
71836AC	180	225	22	1.10	0.60	58.2	67	120.5	4000	6000	1.70
71838C	190	240	24	1.50	0.60	40.8	80	130.7	4300	6300	2.20
71838AC	190	240	24	1.50	0.60	62.1	75	123.3	3800	5600	2.20
71840C	200	250	24	1.50	0.60	42.1	81.5	139.2	4000	6000	2.30
71840AC	200	250	24	1.50	0.60	64.5	76.5	131.1	3600	5300	2.30
71844C	220	270	24	1.50	0.60	44.8	83	148.0	3800	5600	2.50
71844AC	220	270	24	1.50	0.60	69.1	78	139.4	3400	5000	2.50
71848C	240	300	28	2.00	1.00	50.2	106	184.5	3400	5000	3.90
71848AC	240	300	28	2.00	1.00	77.0	98	174.0	3000	4500	3.90
71852C	260	320	28	2.00	1.10	52.9	107	191.9	3200	4800	4.20
71852AC	260	320	28	2.00	1.10	81.6	100	180.5	3000	4500	4.20
71856C	280	350	33	2.00	1.10	58.7	132	235.6	3000	4500	6.20
71856AC	280	350	33	2.00	1.10	89.9	124	222.3	2600	4000	6.20
71860C	300	380	38	2.10	1.10	64.6	171	300.2	2600	4000	8.70
71860AC	300	380	38	2.10	1.10	98.3	161	285.0	2400	3800	8.70
71864C	320	400	38	2.10	1.10	67.2	175	321.1	2400	3800	9.00
71864AC	320	400	38	2.10	1.10	102.9	165	302.1	2200	3600	9.00
71868C	340	420	38	2.10	1.10	69.9	179	340.1	2200	3600	9.20
71868AC	340	420	38	2.10	1.10	107.6	169	321.1	2000	3400	9.20
71872C	360	440	38	2.10	1.10	72.6	183	359.1	2000	3400	10.30
71872AC	360	440	38	2.10	1.10	112.3	173	338.2	1800	3000	10.30

High-speed angular contact ball bearings

719 C

Contact angle $\alpha = 15^\circ$

719 AC

Contact angle $\alpha = 25^\circ$

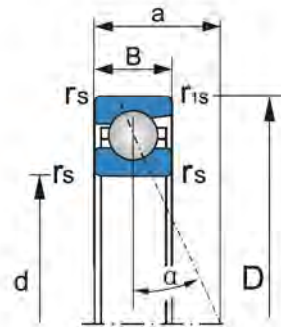

Bearing designations ZYS	Boundary dimensions						Load rating		Limiting speed		Weight kg ≈
	d	D	B	r _{smin}	r _{1smin}	a	C _r	C _{0r}	Grease	Oil	
	mm					≈	KN		r/min		
719/8 C	8	19	6	0.30	0.10	5	2.5	1.5	75000	120000	0.01
719/8 AC	8	19	6	0.30	0.10	6	2.3	1.3	67000	100000	0.01
71900 C	10	22	6	0.30	0.10	5	2.9	1.8	70000	110000	0.01
71900 AC	10	22	6	0.30	0.10	7	2.7	1.7	67000	100000	0.01
71901 C	12	24	6	0.30	0.10	5	3.2	2.2	63000	95000	0.01
71901 AC	12	24	6	0.30	0.10	7	3.1	2.1	56000	85000	0.01
71902 C	15	28	7	0.30	0.10	6	4.8	3.4	53000	80000	0.02
71902 AC	15	28	7	0.30	0.10	9	4.6	3.2	50000	75000	0.02
71903 C	17	30	7	0.30	0.10	7	5.1	3.8	50000	75000	0.02
71903 AC	17	30	7	0.30	0.10	9	4.8	3.6	45000	67000	0.02
71904 C	20	37	9	0.30	0.15	8	7.4	5.8	40000	60000	0.04
71904 AC	20	37	9	0.30	0.15	11	7.0	5.6	38000	56000	0.04
71905 C	25	42	9	0.30	0.15	9	7.6	6.5	34000	50000	0.04
71905 AC	25	42	9	0.30	0.15	12	7.2	6.2	30000	45000	0.04
71906 C	30	47	9	0.30	0.15	10	8.0	7.6	30000	45000	0.05
71906 AC	30	47	9	0.30	0.15	13	7.6	7.2	26000	40000	0.05
71907 C	35	55	10	0.60	0.15	11	11	10.9	26000	40000	0.07
71907 AC	35	55	10	0.60	0.15	16	10.4	10.3	20000	34000	0.07
71908 C	40	62	12	0.60	0.15	13	14	14.2	20000	34000	0.11
71908 AC	40	62	12	0.60	0.15	18	13.3	13.5	18000	30000	0.11
71909 C	45	68	12	0.60	0.15	14	14.7	16.1	18000	30000	0.13
71909 AC	45	68	12	0.60	0.15	19	13.9	15.2	17000	28000	0.13
71910 C	50	72	12	0.60	0.15	14	19	21.2	17000	28000	0.13
71910 AC	50	72	12	0.60	0.15	20	17.9	20.1	15000	24000	0.13
71911 C	55	80	13	1.00	0.30	16	23.7	27.4	15000	24000	0.18
71911 AC	55	80	13	1.00	0.30	22	22.4	26	14000	22000	0.18
71912 C	60	85	13	1.00	0.30	16	24.8	30.3	14000	22000	0.19
71912 AC	60	85	13	1.00	0.30	23	23.3	28.7	13000	20000	0.19
71913 C	65	90	13	1.00	0.30	17	25.1	31.9	13000	20000	0.20
71913 AC	65	90	13	1.00	0.30	25	23.6	30.2	12000	19000	0.20
71914 C	70	100	16	1.00	0.30	19	34.5	43.4	12000	19000	0.33
71914 AC	70	100	16	1.00	0.30	28	32.6	41.2	11000	18000	0.33

High-speed angular contact ball bearings

719 C

Contact angle $\alpha = 15^\circ$

719 AC

Contact angle $\alpha = 25^\circ$

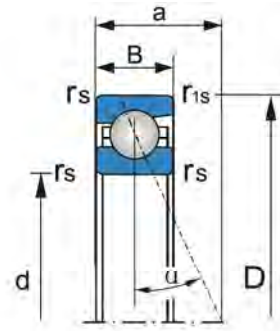

Bearing designations ZYS	Boundary dimensions						Load rating		Limiting speed		Weight kg ≈
	d	D	B	r _{smin}	r _{1smin}	a	C _r	C _{or}	Grease	Oil	
	mm					≈	KN		r/min		
71915 C	75	105	16	1.00	0.30	20	25	45.6	11000	18000	0.35
71915 AC	75	105	16	1.00	0.30	29	33	43.2	9500	16000	0.35
71916C	80	110	16	1.00	0.30	21	35.5	47.8	10000	17000	0.37
71919AC	80	110	16	1.00	0.30	30	33.5	45.3	9000	15000	0.37
71917 C	85	120	18	1.10	0.60	23	46.5	61.9	9500	16000	0.53
71917 AC	85	120	18	1.10	0.60	33	43.8	58.6	8500	14000	0.53
71918 C	90	125	18	1.10	0.60	23	47.2	64.8	9000	15000	0.56
71918 AC	90	125	18	1.10	0.60	34	44.5	61.4	8000	13000	0.56
71919 C	95	130	18	1.10	0.60	24	47.9	67.8	9000	15000	0.58
71919 AC	95	130	18	1.10	0.60	35	45.2	64.1	8000	13000	0.58
71920 C	100	140	20	1.10	0.60	26	60.4	84.4	8500	14000	0.79
71920 AC	100	140	20	1.10	0.60	38	56.9	79.9	8000	13000	0.79
71921 C	105	145	20	1.10	0.60	27	61.4	88.2	8000	13000	0.83
71921 AC	105	145	20	1.10	0.60	39	57.8	83.5	7500	12000	0.83
71922 C	110	150	20	1.10	0.60	27	62.3	91.9	7500	12000	0.86
71922 AC	110	150	20	1.10	0.60	40	58.7	87	7000	11000	0.86
71924 C	120	165	22	1.10	0.60	30	73.7	107.6	7000	11000	1.17
71924 AC	120	165	22	1.10	0.60	44	69.5	101.9	6700	10000	1.17
71926 C	130	180	24	1.50	0.60	33	76.3	117.1	6700	10000	1.58
71926 AC	130	180	24	1.50	0.60	48	71.9	110.9	6000	9000	1.58
71928 C	140	190	24	1.50	0.60	34	78.9	126.4	6000	9000	1.68
71928 AC	140	190	24	1.50	0.60	50	74.4	119.7	5600	8500	1.68
71930 C	150	210	28	2.00	1.00	38	118.2	175.1	5600	8500	2.48
71930 AC	150	210	28	2.00	1.00	56	111.4	165.8	5000	7500	2.48
71932 C	160	220	28	2.00	1.00	39	123.6	191.2	5000	7500	2.64
71932 AC	160	220	28	2.00	1.00	58	116.5	181.1	4800	7000	2.64
71934 C	170	230	28	2.00	1.00	41	125.7	200.0	4800	7000	2.77
71934 AC	170	230	28	2.00	1.00	61	118.5	189.4	4300	6300	2.77
71936 C	180	250	33	2.00	1.00	45	159.7	249.1	4500	6700	4.10
71936 AC	180	250	33	2.00	1.00	67	150.6	235.9	4000	6000	4.10
71938 C	190	260	33	2.00	1.00	47	162.8	260.8	4300	6300	4.29
71938 AC	190	260	33	2.00	1.00	69	153.5	247.0	3800	5600	4.29

High-speed angular contact ball bearings

719 C

Contact angle $\alpha = 15^\circ$

719 AC

Contact angle $\alpha = 25^\circ$

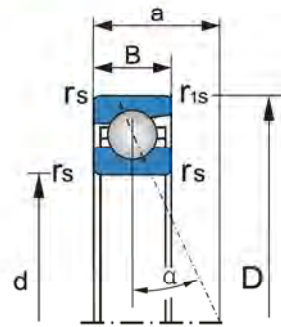

Bearing designations ZYS	Boundary dimensions						Load rating		Limiting speed		Weight kg ≈
	d	D	B	r _{smin}	r _{1smin}	a	C _r	C _{or}	Grease	Oil	
	mm					≈	KN		r/min		
71940 C	200	280	38	2.00	1.00	51	198.4	311.4	3800	5600	6.02
71940 AC	200	280	38	2.00	1.00	75	187.1	294.9	3600	5300	6.02
71944 C	220	300	38	2.10	1.00	54	206.6	341.1	3600	5300	6.52
71944 AC	220	300	38	2.10	1.00	80	194.8	323.0	3200	4800	6.52
71948 C	240	320	38	2.10	1.00	56	219.2	384.2	3200	4800	7.07
71948 AC	240	320	38	2.10	1.00	84	206.7	363.8	3000	4500	7.07
71952 C	260	360	46	2.10	1.00	64	284.6	528.8	3000	4500	12.0
71952 AC	260	360	46	2.10	1.00	95	268.3	500.8	2600	4000	12.0
71956 C	280	380	46	2.10	1.00	67	288.7	554.6	2600	4000	12.7
71956 AC	280	380	46	2.10	1.00	100	272.2	525.5	2200	3600	12.7
71960C	300	420	56	3.00	1.10	76.2	360	570	2400	3800	20.4
71960AC	300	420	56	3.00	1.10	111.9	340	540	2200	3600	20.4
71964C	320	440	56	3.00	1.10	78.9	375	620	2200	3600	21.6
71964AC	320	440	56	3.00	1.10	116.6	355	585	2000	3400	21.6
71968C	340	460	56	3.00	1.10	81.6	380	640	2200	3600	22.7
71968AC	340	460	56	3.00	1.10	121.3	360	610	1900	3200	22.7
71972C	360	480	56	3.00	1.10	84.3	390	695	2000	3400	23.9
71972AC	360	480	56	3.00	1.10	125.9	375	640	1800	3000	23.9
71976C	380	520	65	4.00	1.50	92.8	460	810	1900	3200	34.3
71976AC	380	520	65	4.00	1.50	137.4	430	770	1700	2800	34.3
71980C	400	540	65	4.00	1.50	95.5	470	850	1800	3000	35.5
71980AC	400	540	65	4.00	1.50	142.1	440	800	1600	2600	35.5
71984C	420	560	65	4.00	1.50	98.1	480	890	1700	2800	37.6
71984AC	420	560	65	4.00	1.50	146.7	450	840	1500	2400	37.6
71988C	440	600	74	4.00	1.50	106.7	500	950	1600	2600	51.5
71988AC	440	600	74	4.00	1.50	158.2	470	900	1500	2400	51.5
71992C	460	620	74	4.00	1.50	109.3	510	1080	1500	2400	54.5
71992AC	460	620	74	4.00	1.50	162.9	490	1000	1400	2200	54.5

High-speed angular contact ball bearings

70 C

Contact angle $\alpha = 15^\circ$

70 AC

Contact angle $\alpha = 25^\circ$

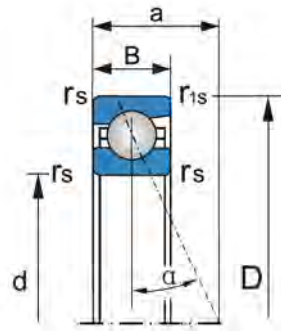

Bearing designations ZYS	Boundary dimensions						Load rating		Limiting speed		Weight kg ≈
	d	D	B	r _{smin}	r _{1smin}	a	C _r	C _{or}	Grease	Oil	
	mm						≈	KN		r/min	
708 C	8	22	7	0.30	0.15	5.5	3.0	1.6	70000	110000	0.01
708 AC	8	22	7	0.30	0.15	7	2.8	1.5	63000	95000	0.01
7000 C	10	26	8	0.30	0.15	6	4.0	2.4	67000	100000	0.02
7000 AC	10	26	8	0.30	0.15	8	3.8	2.3	60000	90000	0.02
7001 C	12	28	8	0.30	0.15	7	5.0	3.0	60000	90000	0.02
7001 AC	12	28	8	0.30	0.15	9	4.8	2.8	56000	85000	0.02
7002 C	15	32	9	0.30	0.15	8	5.3	3.3	50000	75000	0.03
7002 AC	15	32	9	0.30	0.15	10	5.1	3.1	45000	67000	0.03
7003 C	17	35	10	0.30	0.15	8	6.7	4.9	45000	67000	0.04
7003 AC	17	35	10	0.30	0.15	11	6.4	4.7	40000	60000	0.04
7004 C	20	42	12	0.60	0.15	10	9.6	6.3	38000	56000	0.06
7004 AC	20	42	12	0.60	0.15	13	9.2	6.0	34000	50000	0.06
7005 C	25	47	12	0.60	0.15	11	12.9	8.7	34000	50000	0.07
7005 AC	25	47	12	0.60	0.15	14	12.3	8.3	30000	45000	0.07
7006 C	30	55	13	1.00	0.30	12	15.7	11.6	28000	43000	0.11
7006 AC	30	55	13	1.00	0.30	17	14.9	10.9	24000	38000	0.11
7007 C	35	62	14	1.00	0.30	13	19.3	17.5	20000	34000	0.15
7007 AC	35	62	14	1.00	0.30	18	18.3	16.6	19000	32000	0.15
7008 C	40	68	15	1.00	0.30	15	19.9	19.1	19000	32000	0.19
7008 AC	40	68	15	1.00	0.30	20	18.9	18.2	17000	28000	0.19
7009 C	45	75	16	1.00	0.30	16	26.7	25.3	17000	28000	0.23
7009 AC	45	75	16	1.00	0.30	22	25.4	24.1	16000	26000	0.23
7010 C	50	80	16	1.00	0.30	17	27.6	27.5	16000	26000	0.25
7010 AC	50	80	16	1.00	0.30	23	26.2	26.2	15000	24000	0.25
7011 C	55	90	18	1.10	0.60	19	36.7	37.1	14000	22000	0.37
7011 AC	55	90	18	1.10	0.60	26	34.8	35.3	13000	20000	0.37
7012 C	60	95	18	1.10	0.60	19	37.8	40	14000	22000	0.39
7012 AC	60	95	18	1.10	0.60	27	35.8	38	12000	19000	0.39

High-speed angular contact ball bearings

70 C

Contact angle $\alpha = 15^\circ$

70 AC

Contact angle $\alpha = 25^\circ$

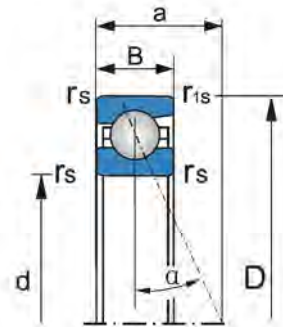

Bearing designations ZYS	Boundary dimensions						Load rating		Limiting speed		Weight kg ≈
	d	D	B	r _{smin}	r _{fsmin}	a	C _r	C _{or}	Grease	Oil	
	mm					≈	KN		r/min		
7013 C	65	100	18	1.10	0.60	20	38.9	42.9	13000	20000	0.42
7013 AC	65	100	18	1.10	0.60	28	36.8	40.7	11000	18000	0.42
7014 C	70	110	20	1.10	0.60	22	49.9	55.5	12000	19000	0.59
7014 AC	70	110	20	1.10	0.60	31	47.2	52.7	10000	17000	0.59
7015 C	75	115	20	1.10	0.60	23	51.3	59.2	11000	18000	0.62
7015 AC	75	115	20	1.10	0.60	32	48.5	56.2	9500	16000	0.62
7016 C	80	125	22	1.10	0.60	25	61.6	70.4	10000	17000	0.83
7016 AC	80	125	22	1.10	0.60	35	58.3	66.9	9000	15000	0.83
7017 C	85	130	22	1.10	0.60	25	63.3	75	9500	16000	0.87
7017 AC	85	130	22	1.10	0.60	36	59.9	71.3	8500	14000	0.87
7018 C	90	140	24	1.50	0.60	27	66.9	84	9000	15000	1.18
7018 AC	90	140	24	1.50	0.60	39	63.2	79.7	8000	13000	1.18
7019 C	95	145	24	1.50	0.60	28	79.1	97.6	8500	14000	1.20
7019 AC	95	145	24	1.50	0.60	40	74.8	92.7	7500	12000	1.20
7020 C	100	150	24	1.50	0.60	29	81.2	103.3	8000	13000	1.25
7020 AC	100	150	24	1.50	0.60	41	76.7	98	7000	11000	1.25
7021 C	105	160	26	2.00	1.00	31	93.9	118.2	7500	12000	1.58
7021 AC	105	160	26	2.00	1.00	44	88.8	112.2	7000	11000	1.58
7022 C	110	170	28	2.00	1.00	33	110.4	139.8	7000	11000	1.97
7022 AC	110	170	28	2.00	1.00	47	104.4	132.8	6700	10000	1.97
7024 C	120	180	28	2.00	1.00	34	112.7	148.7	7000	11000	2.11
7024 AC	120	180	28	2.00	1.00	49	106.5	141.1	6700	10000	2.11
7026 C	130	200	33	2.00	1.00	39	144.8	190.8	6700	10000	3.18
7026 AC	130	200	33	2.00	1.00	55	136.8	181.0	6000	9000	3.18
7028 C	140	210	33	2.00	1.00	40	148.7	202.6	6000	9000	3.37
7028 AC	140	210	33	2.00	1.00	57	140.4	192.2	5600	8500	3.37
7030 C	150	225	35	2.10	1.10	43	168.4	232.5	5600	8500	4.10
7030 AC	150	225	35	2.10	1.10	61	159.1	220.6	5000	7500	4.10

High-speed angular contact ball bearings

70 C

Contact angle $\alpha = 15^\circ$

70 AC

Contact angle $\alpha = 25^\circ$

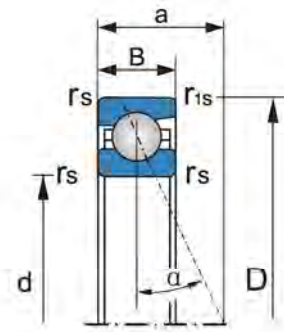

Bearing designations ZYS	Boundary dimensions						Load rating		Limiting speed		Weight kg ≈
	d	D	B	r _{smin}	r _{1smin}	a	C _r	C _{or}	Grease	Oil	
	mm						≈	KN		r/min	
7032 C	160	240	38	2.10	1.10	46	189.1	264.5	5000	7500	5.07
7032 AC	160	240	38	2.10	1.10	66	178.6	251.0	4800	7000	5.07
7034 C	170	260	42	2.10	1.10	50	205.6	299.3	4800	7000	6.90
7034 AC	170	260	42	2.10	1.10	71	194.2	284.0	4300	6300	6.90
7036 C	180	280	46	2.10	1.10	54	229.5	352.1	4500	6700	9.21
7036 AC	180	280	46	2.10	1.10	77	216.8	334.1	4000	6000	9.21
7038 C	190	290	46	2.10	1.10	55	235.1	370.8	4300	6300	9.61
7038 AC	190	290	46	2.10	1.10	79	222.1	351.8	3800	5600	9.61
7040 C	200	310	51	2.10	1.10	60	289.1	471.4	3800	5600	12.1
7040 AC	200	310	51	2.10	1.10	85	273.1	447.3	3600	5300	12.1
7044 C	220	340	56	3.00	1.10	66	325.3	559.4	3600	5300	15.9
7044 AC	220	340	56	3.00	1.10	93	307.3	530.8	3200	4800	15.9
7048 C	240	360	56	3.00	1.10	68	344.2	623.6	3200	4800	17.0
7048 AC	240	360	56	3.00	1.10	98	325.1	591.7	3000	4500	17.0

High-speed angular contact ball bearings

72 C

Contact angle $\alpha = 15^\circ$

72 AC

Contact angle $\alpha = 25^\circ$

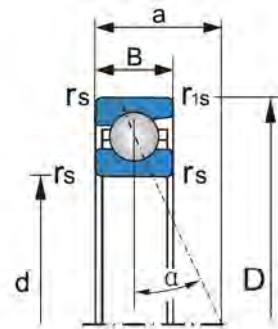

Bearing designations ZYS	Boundary dimensions						Load rating		Limiting speed		Weight kg ≈
	d	D	B	r _{smin}	r _{smin}	a	C _r	C _{or}	Grease	Oil	
	mm						≈	KN		r/min	
728 C	8	24	8	0.30	0.15	6	4.5	2.3	67000	100000	0.02
728 AC	8	24	8	0.30	0.15	8	4.4	2.2	60000	90000	0.02
7200 C	10	30	9	0.60	0.15	7	6.5	3.8	56000	85000	0.03
7200 AC	10	30	9	0.60	0.15	9	6.3	3.7	53000	80000	0.03
7201 C	12	32	10	0.60	0.15	8	7.2	4.5	53000	80000	0.04
7201 AC	12	32	10	0.60	0.15	10	6.9	4.3	48000	70000	0.04
7202 C	15	35	11	0.60	0.15	9	9.1	5.8	48000	70000	0.05
7202 AC	15	35	11	0.60	0.15	11	8.8	5.6	43000	63000	0.05
7203 C	17	40	12	0.60	0.30	10	11.3	7.4	40000	60000	0.07
7203 AC	17	40	12	0.60	0.30	13	10.9	7.1	38000	56000	0.07
7204 C	20	47	14	1.00	0.30	12	13.1	9.6	34000	50000	0.11
7204 AC	20	47	14	1.00	0.30	15	12.6	9.2	30000	45000	0.11
7205 C	25	52	15	1.00	0.30	13	16.8	13.1	30000	45000	0.14
7205 AC	25	52	15	1.00	0.30	16	16.1	12.5	26000	40000	0.14
7206 C	30	62	16	1.00	0.30	14	23.4	18.8	24000	38000	0.21
7206 AC	30	62	16	1.00	0.30	19	22.3	18.0	20000	34000	0.21
7207 C	35	72	17	1.10	0.60	16	25.8	22.9	18000	30000	0.31
7207 AC	35	72	17	1.10	0.60	21	24.5	21.9	17000	28000	0.31
7208 C	40	80	18	1.10	0.60	17	34.1	30.9	17000	28000	0.40
7208 AC	40	80	18	1.10	0.60	23	32.5	29.5	15000	24000	0.40
7209 C	45	85	19	1.10	0.60	18	35.5	33.8	16000	26000	0.45
7209 AC	45	85	19	1.10	0.60	25	33.8	32.3	14000	22000	0.45
7210 C	50	90	20	1.10	0.60	19	43.3	40.6	15000	24000	0.49
7210 AC	50	90	20	1.10	0.60	26	41.3	38.7	14000	22000	0.49
7211 C	55	100	21	1.50	0.60	21	53.6	51.1	14000	22000	0.65
7211 AC	55	100	21	1.50	0.60	29	51.1	48.8	13000	20000	0.65
7212 C	60	110	22	1.50	0.60	22	55.8	56.2	12000	19000	0.86
7212 AC	60	110	22	1.50	0.60	31	53.0	53.5	11000	18000	0.86

High-speed angular contact ball bearings

72 C

Contact angle $\alpha = 15^\circ$

72 AC

Contact angle $\alpha = 25^\circ$

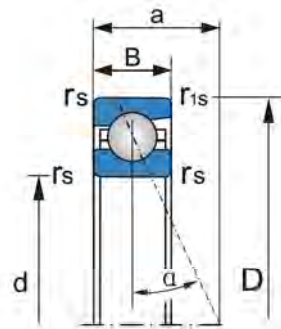

Bearing designations ZYS	Boundary dimensions						Load rating		Limiting speed		Weight kg ≈
	d	D	B	r _{smin}	r _{smin}	a	C _r	C _{or}	Grease	Oil	
	mm					≈	KN		r/min		
7213 C	65	120	23	1.50	0.60	24	67.5	69.0	11000	18000	1.08
7213 AC	65	120	23	1.50	0.60	33	64.2	65.8	9500	16000	1.08
7214 C	70	125	24	1.50	0.60	25	70.2	74.6	10000	17000	1.19
7214 AC	70	125	24	1.50	0.60	35	66.6	71.1	9000	15000	1.19
7215 C	75	130	25	1.50	0.60	26	72.7	80.2	9500	16000	1.29
7215 AC	75	130	25	1.50	0.60	36	68.9	76.3	8500	14000	1.29
7216 C	80	140	26	2.00	1.00	28	86.5	96.5	9000	15000	1.58
7216 AC	80	140	26	2.00	1.00	39	82.1	91.9	8000	13000	1.58
7217 C	85	150	28	2.00	1.00	30	97.4	107.5	8500	14000	1.96
7217 AC	85	150	28	2.00	1.00	42	92.5	102.4	7500	12000	1.96
7218 C	90	160	30	2.00	1.00	32	121.9	131.3	8000	13000	2.44
7218 AC	90	160	30	2.00	1.00	44	115.8	124.6	7000	11000	2.44
7219 C	95	170	32	2.10	1.10	34	128.9	145.1	7500	12000	2.93
7219 AC	95	170	32	2.10	1.10	47	122.5	138.3	6700	10000	2.93
7220 C	100	180	34	2.10	1.10	36	146.2	165.9	7000	11000	3.51
7220 AC	100	180	34	2.10	1.10	50	138.9	158.2	6700	10000	3.51
7221 C	105	190	36	2.10	1.10	38	164.3	188.2	7000	11000	4.17
7221 AC	105	190	36	2.10	1.10	52	156.3	179.5	6300	9500	4.17
7222 C	110	200	38	2.10	1.10	40	170.4	202.5	6700	10000	4.95
7222 AC	110	200	38	2.10	1.10	55	161.8	193.0	6000	9000	4.95
7224 C	120	215	40	2.10	1.10	42	175.4	218.4	6000	9000	6.01
7224 AC	120	215	40	2.10	1.10	59	166.3	207.9	5300	8000	6.01
7226 C	130	230	40	3.00	1.10	44	200.6	258.3	5600	8500	6.41
7226 AC	130	230	40	3.00	1.10	62	190.4	246.2	5000	7500	6.41
7228 C	140	250	42	3.00	1.10	47	223.6	306.6	5000	7500	8.17
7228 AC	140	250	42	3.00	1.10	66	212.3	292.2	4500	6700	8.17
7230 C	150	270	45	3.00	1.10	51	240.9	341.5	4500	6700	10.38
7230 AC	150	270	45	3.00	1.10	71	228.7	325.5	4000	6000	10.38

High-speed angular contact ball bearings

72 C

Contact angle $\alpha = 15^\circ$

72 AC

Contact angle $\alpha = 25^\circ$

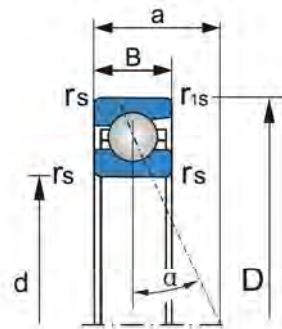

Bearing designations ZYS	Boundary dimensions						Load rating		Limiting speed		Weight kg ≈
	d	D	B	r _{smin}	r _{1smin}	a	C _r	C _{or}	Grease	Oil	
	mm						≈	KN		r/min	
7232 C	160	290	48	3.00	1.10	54	248.6	365.8	4300	6300	13.10
7232 AC	160	290	48	3.00	1.10	76	236.1	348.6	3800	5600	13.10
7234 C	170	310	52	4.00	1.50	58	300.2	459.2	3800	5600	15.93
7234 AC	170	310	52	4.00	1.50	82	285.0	437.6	3600	5300	15.93
7236 C	180	320	52	4.00	1.50	59	311.2	490.8	3800	5600	16.61
7236 AC	180	320	52	4.00	1.50	84	295.5	467.7	3400	5000	16.61
7238 C	190	340	55	4.00	1.50	63	321.3	524.8	3400	5000	20.29
7238 AC	190	340	55	4.00	1.50	89	305.1	500.1	3200	4800	20.29
7240 C	200	360	58	4.00	1.50	67	330.9	558.6	3200	4800	24.49
7240 AC	200	360	58	4.00	1.50	94	314.2	532.3	3000	4500	24.49
7244 C	220	400	65	4.00	1.50	74	405.9	730.5	2800	4300	33.93
7244 AC	220	400	65	4.00	1.50	105	385.4	696.2	2600	4000	33.93

super-speed angular contact ball bearings

H719 C

Contact angle $\alpha = 15^\circ$

H719 AC

Contact angle $\alpha = 25^\circ$

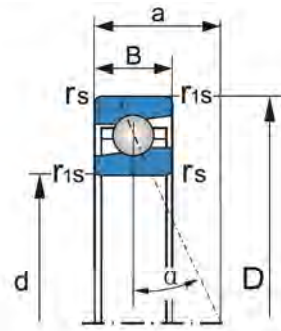

Bearing designations ZYS	Boundary dimensions						Load rating		Limiting speed		Weight kg ≈
	d	D	B	r _{smin}	r _{1smin}	a	C _r	C _{or}	Grease	Oil	
	mm					≈	KN		r/min		
H719/8 C	8	19	6	0.30	0.10	5	1.7	0.7	100000	170000	0.01
H719/8 AC	8	19	6	0.30	0.10	6	1.6	0.6	85000	140000	0.01
H71900 C	10	22	6	0.30	0.10	5	2.1	0.9	85000	140000	0.01
H71900 AC	10	22	6	0.30	0.10	7	2.0	0.9	75000	120000	0.01
H71901 C	12	24	6	0.30	0.10	5	2.2	1.1	80000	130000	0.01
H71901 AC	12	24	6	0.30	0.10	7	2.1	1.1	70000	110000	0.01
H71902 C	15	28	7	0.30	0.10	6	3.2	1.7	70000	110000	0.01
H71902 AC	15	28	7	0.30	0.10	9	3.1	1.6	60000	90000	0.01
H71903 C	17	30	7	0.30	0.10	7	3.3	1.8	67000	100000	0.02
H71903 AC	17	30	7	0.30	0.10	9	3.2	1.7	56000	85000	0.02
H71904 C	20	37	9	0.30	0.15	8	5.0	2.9	53000	80000	0.04
H71904 AC	20	37	9	0.30	0.15	11	4.8	2.7	45000	67000	0.04
H71905 C	25	42	9	0.30	0.15	9	5.2	3.4	48000	70000	0.04
H71905 AC	25	42	9	0.30	0.15	12	4.9	3.3	40000	60000	0.04
H71906 C	30	47	9	0.30	0.15	10	5.8	3.8	43000	63000	0.05
H71906 AC	30	47	9	0.30	0.15	13	5.4	3.6	36000	53000	0.05
H71907 C	35	55	10	0.60	0.15	11	7.7	5.4	36000	53000	0.07
H71907 AC	35	55	10	0.60	0.15	16	7.4	5.1	30000	45000	0.07
H71908 C	40	62	12	0.60	0.15	13	9.8	7.0	30000	45000	0.12
H71908 AC	40	62	12	0.60	0.15	18	9.3	6.6	26000	40000	0.12
H71909 C	45	68	12	0.60	0.15	14	10.3	7.7	26000	40000	0.14
H71909 AC	45	68	12	0.60	0.15	19	9.7	7.3	22000	36000	0.14
H71910 C	50	72	12	0.60	0.15	14	13.2	10.0	22000	36000	0.14
H71910 AC	50	72	12	0.60	0.15	20	12.5	9.5	19000	32000	0.14
H71911 C	55	80	13	1.00	0.30	16	16.0	12.6	19000	32000	0.18
H71911 AC	55	80	13	1.00	0.30	22	15.0	11.9	16000	26000	0.18
H71912 C	60	85	13	1.00	0.30	16	16.6	13.8	18000	30000	0.20
H71912 AC	60	85	13	1.00	0.30	23	15.7	13.1	15000	24000	0.20

super-speed angular contact ball bearings
H719 C
Contact angle $\alpha = 15^\circ$
H719 AC
Contact angle $\alpha = 25^\circ$

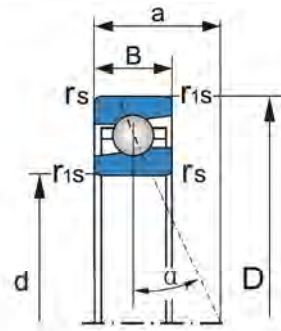

Bearing designations ZYS	Boundary dimensions						Load rating		Limiting speed		Weight kg ≈
	d	D	B	r _{smin}	r _{1smin}	a	C _r	C _{0r}	Grease	Oil	
	mm					≈	KN		r/min		
H71913 C	65	90	13	1.00	0.30	17	16.8	14.5	17000	28000	0.21
H71913 AC	65	90	13	1.00	0.30	25	16.0	13.7	15000	24000	0.21
H71914 C	70	100	16	1.00	0.30	19	20.9	17.8	16000	26000	0.35
H71914 AC	70	100	16	1.00	0.30	28	19.7	16.9	13000	20000	0.35
H71915 C	75	105	16	1.00	0.30	20	21.7	19.3	15000	24000	0.37
H71915 AC	75	105	16	1.00	0.30	29	20.5	18.2	13000	20000	0.37
H71916 C	80	110	16	1.00	0.30	21	22.4	20.8	14000	22000	0.39
H71916 AC	80	110	16	1.00	0.30	30	21.2	19.6	12000	19000	0.39
H71917 C	85	120	18	1.10	0.60	23	26.1	24.2	13000	20000	0.56
H71917 AC	85	120	18	1.10	0.60	23	24.7	22.9	11000	18000	0.56
H71918 C	90	125	18	1.10	0.60	23	27.0	26.0	13000	20000	0.59
H71918 AC	90	125	18	1.10	0.60	34	25.5	24.6	11000	18000	0.59
H71919 C	95	130	18	1.10	0.60	24	27.3	26.9	12000	19000	0.62
H71919 AC	95	130	18	1.10	0.60	35	25.8	25.4	11000	18000	0.62
H71920 C	100	140	20	1.10	0.60	26	40.1	37.6	11000	18000	0.82
H71920 AC	100	140	20	1.10	0.60	38	37.9	35.5	9000	15000	0.82
H71921 C	105	145	20	1.10	0.60	27	40.7	39.1	10000	17000	0.85
H71921 AC	105	145	20	1.10	0.60	39	38.4	36.9	8500	14000	0.85
H71922 C	110	150	20	1.10	0.60	27	41.3	40.5	9000	15000	0.89
H71922 AC	110	150	20	1.10	0.60	40	39.0	38.3	7500	12000	0.89
H71924 C	120	165	22	1.10	0.60	30	43.1	44.9	8500	14000	1.25
H71924 AC	120	165	22	1.10	0.60	44	40.7	42.4	7500	12000	1.25
H71926 C	130	180	24	1.50	0.60	33	53.1	56.6	8000	13000	1.58
H71926 AC	130	180	24	1.50	0.60	48	50.1	53.4	7500	12000	1.58
H71928 C	140	190	24	1.50	0.60	34	53.7	59.1	7000	11000	1.67
H71928 AC	140	190	24	1.50	0.60	50	50.7	55.8	6700	10000	1.67
H71930 C	150	210	28	2.00	1.00	38	65.2	72.8	6700	10000	2.64
H71930 AC	150	210	28	2.00	1.00	56	61.5	68.7	6000	9000	2.64

super-speed angular contact ball bearings

H719 C

Contact angle $\alpha = 15^\circ$

H719 AC

Contact angle $\alpha = 25^\circ$

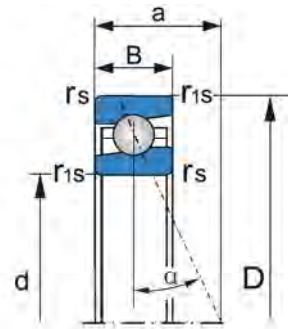

Bearing designations ZYS	Boundary dimensions						Load rating		Limiting speed		Weight kg ≈
	d	D	B	r _{smin}	r _{1smin}	a	C _r	C _{or}	Grease	Oil	
	mm					≈	KN		r/min		
H71932 C	160	220	28	2.00	1.00	39	66.0	75.8	6000	9000	2.78
H71932 AC	160	220	28	2.00	1.00	58	62.3	71.6	5600	8500	2.78
H71934 C	170	230	28	2.00	1.00	41	66.7	78.7	5600	8500	2.92
H71934 AC	170	230	28	2.00	1.00	61	63.0	74.3	5000	7500	2.92
H71936 C	180	250	33	2.00	1.00	45	79.6	95.0	5000	7500	4.42
H71936 AC	180	250	33	2.00	1.00	67	75.2	89.7	4800	7000	4.42
H71938 C	190	260	33	2.00	1.00	47	80.6	98.6	4800	7000	4.62
H71938 AC	190	260	33	2.00	1.00	69	76.1	93.1	4300	6300	4.62
H71940 C	200	280	38	2.00	1.00	51	82.8	105.4	4500	6700	6.74
H71940 AC	200	280	38	2.00	1.00	75	78.2	99.5	4000	6000	6.74
H71944 C	220	300	38	2.00	1.00	54	96.9	125.4	4300	6300	7.12
H71944 AC	220	300	38	2.00	1.00	80	91.5	118.4	3800	5600	7.12

Super-speed angular contact ball bearings
H70 C
Contact angle $\alpha = 15^\circ$
H70 AC
Contact angle $\alpha = 25^\circ$

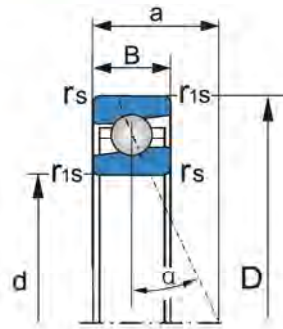

Bearing designations ZYS	Boundary dimensions						Load rating		Limiting speed		Weight kg ≈
	d	D	B	r _{smin}	r _{ismin}	a	C _r	C _{or}	Grease	Oil	
	mm					≈	KN		r/min		
H708 C	8	22	7	0.30	0.15	5.5	2.4	1.0	90000	150000	0.01
H708 AC	8	22	7	0.30	0.15	7	2.3	0.9	80000	130000	0.01
H7000 C	10	26	8	0.30	0.15	6	3.4	1.5	80000	130000	0.02
H7000 AC	10	26	8	0.30	0.15	8	3.3	1.4	67000	110000	0.02
H7001 C	12	28	8	0.30	0.15	7	3.8	1.7	70000	110000	0.02
H7001 AC	12	28	8	0.30	0.15	9	3.6	1.6	60000	90000	0.02
H7002 C	15	32	9	0.30	0.15	8	4.4	2.2	67000	100000	0.03
H7002 AC	15	32	9	0.30	0.15	10	4.2	2.1	56000	85000	0.03
H7003 C	17	35	10	0.30	0.15	8	5.2	2.5	56000	85000	0.04
H7003 AC	17	35	10	0.30	0.15	11	5.0	2.4	50000	75000	0.04
H7004 C	20	42	12	0.60	0.15	10	7.4	3.9	50000	75000	0.07
H7004 AC	20	42	12	0.60	0.15	13	7.0	3.8	43000	63000	0.07
H7005 C	25	47	12	0.60	0.15	11	8.4	4.8	43000	63000	0.08
H7005 AC	25	47	12	0.60	0.15	14	8.0	4.6	36000	53000	0.08
H7006 C	30	55	13	1.00	0.30	12	9.5	6.2	38000	56000	0.11
H7006 AC	30	55	13	1.00	0.30	17	9.0	5.9	34000	50000	0.11
H7007 C	35	62	14	1.00	0.30	13	11.2	7.9	34000	50000	0.15
H7007 AC	35	62	14	1.00	0.30	18	10.7	7.5	30000	45000	0.15
H7008 C	40	68	15	1.00	0.30	15	12.5	9.1	28000	43000	0.19
H7008 AC	40	68	15	1.00	0.30	20	11.1	8.6	24000	38000	0.19
H7009 C	45	75	16	1.00	0.30	16	13.1	10.2	24000	38000	0.24
H7009 AC	45	75	16	1.00	0.30	22	12.5	9.7	22000	36000	0.24
H7010 C	50	80	16	1.00	0.30	17	15.4	12.0	20000	34000	0.26
H7010 AC	50	80	16	1.00	0.30	23	14.7	11.4	18000	30000	0.26
H7011 C	55	90	18	1.10	0.60	19	17.0	14.5	19000	32000	0.41
H7011 AC	55	90	18	1.10	0.60	26	16.0	13.7	17000	28000	0.41
H7012 C	60	95	18	1.10	0.60	19	17.0	15.3	18000	30000	0.44
H7012 AC	60	95	18	1.10	0.60	27	16.2	14.4	15000	24000	0.44

Super-speed angular contact ball bearings
H70 C
Contact angle $\alpha = 15^\circ$
H70 AC
Contact angle $\alpha = 25^\circ$

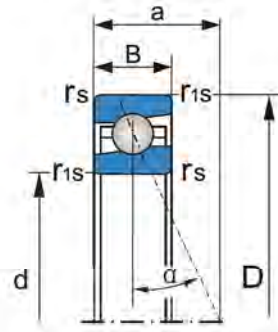

Bearing designations ZYS	Boundary dimensions						Load rating		Limiting speed		Weight kg ≈
	d	D	B	r _{smin}	r _{1smin}	a	C _r	C _{or}	Grease	Oil	
	mm						≈	KN		r/min	
H7013 C	65	100	18	1.10	0.60	20	20.2	18.6	16000	26000	0.45
H7013 AC	65	100	18	1.10	0.60	28	19.0	17.6	13000	20000	0.45
H7014 C	70	110	20	1.10	0.60	22	24.1	21.4	15000	24000	0.64
H7014 AC	70	110	20	1.10	0.60	31	22.6	20.1	13000	20000	0.64
H7015 C	75	115	20	1.10	0.60	23	26.2	25.5	14000	22000	0.68
H7015 AC	75	115	20	1.10	0.60	32	24.7	24.2	12000	19000	0.68
H7016 C	80	125	22	1.10	0.60	25	34.2	32.7	13000	20000	0.90
H7016 AC	80	125	22	1.10	0.60	35	32.3	31.0	11000	18000	0.90
H7017 C	85	130	22	1.10	0.60	25	35.0	35.2	12000	19000	0.95
H7017 AC	85	130	22	1.10	0.60	36	33.0	33.4	10000	17000	0.95
H7018 C	90	140	24	1.50	0.60	27	36.4	38.1	11000	18000	1.26
H7018 AC	90	140	24	1.50	0.60	39	34.3	36.1	9500	16000	1.26
H7019 C	95	145	24	1.50	0.60	28	44.4	45.2	10000	17000	1.27
H7019 AC	95	145	24	1.50	0.60	40	41.9	42.9	8500	14000	1.27
H7020 C	100	150	24	1.50	0.60	29	45.4	48.1	10000	17000	1.33
H7020 AC	100	150	24	1.50	1.00	41	42.7	44.7	8500	14000	1.33
H7021 C	105	160	26	2.00	1.00	31	46.1	49.2	9500	16000	1.72
H7021 AC	105	160	26	2.00	1.00	44	43.3	46.6	8000	13000	1.72
H7022 C	110	170	28	2.00	1.00	33	47.9	53.9	9500	16000	2.20
H7022 AC	110	170	28	2.00	1.00	47	45.1	51.1	8000	13000	2.20
H7024 C	120	180	28	2.00	1.00	34	58.3	64.9	8500	14000	2.30
H7024 AC	120	180	28	2.00	1.00	49	54.8	61.5	7500	12000	2.30
H7026 C	130	200	33	2.00	1.00	39	58.6	66.8	8000	13000	3.59
H7026 AC	130	200	33	2.00	1.00	55	55.1	63.2	7000	11000	3.59
H7028 C	140	210	33	2.00	1.00	40	60.7	72.5	7500	12000	3.81
H7028 AC	140	210	33	2.00	1.00	57	57.1	68.7	6700	10000	3.81
H7030 C	150	225	35	2.10	1.10	43	74.9	88.5	6700	10000	4.61
H7030 AC	150	225	35	2.10	1.10	61	70.5	83.8	6300	9500	4.61

Super-speed angular contact ball bearings
H70 C
Contact angle $\alpha = 15^\circ$
H70 AC
Contact angle $\alpha = 25^\circ$

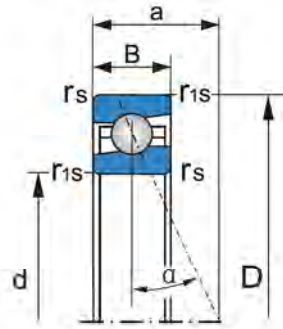

Bearing designations ZYS	Boundary dimensions						Load rating		Limiting speed		Weight kg ≈
	d	D	B	r _{smin}	r _{1smin}	a	C _r	C _{or}	Grease	Oil	
	mm						≈	KN		r/min	
H7032 C	160	240	38	2.10	1.10	46	76.2	94.5	6000	9000	5.78
H7032 AC	160	240	38	2.10	1.10	66	71.6	89.5	5600	8500	5.78
H7034 C	170	260	42	2.10	1.10	50	78.1	100.6	5600	8500	7.94
H7034 AC	170	260	42	2.10	1.10	71	73.4	95.2	5000	7500	7.94
H7036 C	180	280	46	2.10	1.10	54	79.8	106.7	5300	8000	10.57
H7036 AC	180	280	46	2.10	1.10	77	75.0	101.0	4800	7000	10.57
H7038 C	190	290	46	2.10	1.10	55	95.3	124.6	4800	7000	10.84
H7038 AC	190	290	46	2.10	1.10	79	89.7	117.9	4300	6300	10.84
H7040 C	200	310	51	2.10	1.10	60	96.5	132.0	4500	6700	14.32
H7040 AC	200	310	51	2.10	1.10	85	90.8	124.9	4000	6000	14.32
H7044 C	220	340	56	3.00	1.10	66	113.9	156.5	4000	6000	18.82
H7044 AC	220	340	56	3.00	1.10	93	107.2	148.1	3800	5600	18.82

Super-speed angular contact ball bearings(ceramic balls)

H719 C/HQ1

Contact angle $\alpha = 15^\circ$

H719 AC/HQ1

Contact angle $\alpha = 25^\circ$

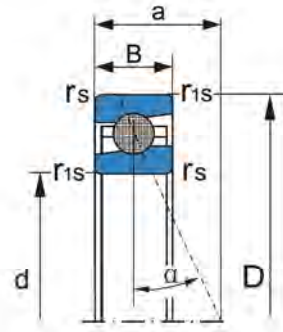

Bearing designations ZYS	Boundary dimensions						Load rating		Limiting speed		Weight kg ≈
	d	D	B	r _{smin}	r _{1smin}	a	C _r	C _{or}	Grease	Oil	
	mm						≈	KN		r/min	
H719/8 C/HQ1	8	19	6	0.30	0.10	5	1.7	0.7	110000	180000	0.01
H719/8 AC/HQ1	8	19	6	0.30	0.10	6	1.6	0.6	95000	160000	0.01
H71900 C/HQ1	10	22	6	0.30	0.10	5	2.1	0.9	95000	160000	0.01
H71900 AC/HQ1	10	22	6	0.30	0.10	7	2.0	0.9	85000	140000	0.01
H71901 C/HQ1	12	24	6	0.30	0.10	5	2.2	1.1	90000	150000	0.01
H71901 AC/HQ1	12	24	6	0.30	0.10	7	2.1	1.1	80000	130000	0.01
H71902 C/HQ1	15	28	7	0.30	0.10	6	3.2	1.7	80000	130000	0.01
H71902 AC/HQ1	15	28	7	0.30	0.10	9	3.1	1.6	70000	110000	0.01
H71903 C/HQ1	17	30	7	0.30	0.10	7	3.3	1.8	75000	120000	0.01
H71903 AC/HQ1	17	30	7	0.30	0.10	9	3.2	1.7	63000	95000	0.01
H71904 C/HQ1	20	37	9	0.30	0.15	8	5.0	2.9	63000	95000	0.03
H71904 AC/HQ1	20	37	9	0.30	0.15	11	4.8	2.7	53000	80000	0.03
H71905 C/HQ1	25	42	9	0.30	0.15	9	5.2	3.4	53000	80000	0.04
H71905 AC/HQ1	25	42	9	0.30	0.15	12	4.9	3.3	45000	67000	0.04
H71906 C/HQ1	30	47	9	0.30	0.15	10	5.8	3.8	48000	70000	0.04
H71906 AC/HQ1	30	47	9	0.30	0.15	13	5.4	3.6	40000	60000	0.04
H71907 C/HQ1	35	55	10	0.60	0.15	11	7.7	5.4	40000	60000	0.07
H71907 AC/HQ1	35	55	10	0.60	0.15	16	7.4	5.1	34000	50000	0.07
H71908 C/HQ1	40	62	12	0.60	0.15	13	9.8	7.0	34000	50000	0.10
H71908 AC/HQ1	40	62	12	0.60	0.15	18	9.3	6.6	28000	43000	0.10
H71909 C/HQ1	45	68	12	0.60	0.15	14	10.3	7.7	28000	43000	0.12
H71909 AC/HQ1	45	68	12	0.60	0.15	19	9.7	7.3	26000	40000	0.12
H71910 C/HQ1	50	72	12	0.60	0.15	14	13.2	10.0	26000	40000	0.12
H71910 AC/HQ1	50	72	12	0.60	0.15	20	12.5	9.5	22000	36000	0.12
H71911 C/HQ1	55	80	13	1.00	0.30	16	16.0	12.6	22000	36000	0.15
H71911 AC/HQ1	55	80	13	1.00	0.30	22	15.0	11.9	19000	32000	0.15
H71912 C/HQ1	60	85	13	1.00	0.30	23	16.6	13.8	20000	34000	0.16
H71912 AC/HQ1	60	85	13	1.00	0.30	23	15.7	13.1	18000	30000	0.16

Super-speed angular contact ball bearings(ceramic balls)

H719 C/HQ1

Contact angle $\alpha = 15^\circ$

H719 AC/HQ1

Contact angle $\alpha = 25^\circ$

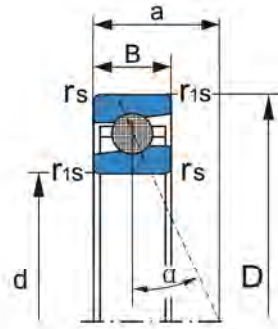

Bearing designations ZYS	Boundary dimensions						Load rating		Limiting speed		Weight kg ≈
	d	D	B	r _{smin}	r _{1smin}	a	C _r	C _{or}	Grease	Oil	
	mm						≈	KN		r/min	
H71913 C/HQ1	65	90	13	1.00	0.30	17	16.8	14.5	19000	32000	0.17
H71913 AC/HQ1	65	90	13	1.00	0.30	25	16.0	13.7	17000	28000	0.17
H71914 C/HQ1	70	100	16	1.00	0.30	19	20.9	17.8	18000	30000	0.28
H71914 AC/HQ1	70	100	16	1.00	0.30	28	19.7	16.9	15000	24000	0.28
H71915 C/HQ1	75	105	16	1.00	0.30	20	21.7	19.3	17000	28000	0.30
H71915 AC/HQ1	75	105	16	1.00	0.30	29	20.5	18.2	15000	24000	0.30
H71916 C/HQ1	80	110	16	1.00	0.30	21	22.4	20.8	16000	26000	0.31
H71916 AC/HQ1	80	110	16	1.00	0.30	30	21.2	19.6	14000	22000	0.31
H71917 C/HQ1	85	120	18	1.00	0.30	23	26.1	24.2	15000	24000	0.44
H71917 AC/HQ1	85	120	18	1.10	0.60	33	24.7	22.9	13000	20000	0.44
H71918 C/HQ1	90	125	18	1.10	0.60	23	27.0	26.0	15000	24000	0.46
H71918 AC/HQ1	90	125	18	1.10	0.60	34	25.5	24.6	13000	20000	0.46
H71919 C/HQ1	95	130	18	1.10	0.60	24	27.3	26.9	14000	22000	0.48
H71919 AC/HQ1	95	130	18	1.10	0.60	35	25.8	25.4	13000	20000	0.48
H71920 C/HQ1	100	140	20	1.10	0.60	26	40.1	37.6	13000	20000	0.66
H71920 AC/HQ1	100	140	20	1.10	0.60	38	37.9	35.5	11000	18000	0.66
H71921 C/HQ1	105	145	20	1.10	0.60	27	40.7	39.1	12000	19000	0.69
H71921 AC/HQ1	105	145	20	1.10	0.60	39	38.4	36.9	10000	17000	0.69
H71922 C/HQ1	110	150	20	1.10	0.60	27	41.3	40.5	11000	18000	0.71
H71922 AC/HQ1	110	150	20	1.10	0.60	40	39.0	38.3	9500	16000	0.71
H71924 C/HQ1	120	165	22	1.10	0.60	30	43.1	44.9	10000	17000	0.97
H71924 AC/HQ1	120	165	22	1.10	0.60	44	40.7	42.4	9000	15000	0.97
H71926 C/HQ1	130	180	24	1.50	0.60	33	53.1	56.6	9000	15000	1.38
H71926 AC/HQ1	130	180	24	1.50	0.60	48	50.1	53.4	8500	14000	1.38
H71928 C/HQ1	140	190	24	1.50	0.60	34	53.7	59.1	8000	13000	1.46
H71928 AC/HQ1	140	190	24	1.50	0.60	50	50.7	55.8	7500	12000	1.46
H71930 C/HQ1	150	210	28	2.00	1.00	38	65.2	72.8	7500	12000	2.35
H71930 AC/HQ1	150	210	28	2.00	1.00	56	61.5	68.7	7000	11000	2.35

Super-speed angular contact ball bearings(ceramic balls)
H719 C/HQ1
Contact angle $\alpha = 15^\circ$
H719 AC/HQ1
Contact angle $\alpha = 25^\circ$

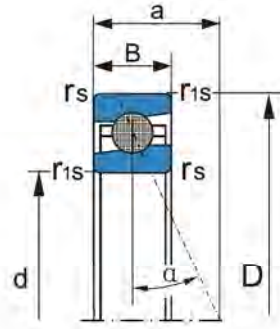

Bearing designations ZYS	Boundary dimensions						Load rating		Limiting speed		Weight kg ≈
	d	D	B	r _{smin}	r _{1smin}	a	C _r	C _{or}	Grease	Oil	
	mm						≈	KN		r/min	
H71932 C/HQ1	160	220	28	2.00	1.00	39	66.0	75.8	7000	11000	2.48
H71932 AC/HQ1	160	220	28	2.00	1.00	58	62.3	71.6	6700	10000	2.48
H71934 C/HQ1	170	230	28	2.00	1.00	41	66.7	78.7	6700	10000	2.61
H71934 AC/HQ1	170	230	28	2.00	1.00	61	63.0	74.3	6000	9000	2.61
H71936 C/HQ1	180	250	33	2.00	1.00	45	79.6	95.0	6000	9000	4.01
H71936 AC/HQ1	180	250	33	2.00	1.00	67	75.2	89.7	5600	8500	4.01
H71938 C/HQ1	190	260	33	2.00	1.00	47	80.6	98.6	5600	8500	4.20
H71938 AC/HQ1	190	260	33	2.00	1.00	69	76.1	93.1	5000	7500	4.20
H71940 C/HQ1	200	280	38	2.00	1.00	51	82.8	105.4	5000	7500	6.29
H71940 AC/HQ1	200	280	38	2.00	1.00	75	78.2	99.5	4500	6700	6.29
H71944 C/HQ1	220	300	38	2.00	1.00	54	96.9	125.4	5000	7500	6.54
H71944 AC/HQ1	220	300	38	2.00	1.00	80	91.5	118.4	4300	6300	6.54

Super-speed angular contact ball bearings(ceramic balls)

H70 C/HQ1

Contact angle $\alpha = 15^\circ$

H70 AC/HQ1

Contact angle $\alpha = 25^\circ$

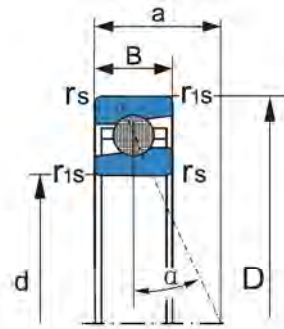

Bearing designations ZYS	Boundary dimensions						Load rating		Limiting speed		Weight kg ≈
	d	D	B	r _{smin}	r _{1smin}	a	C _r	C _{or}	Grease	Oil	
	mm					≈	KN		r/min		
H7000 C/HQ1	10	26	8	0.30	0.15	6	3.4	1.5	90000	150000	0.02
H7000 AC/HQ1	10	26	8	0.30	0.15	8	3.3	1.4	80000	130000	0.02
H7001 C/HQ1	12	28	8	0.30	0.15	7	3.8	1.7	80000	130000	0.02
H7001 AC/HQ1	12	28	8	0.30	0.15	9	3.6	1.6	70000	110000	0.02
H7002 C/HQ1	15	32	9	0.30	0.15	8	4.4	2.2	75000	120000	0.03
H7002 AC/HQ1	15	32	9	0.30	0.15	10	4.2	2.1	67000	100000	0.03
H7003 C/HQ1	17	35	10	0.30	0.15	8	5.2	2.5	63000	95000	0.04
H7003 AC/HQ1	17	35	10	0.30	0.15	11	5.0	2.4	60000	90000	0.04
H7004 C/HQ1	20	42	12	0.60	0.15	10	7.4	3.9	60000	90000	0.06
H7004 AC/HQ1	20	42	12	0.60	0.15	13	7.0	3.8	48000	70000	0.06
H7005 C/HQ1	25	47	12	0.60	0.15	11	8.4	4.8	48000	70000	0.07
H7005 AC/HQ1	25	47	12	0.60	0.15	14	8.0	4.6	43000	63000	0.07
H7006 C/HQ1	30	55	13	1.00	0.30	12	9.5	6.2	45000	67000	0.11
H7006 AC/HQ1	30	55	13	1.00	0.30	17	9.0	5.9	38000	56000	0.11
H7007 C/HQ1	35	62	14	1.00	0.30	13	11.2	7.9	38000	56000	0.14
H7007 AC/HQ1	35	62	14	1.00	0.30	18	10.7	7.5	34000	50000	0.14
H7008 C/HQ1	40	68	15	1.00	0.30	15	12.5	9.1	34000	50000	0.18
H7008 AC/HQ1	40	68	15	1.00	0.30	20	11.1	8.6	28000	43000	0.18
H7009 C/HQ1	45	75	16	1.00	0.30	16	13.1	10.2	28000	43000	0.24
H7009 AC/HQ1	45	75	16	1.00	0.30	22	12.5	9.7	26000	40000	0.24
H7010 C/HQ1	50	80	16	1.00	0.30	17	15.4	12.0	24000	38000	0.24
H7010 AC/HQ1	50	80	16	1.00	0.30	23	14.7	11.4	20000	34000	0.24
H7011 C/HQ1	55	90	18	1.00	0.30	19	17.0	14.5	22000	36000	0.38
H7011 AC/HQ1	55	90	18	1.00	0.30	26	16.0	13.7	19000	32000	0.38
H7012 C/HQ1	60	95	18	1.10	0.60	19	17.0	15.3	20000	34000	0.41
H7012 AC/HQ1	60	95	18	1.10	0.60	27	16.2	14.4	18000	30000	0.41
H7013 C/HQ1	65	100	18	1.10	0.60	20	20.2	18.6	19000	32000	0.42
H7013 AC/HQ1	65	100	18	1.10	0.60	28	19.0	17.6	15000	24000	0.42

Super-speed angular contact ball bearings(ceramic balls)

H70 C/HQ1

Contact angle $\alpha=15^\circ$

H70 AC/HQ1

Contact angle $\alpha=25^\circ$

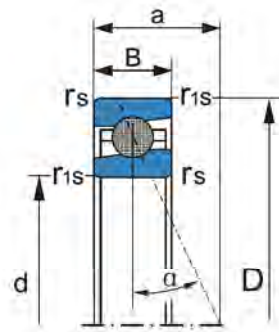

Bearing designations ZYS	Boundary dimensions						Load rating		Limiting speed		Weight kg ≈
	d	D	B	r _{smin}	r _{1smin}	a	C _r	C _{or}	Grease	Oil	
	mm					≈	KN		r/min		
H7014 C/HQ1	70	110	20	1.10	0.60	22	24.1	21.4	18000	30000	0.59
H7014 AC/HQ1	70	110	20	1.10	0.60	31	22.6	20.1	15000	24000	0.59
H7015 C/HQ1	75	115	20	1.10	0.60	23	26.2	25.5	16000	26000	0.63
H7015 AC/HQ1	75	115	20	1.10	0.60	32	24.7	24.2	14000	22000	0.63
H7016 C/HQ1	80	125	22	1.10	0.60	25	34.2	32.7	15000	24000	0.82
H7016 AC/HQ1	80	125	22	1.10	0.60	35	32.3	31.0	13000	20000	0.82
H7017 C/HQ1	85	130	22	1.10	0.60	25	35.0	35.2	14000	22000	0.86
H7017 AC/HQ1	85	130	22	1.10	0.60	36	33.0	33.4	12000	19000	0.86
H7018 C/HQ1	90	140	24	1.50	0.60	27	36.4	38.1	13000	20000	1.17
H7018 AC/HQ1	90	140	24	1.50	0.60	39	34.3	36.1	11000	18000	1.17
H7019 C/HQ1	95	145	24	1.50	0.60	28	44.4	45.2	12000	19000	1.18
H7019 AC/HQ1	95	145	24	1.50	0.60	40	41.9	42.9	10000	17000	1.18
H7020 C/HQ1	100	150	24	1.50	0.60	29	45.4	48.1	12000	19000	1.20
H7020 AC/HQ1	100	150	24	1.50	1.00	41	42.7	44.7	10000	17000	1.20
H7021 C/HQ1	105	160	26	2.00	1.00	31	46.1	49.2	11000	18000	1.58
H7021 AC/HQ1	105	160	26	2.00	1.00	44	43.3	46.6	9000	15000	1.58
H7022 C/HQ1	110	170	28	2.00	1.00	33	47.9	53.9	11000	18000	2.05
H7022 AC/HQ1	110	170	28	2.00	1.00	47	45.1	51.1	9000	15000	2.05
H7024 C/HQ1	120	180	28	2.00	1.00	34	58.3	64.9	10000	17000	2.07
H7024 AC/HQ1	120	180	28	2.00	1.00	49	54.8	61.5	9000	15000	2.07
H7026 C/HQ1	130	200	33	2.00	1.00	39	58.6	66.8	9000	15000	3.37
H7026 AC/HQ1	130	200	33	2.00	1.00	55	55.1	63.2	8000	13000	3.37
H7028 C/HQ1	140	210	33	2.00	1.00	40	60.7	72.5	8500	14000	3.57
H7028 AC/HQ1	140	210	33	2.00	1.00	57	57.1	68.7	7500	12000	3.57
H7030 C/HQ1	150	225	35	2.10	1.10	43	74.9	88.5	7500	12000	4.30
H7030 AC/HQ1	150	225	35	2.10	1.10	61	70.5	83.8	7000	11000	4.30
H7032 C/HQ1	160	240	38	2.10	1.10	46	76.2	94.5	6700	10000	5.45
H7032 AC/HQ1	160	240	38	2.10	1.10	66	71.6	89.5	6300	9500	5.45

Super-speed angular contact ball bearings (ceramic balls)
H70 C/HQ1
Contact angle $\alpha = 15^\circ$
H70 AC/HQ1
Contact angle $\alpha = 25^\circ$

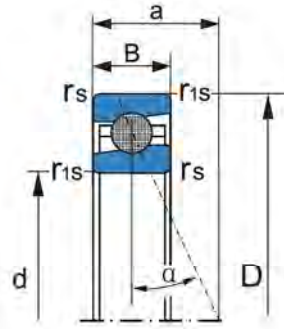

Bearing designations ZYS	Boundary dimensions						Load rating		Limiting speed		Weight kg ≈
	d	D	B	r _{smin}	r _{1smin}	a	C _r	C _{or}	Grease	Oil	
	mm						≈	KN		r/min	
H7034 C/HQ1	170	260	42	2.10	1.10	50	78.1	100.6	6300	9500	7.59
H7034 AC/HQ1	170	260	42	2.10	1.10	71	73.4	95.2	5600	8500	7.59
H7036 C/HQ1	180	280	46	2.10	1.10	54	79.8	106.7	6000	9000	10.20
H7036 AC/HQ1	180	280	46	2.10	1.10	77	75.0	101.0	5300	8000	10.20
H7038 C/HQ1	190	290	46	2.10	1.10	55	95.3	124.6	5300	8000	10.36
H7038 AC/HQ1	190	290	46	2.10	1.10	79	89.7	117.9	4800	7000	10.36
H7040 C/HQ1	200	310	51	2.10	1.10	60	96.5	132.0	5000	7500	13.81
H7040 AC/HQ1	200	310	51	2.10	1.10	85	90.8	124.9	4500	6700	13.81
H7044 C/HQ1	220	340	56	3.00	1.10	66	113.9	156.5	4500	6700	18.16
H7044 AC/HQ1	220	340	56	3.00	1.10	93	107.2	148.1	4000	6000	18.16

Super-speed angular contact ball bearings

HS719 C

Contact angle $\alpha = 15^\circ$

HS719 AC

Contact angle $\alpha = 25^\circ$

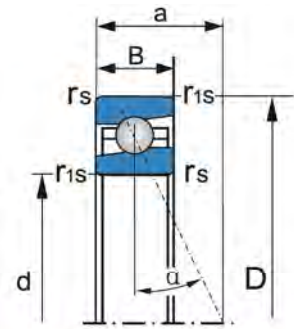

Bearing designations ZYS	Boundary dimensions						Load rating		Limiting speed		Weight kg ≈
	d	D	B	r _{smin}	r _{1smin}	a	C _r	C _{or}	Grease	Oil	
	mm						≈	KN		r/min	
HS71900C	10	22	6	0.30	0.10	5	1.9	1.0	90000	150000	0.01
HS71900AC	10	22	6	0.30	0.10	7	1.8	1.0	80000	130000	0.01
HS71901C	12	24	6	0.30	0.10	5	2.0	1.1	85000	140000	0.01
HS71901AC	12	24	6	0.30	0.10	7	1.9	1.1	75000	120000	0.01
HS71902C	15	28	7	0.30	0.10	6	2.2	1.4	75000	120000	0.02
HS71902AC	15	28	7	0.30	0.10	9	2.1	1.3	63000	95000	0.02
HS71903C	17	30	7	0.30	0.10	7	2.3	1.5	70000	110000	0.02
HS71903AC	17	30	7	0.30	0.10	9	2.2	1.4	58000	90000	0.02
HS71904C	20	37	9	0.30	0.15	8	3.9	2.7	56000	84000	0.04
HS71904AC	20	37	9	0.30	0.15	11	3.7	2.5	48000	70000	0.04
HS71905C	25	42	9	0.30	0.15	9	4.2	3.2	50000	75000	0.05
HS71905AC	25	42	9	0.30	0.15	12	3.9	3.0	45000	63000	0.05
HS71906C	30	47	9	0.30	0.15	10	6.3	4.9	45000	67000	0.05
HS71906AC	30	47	9	0.30	0.15	13	6.0	4.6	38000	56000	0.05
HS71907C	35	55	10	0.60	0.15	11	6.9	6.0	38000	56000	0.08
HS71907AC	35	55	10	0.60	0.15	15	6.5	5.6	32000	48000	0.08
HS71908C	40	62	12	0.60	0.15	13	7.2	6.8	32000	48000	0.13
HS71908AC	40	62	12	0.60	0.15	18	6.8	6.4	28000	43000	0.13
HS71909C	45	68	12	0.60	0.15	14	10.0	9.3	28000	43000	0.15
HS71909AC	45	68	12	0.60	0.15	19	9.4	8.8	24000	38000	0.15
HS71910C	50	72	12	0.60	0.15	14	10.3	10.1	24000	38000	0.15
HS71910AC	50	72	12	0.60	0.15	20	9.7	9.5	20000	34000	0.15
HS71911C	55	80	13	0.60	0.30	16	13.2	12.9	20000	34000	0.20
HS71911AC	55	80	13	1.0	0.30	22	12.4	12.2	17000	28000	0.20
HS71912C	60	85	13	1.0	0.30	16	13.6	13.9	19000	32000	0.22
HS71912AC	60	85	13	1.0	0.30	23	12.8	13.2	16000	26000	0.22
HS71913C	65	90	13	1.0	0.30	17	14.0	15.0	18000	30000	0.23
HS71913AC	65	90	13	1.0	0.30	25	13.2	14.1	16000	26000	0.23
HS71914C	70	100	16	1.0	0.30	19	18.3	19.9	17000	28000	0.38
HS71914AC	70	100	16	1.0	0.30	28	17.3	18.7	14000	22000	0.38
HS71915C	75	105	16	1.0	0.30	20	18.8	21.2	16000	26000	0.41
HS71915AC	75	105	16	1.0	0.30	29	17.6	20.0	14000	22000	0.41

Super-speed angular contact ball bearings

HS719 C

Contact angle $\alpha = 15^\circ$

HS719 AC

Contact angle $\alpha = 25^\circ$

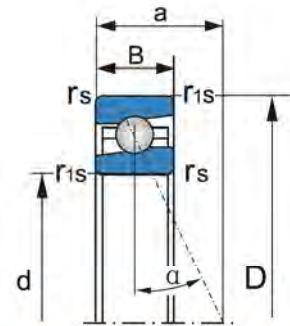

Bearing designations ZYS	Boundary dimensions						Load rating		Limiting speed		Weight kg ≈
	d	D	B	r _{smin}	r _{1smin}	a	C _r	C _{or}	Grease	Oil	
	mm					≈	KN		r/min		
HS71916C	80	110	16	1.0	0.30	21	21.0	23.9	15000	24000	0.42
HS71916AC	80	110	16	1.0	0.30	30	19.6	22.4	13000	20000	0.42
HS71917C	85	120	18	1.10	0.60	23	21.9	26.0	14000	22000	0.62
HS71917AC	85	120	18	1.10	0.60	33	20.4	24.5	12000	19000	0.62
HS71918C	90	125	18	1.10	0.60	23	23.6	28.5	14000	20000	0.64
HS71918AC	90	125	18	1.10	0.60	34	22.4	26.5	12000	19000	0.64
HS71919C	95	130	18	1.10	0.60	24	24.5	30.0	13000	20000	0.67
HS71919AC	95	130	18	1.10	0.60	35	22.8	28.0	12000	19000	0.67
HS71920C	100	140	20	1.10	0.60	26	29.0	36.0	12000	19000	0.92
HS71920AC	100	140	20	1.10	0.60	38	27.5	33.5	9500	16000	0.92
HS71921C	105	145	20	1.10	0.60	27	30.0	38.0	11000	18000	0.96
HS71921AC	105	145	20	1.10	0.60	39	28.0	35.5	9000	15000	0.96
HS71922C	110	150	20	1.10	0.60	27	34.5	43.8	9500	16000	0.98
HS71922AC	110	150	20	1.10	0.60	40	32.5	40.5	8000	13000	0.98
HS71924C	120	165	22	1.10	0.60	30	36.5	48.0	9000	15000	1.37
HS71924AC	120	165	22	1.10	0.60	44	34.0	45.0	8000	13000	1.37
HS71926C	130	180	24	1.50	0.60	33	41.1	55.9	8500	14000	1.77
HS71926AC	130	180	24	1.50	0.60	48	38.6	52.0	8000	13000	1.77
HS71928C	140	190	24	1.50	0.60	34	41.9	58.0	7500	12000	1.88
HS71928AC	140	190	24	1.50	0.60	50	39.4	54.0	7000	11000	1.88
HS71930C	150	210	28	2.00	1.0	38	47.5	71.1	7000	11000	2.94
HS71930AC	150	210	28	2.00	1.0	56	44.7	67.0	6300	9500	2.94
HS71932C	160	220	28	2.00	1.0	39	50.1	74.8	6300	9500	3.11
HS71932AC	160	220	28	2.00	1.0	58	47.1	70.5	6000	9000	3.11
HS71934C	170	230	28	2.00	1.0	41	57.7	86.8	6000	9000	3.22
HS71934AC	170	230	28	2.00	1.0	61	54.3	81.8	5300	8000	3.22
HS71936C	180	250	33	2.00	1.0	45	59.2	93.1	5300	8000	4.93
HS71936AC	180	250	33	2.00	1.0	67	55.7	87.7	5000	7500	4.93
HS71938C	190	260	33	2.00	1.0	47	75.0	116.1	5000	7500	5.03
HS71938AC	190	260	33	2.00	1.0	69	70.6	109.4	4500	6700	5.03
HS71940C	200	280	38	2.00	1.0	51	75.0	120.7	4800	7000	7.26
HS71940AC	200	280	38	2.00	1.0	75	70.5	113.7	4200	6300	7.26
HS71944C	220	300	38	2.00	1.0	54	84.6	139.6	4500	6700	7.77
HS71944AC	220	300	38	2.00	1.0	80	79.6	131.5	4000	6000	7.77

Super-speed angular contact ball bearings
 HS70 C
 Contact angle $\alpha = 15^\circ$
 HS70 AC
 Contact angle $\alpha = 25^\circ$

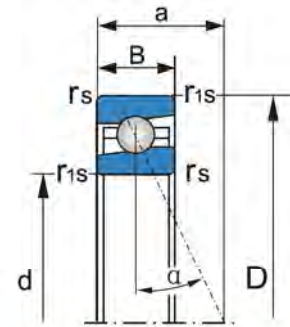

Bearing designations ZYS	Boundary dimensions						Load rating		Limiting speed		Weight kg ≈
	d	D	B	r _{smin}	r _{1smin}	a	C _r	C _{or}	Grease	Oil	
	mm						≈	KN		r/min	
HS708C	8	22	7	0.30	0.15	5.5	1.65	1.2	95000	160000	0.01
HS708AC	8	22	7	0.30	0.15	7	1.55	1.1	85000	140000	0.01
HS7000C	10	26	8	0.30	0.15	6	2.7	1.6	85000	140000	0.02
HS7000AC	10	26	8	0.30	0.15	8	2.6	1.5	70000	120000	0.02
HS7001C	12	28	8	0.30	0.15	7	2.7	1.6	75000	120000	0.02
HS7001AC	12	28	8	0.30	0.15	9	2.5	1.5	63000	100000	0.02
HS7002C	15	32	9	0.30	0.15	8	3.6	2.3	70000	110000	0.03
HS7002AC	15	32	9	0.30	0.15	10	3.5	2.2	60000	90000	0.03
HS7003C	17	35	10	0.30	0.15	8	3.8	2.5	60000	90000	0.04
HS7003AC	17	35	10	0.30	0.15	11	3.6	2.3	53000	80000	0.04
HS7004C	20	42	12	0.60	0.15	10	6.1	4.3	53000	80000	0.08
HS7004AC	20	42	12	0.60	0.15	13	5.8	4.1	45000	67000	0.08
HS7005C	25	47	12	0.60	0.15	11	6.2	4.6	45000	67000	0.09
HS7005AC	25	47	12	0.60	0.15	14	5.8	4.4	38000	56000	0.09
HS7006C	30	55	13	1.0	0.30	12	8.6	6.6	40000	60000	0.13
HS7006AC	30	55	13	1.0	0.30	16	8.1	6.3	36000	53000	0.13
HS7007C	35	62	14	1.0	0.30	13	9.2	7.8	36000	53000	0.18
HS7007AC	35	62	14	1.0	0.30	18	8.7	7.4	32000	48000	0.18
HS7008C	40	68	15	1.0	0.30	15	9.8	8.9	30000	45000	0.22
HS7008AC	40	68	15	1.0	0.30	20	9.3	8.4	26000	40000	0.22
HS7009C	45	75	16	1.0	0.30	16	12.5	11.4	26000	40000	0.28
HS7009AC	45	75	16	1.0	0.30	22	11.8	10.7	24000	38000	0.28
HS7010C	50	80	16	1.0	0.30	17	12.9	12.4	22000	36000	0.30
HS7010AC	50	80	16	1.0	0.30	23	12.2	11.7	19000	32000	0.30
HS7011C	55	90	18	1.10	0.60	19	18.6	17.8	20000	34000	0.44
HS7011AC	55	90	18	1.10	0.60	26	17.5	16.8	18000	30000	0.44
HS7012C	60	95	18	1.10	0.60	19	19.3	19.3	19000	32000	0.47
HS7012AC	60	95	18	1.10	0.60	27	18.2	18.2	16000	26000	0.47
HS7013C	65	100	18	1.10	0.60	20	19.9	20.8	17000	28000	0.50
HS7013AC	65	100	18	1.10	0.60	28	18.8	19.7	14000	22000	0.50
HS7014C	70	110	20	1.10	0.60	22	25.9	26.7	16000	26000	0.69
HS7014AC	70	110	20	1.10	0.60	31	24.4	25.2	14000	22000	0.69



Super-speed angular contact ball bearings

HS70 C

Contact angle $\alpha = 15^\circ$

HS70 AC

Contact angle $\alpha = 25^\circ$

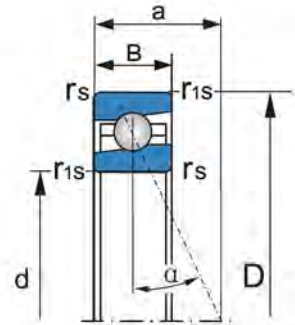

Bearing designations ZYS	Boundary dimensions						Load rating		Limiting speed		Weight kg ≈
	d	D	B	r _{smin}	r _{1smin}	a	C _r	C _{0r}	Grease	Oil	
	mm					≈	KN		r/min		
HS7015C	75	115	20	1.10	0.60	23	26.2	27.8	15000	24000	0.73
HS7015AC	75	115	20	1.10	0.60	32	24.7	26.3	13000	20000	0.73
HS7016C	80	125	22	1.10	0.60	25	31.2	33.5	14000	22000	0.99
HS7016AC	80	125	22	1.10	0.60	35	29.5	31.7	12000	19000	0.99
HS7017C	85	130	22	1.10	0.60	25	31.6	34.9	13000	20000	1.03
HS7017AC	85	130	22	1.10	0.60	36	29.9	32.9	11000	18000	1.03
HS7018C	90	140	24	1.50	0.60	27	37.1	41.4	12000	19000	1.35
HS7018AC	90	140	24	1.50	0.60	39	35.1	39.1	10000	17000	1.35
HS7019C	95	145	24	1.50	0.60	28	37.6	43.0	11000	18000	1.40
HS7019AC	95	145	24	1.50	0.60	40	35.5	40.6	10000	15000	1.40
HS7020C	100	150	24	1.50	0.60	29	38.1	44.6	11000	18000	1.46
HS7020AC	100	150	24	1.50	0.60	41	36.0	42.1	9000	15000	1.46
HS7021C	105	160	26	2.00	1.0	31	49.1	56.3	10000	17000	1.82
HS7021AC	105	160	26	2.00	1.0	44	46.4	53.2	8500	14000	1.82
HS7022C	110	170	28	2.00	1.0	33	49.7	58.5	10000	17000	2.31
HS7022AC	110	170	28	2.00	1.0	47	46.5	55.3	8500	14000	2.31
HS7024C	120	180	28	2.00	1.0	34	51.0	62.8	10000	15000	2.47
HS7024AC	120	180	28	2.00	1.0	49	48.0	58.5	8000	13000	2.47
HS7026C	130	200	33	2.00	1.0	39	65.4	81.5	8500	14000	3.68
HS7026AC	130	200	33	2.00	1.0	55	61.8	77.0	7500	12000	3.68
HS7028C	140	210	33	2.00	1.0	40	67.0	87.0	8000	13000	3.91
HS7028AC	140	210	33	2.00	1.0	57	63.0	81.5	7000	11000	3.91
HS7030C	150	225	35	2.10	1.0	43	81.5	106.0	7000	11000	4.71
HS7030AC	150	225	35	2.10	1.0	61	76.5	98.0	6700	10000	4.71
HS7032C	160	240	38	2.10	1.0	46	84.3	113.4	6300	9500	5.90
HS7032AC	160	240	38	2.10	1.0	66	79.6	107.2	6000	9000	5.90
HS7034C	170	260	42	2.10	1.10	50	102.7	139.6	6000	9000	7.94
HS7034AC	170	260	42	2.10	1.10	71	97.0	131.9	5300	8000	7.94
HS7036C	180	280	46	2.10	1.10	54	104.8	148.3	5600	8500	10.57
HS7036AC	180	280	46	2.10	1.10	77	99.0	140.1	5000	7500	10.57
HS7038C	190	290	46	2.10	1.10	55	123.7	173.9	5000	7500	10.84
HS7038AC	190	290	46	2.10	1.10	79	116.9	164.3	4500	6700	10.84
HS7040C	200	310	51	2.10	1.10	60	126.4	184.4	4800	7000	14.32
HS7040AC	200	310	51	2.10	1.10	85	119.4	174.2	4300	6300	14.32
HS7044C	220	340	56	3.00	1.10	66	147.7	219.5	4300	6300	18.82
HS7044AC	220	340	56	3.00	1.10	93	139.5	207.4	4000	6000	18.82

Super-speed angular contact ball bearings(ceramic balls)

HS719 C/HQ1

Contact angle $\alpha = 15^\circ$

HS719 AC/HQ1

Contact angle $\alpha = 25^\circ$

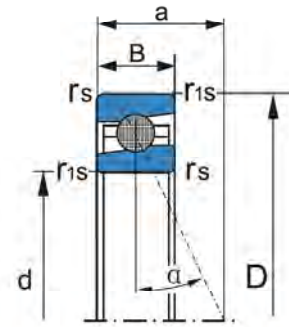

Bearing designations ZYS	Boundary dimensions						Load rating		Limiting speed		Weight kg ≈
	d	D	B	r _{smin}	r _{1smin}	a	C _r	C _{or}	Grease	Oil	
	mm						≈	KN		r/min	
HS71900 C/HQ1	10	22	6	0.30	0.10	5	1.9	1.0	100000	170000	0.01
HS71900 AC/HQ1	10	22	6	0.30	0.10	7	1.8	1.0	90000	150000	0.01
HS71901 C/HQ1	12	24	7	0.30	0.10	5	2.0	1.1	95000	160000	0.01
HS71901 AC/HQ1	12	24	7	0.30	0.10	7	1.9	1.1	85000	140000	0.01
HS71902 C/HQ1	15	28	7	0.30	0.10	6	2.2	1.4	85000	140000	0.02
HS71902 AC/HQ1	15	28	7	0.30	0.10	9	2.1	1.3	75000	120000	0.02
HS71903 C/HQ1	17	30	9	0.30	0.10	7	2.3	1.5	80000	130000	0.02
HS71903 AC/HQ1	17	30	9	0.30	0.10	9	2.2	1.4	67000	100000	0.02
HS71904 C/HQ1	20	37	9	0.30	0.10	8	3.9	2.7	67000	100000	0.04
HS71904 AC/HQ1	20	37	9	0.30	0.10	11	3.7	2.5	56000	85000	0.04
HS71905 C/HQ1	25	42	9	0.30	0.15	9	4.2	3.2	56000	85000	0.05
HS71905 AC/HQ1	25	42	9	0.30	0.15	12	3.9	3.0	48000	70000	0.05
HS71906 C/HQ1	30	47	10	0.30	0.15	10	6.3	4.9	50000	75000	0.05
HS71906 AC/HQ1	30	47	10	0.30	0.15	13	6.0	4.6	43000	63000	0.05
HS71907 C/HQ1	35	55	12	0.60	0.15	11	6.9	6.0	43000	63000	0.08
HS71907 AC/HQ1	35	55	12	0.60	0.15	15	6.5	5.6	36000	53000	0.08
HS71908 C/HQ1	40	62	12	0.60	0.15	13	7.2	6.8	36000	54000	0.12
HS71908 AC/HQ1	40	62	12	0.60	0.15	18	6.8	6.4	30000	45000	0.12
HS71909 C/HQ1	45	68	12	0.60	0.15	14	10.0	9.3	30000	45000	0.14
HS71909AC/HQ1	45	68	12	0.60	0.15	19	9.4	8.8	28000	43000	0.14
HS71910 C/HQ1	50	72	12	0.60	0.15	14	10.3	10.1	28000	43000	0.14
HS71910 AC/HQ1	50	72	12	0.60	0.15	20	9.7	9.5	24000	38000	0.14
HS71911 C/HQ1	55	80	13	0.60	0.15	16	13.2	12.9	24000	38000	0.19
HS71911 AC/HQ1	55	80	13	0.60	0.15	22	12.4	12.2	20000	34000	0.19
HS71912 C/HQ1	60	85	13	1.0	0.30	16	13.6	13.9	22000	36000	0.20
HS71912 AC/HQ1	60	85	13	1.0	0.30	23	12.8	13.2	19000	32000	0.20
HS71913 C/HQ1	65	90	13	1.0	0.30	17	14.0	15.0	20000	34000	0.21
HS71913 AC/HQ1	65	90	13	1.0	0.30	25	13.2	14.1	18000	30000	0.21
HS71914 C/HQ1	70	100	16	1.0	0.30	19	18.3	19.9	19000	32000	0.36
HS71914 AC/HQ1	70	100	16	1.0	0.30	28	17.3	18.7	16000	26000	0.36
HS71915 C/HQ1	75	105	16	1.0	0.30	20	18.8	21.2	18000	30000	0.39
HS71915 AC/HQ1	75	105	16	1.0	0.30	29	17.6	20.0	16000	24000	0.39

Super-speed angular contact ball bearings(ceramic balls)

HS719 C/HQ1

Contact angle $\alpha = 15^\circ$

HS719 AC/HQ1

Contact angle $\alpha = 25^\circ$

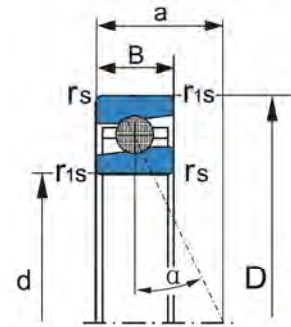

Bearing designations ZYS	Boundary dimensions						Load rating		Limiting speed		Weight kg ≈
	d	D	B	r _{smin}	r _{1smin}	a	C _r	C _{or}	Grease	Oil	
	mm					≈	KN		r/min		
HS71916 C/HQ1	80	110	16	1.0	0.30	21	21.0	23.9	17000	28000	0.40
HS71916 AC/HQ1	80	110	16	1.0	0.30	30	19.6	22.4	15000	24000	0.40
HS71917 C/HQ1	85	120	18	1.10	0.60	23	21.9	26.0	16000	26000	0.58
HS71917 AC/HQ1	85	120	18	1.10	0.60	33	20.4	24.5	14000	22000	0.58
HS71918 C/HQ1	90	125	18	1.10	0.60	23	23.6	28.5	16000	26000	0.60
HS71918AC/HQ1	90	125	18	1.10	0.60	34	22.4	26.5	14000	22000	0.60
HS71919 C/HQ1	95	130	18	1.10	0.60	24	24.5	30.0	15000	24000	0.62
HS71919 AC/HQ1	95	130	18	1.10	0.60	35	22.8	28.0	14000	22000	0.62
HS71920 C/HQ1	100	140	20	1.10	0.60	26	29.0	36.0	14000	22000	0.86
HS71920 AC/HQ1	100	140	20	1.10	0.60	38	27.5	33.5	12000	19000	0.86
HS71921 C/HQ1	105	145	20	1.10	0.60	27	30.0	38.0	13000	20000	0.89
HS71921 AC/HQ1	105	145	20	1.10	0.60	39	28.0	35.5	11000	18000	0.89
HS71922 C/HQ1	110	150	20	1.10	0.60	27	34.5	43.8	12000	19000	0.90
HS71922 AC/HQ1	110	150	20	1.10	0.60	40	32.5	40.5	10000	17000	0.90
HS71924 C/HQ1	120	165	22	1.10	0.60	30	36.5	48.0	11000	18000	1.28
HS71924 AC/HQ1	120	165	22	1.10	0.60	44	34.0	45.0	9500	16000	1.28
HS71926 C/HQ1	130	180	24	1.50	0.60	33	41.1	55.9	9500	16000	1.68
HS71926 AC/HQ1	130	180	24	1.50	0.60	48	38.6	52.0	9000	15000	1.68
HS71928 C/HQ1	140	190	24	1.50	0.60	34	41.9	58.0	8500	14000	1.79
HS71928 AC/HQ1	140	190	24	1.50	0.60	50	39.4	54.0	8000	13000	1.79
HS71930 C/HQ1	150	210	28	2.00	1.0	38	47.5	71.1	8000	13000	2.83
HS71930 AC/HQ1	150	210	28	2.00	1.0	56	44.7	67.0	7500	12000	2.83
HS71932 C/HQ1	160	220	28	2.00	1.0	39	50.1	74.8	7500	12000	2.98
HS71932 AC/HQ1	160	220	28	2.00	1.0	58	47.1	70.5	7000	11000	2.98
HS71934 C/HQ1	170	230	28	2.00	1.0	41	57.7	86.8	7000	11000	3.07
HS71934 AC/HQ1	170	230	28	2.00	1.0	61	54.3	81.8	6300	9500	3.07
HS71936 C/HQ1	180	250	33	2.00	1.0	45	59.2	93.1	6300	9500	4.77
HS71936 AC/HQ1	180	250	33	2.00	1.0	67	55.7	87.7	6000	9000	4.77
HS71938 C/HQ1	190	260	33	2.00	1.0	47	75.0	116.1	6000	9000	4.80
HS71938 AC/HQ1	190	260	33	2.00	1.0	69	70.6	109.4	5300	8000	4.80
HS71940 C/HQ1	200	280	38	2.00	1.0	51	75.0	120.7	5300	8000	7.02
HS71940 AC/HQ1	200	280	38	2.00	1.0	75	70.5	113.7	4800	7000	7.02
HS71944 C/HQ1	220	300	38	2.00	1.0	54	84.6	139.6	5300	8000	7.47
HS71944 AC/HQ1	220	300	38	2.00	1.0	80	79.6	131.5	4500	6700	7.47

Super-speed angular contact ball bearings(ceramic balls)

HS70 C/HQ1

Contact angle $\alpha=15^\circ$

HS70 AC/HQ1

Contact angle $\alpha=25^\circ$

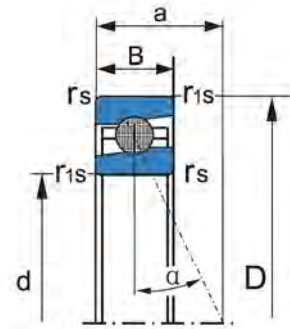

Bearing designations ZYS	Boundary dimensions						Load rating		Limiting speed		Weight kg ≈
	d	D	B	r _{smin}	r _{1smin}	a	C _r	C _{or}	Grease	Oil	
	mm					≈	KN		r/min		
HS7000 C/HQ1	10	26	8	0.30	0.15	6	2.7	1.6	95000	160000	0.02
HS7000 AC/HQ1	10	26	8	0.30	0.15	8	2.6	1.5	85000	140000	0.02
HS7001 C/HQ1	12	28	8	0.30	0.15	7	2.7	1.6	85000	140000	0.02
HS7001 AC/HQ1	12	28	8	0.30	0.15	9	2.5	1.5	75000	120000	0.02
HS7002 C/HQ1	15	32	9	0.30	0.15	8	3.6	2.3	80000	130000	0.03
HS7002 AC/HQ1	15	32	9	0.30	0.15	10	3.5	2.2	70000	110000	0.03
HS7003 C/HQ1	17	35	10	0.30	0.15	8	3.8	2.5	67000	100000	0.04
HS7003 AC/HQ1	17	35	10	0.30	0.15	11	3.6	2.3	63000	95000	0.04
HS7004 C/HQ1	20	42	12	0.60	0.15	10	6.1	4.3	63000	95000	0.08
HS7004 AC/HQ1	20	42	12	0.60	0.15	13	5.8	4.1	50000	75000	0.08
HS7005 C/HQ1	25	47	12	0.60	0.15	11	6.2	4.6	50000	75000	0.09
HS7005 AC/HQ1	25	47	12	0.60	0.15	14	5.8	4.4	45000	67000	0.09
HS7006 C/HQ1	30	55	13	1.0	0.30	12	8.6	6.6	48000	70000	0.13
HS7006 AC/HQ1	30	55	13	1.0	0.30	16	8.1	6.3	40000	60000	0.13
HS7007 C/HQ1	35	62	14	1.0	0.30	13	9.2	7.8	40000	60000	0.18
HS7007 AC/HQ1	35	62	14	1.0	0.30	18	8.7	7.4	36000	53000	0.18
HS7008 C/HQ1	40	68	15	1.0	0.30	15	9.8	8.9	36000	53000	0.20
HS7008 AC/HQ1	40	68	15	1.0	0.30	20	9.3	8.4	30000	45000	0.20
HS7009 C/HQ1	45	75	16	1.0	0.30	16	12.5	11.4	30000	45000	0.26
HS7009 AC/HQ1	45	75	16	1.0	0.30	22	11.8	10.7	28000	43000	0.26
HS7010 C/HQ1	50	80	16	1.0	0.30	17	12.9	12.4	26000	40000	0.28
HS7010 AC/HQ1	50	80	16	1.0	0.30	23	12.2	11.7	22000	36000	0.28
HS7011 C/HQ1	55	90	18	1.10	0.60	19	18.6	17.8	24000	38000	0.41
HS7011 AC/HQ1	55	90	18	1.10	0.60	26	17.5	16.8	20000	34000	0.41
HS7012 C/HQ1	60	95	18	1.10	0.60	19	19.3	19.3	22000	36000	0.43
HS7012 AC/HQ1	60	95	18	1.10	0.60	27	18.2	18.2	19000	32000	0.43
HS7013 C/HQ1	65	100	18	1.10	0.60	20	19.9	20.8	20000	34000	0.46
HS7013 AC/HQ1	65	100	18	1.10	0.60	28	18.8	19.7	16000	26000	0.46
HS7014 C/HQ1	70	110	20	1.10	0.60	22	25.9	26.7	19000	32000	0.64
HS7014 AC/HQ1	70	110	20	1.10	0.60	31	24.4	25.2	16000	26000	0.64
HS7015 C/HQ1	75	115	20	1.10	0.60	23	26.2	27.8	17000	28000	0.67
HS7015 AC/HQ1	75	115	20	1.10	0.60	32	24.7	26.3	15000	24000	0.67

Super-speed angular contact ball bearings (ceramic balls)

HS70 C/HQ1

Contact angle $\alpha = 15^\circ$

HS70 AC/HQ1

Contact angle $\alpha = 25^\circ$

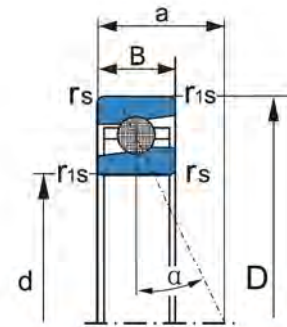

Bearing designations ZYS	Boundary dimensions						Load rating		Limiting speed		Weight kg ≈
	d	D	B	r _{smin}	r _{1smin}	a	C _r	C _{or}	Grease	Oil	
	mm					≈	KN		r/min		
HS7016 C/HQ1	80	125	22	1.10	0.60	25	31.2	33.5	16000	26000	0.90
HS7016 AC/HQ1	80	125	22	1.10	0.60	35	29.5	31.7	14000	22000	0.90
HS7017 C/HQ1	85	130	22	1.10	0.60	25	31.6	34.9	15000	24000	0.94
HS7017 AC/HQ1	85	130	22	1.10	0.60	36	29.9	32.9	13000	20000	0.94
HS7018 C/HQ1	90	140	24	1.50	0.60	27	37.1	41.4	14000	22000	1.24
HS7018AC/HQ1	90	140	24	1.50	0.60	39	35.1	39.1	13000	20000	1.24
HS7019 C/HQ1	95	145	24	1.50	0.60	28	37.6	43.0	13000	20000	1.26
HS7019 AC/HQ1	95	145	24	1.50	0.60	40	35.5	40.6	11000	18000	1.26
HS7020 C/HQ1	100	150	24	1.50	0.60	29	38.1	44.6	13000	20000	1.34
HS7020 AC/HQ1	100	150	24	1.50	0.60	41	36.0	42.1	11000	18000	1.34
HS7021 C/HQ1	105	160	26	2.00	1.0	31	49.1	56.3	12000	20000	1.66
HS7021 AC/HQ1	105	160	26	2.00	1.0	44	46.4	53.2	9500	16000	1.66
HS7022 C/HQ1	110	170	28	2.00	1.0	33	49.7	58.5	12000	19000	2.16
HS7022 AC/HQ1	110	170	28	2.00	1.0	47	46.5	55.3	9500	16000	2.16
HS7024 C/HQ1	120	180	28	2.00	1.0	34	51.0	62.8	11000	18000	2.21
HS7024 AC/HQ1	120	180	28	2.00	1.0	49	48.0	58.5	9500	16000	2.21
HS7026 C/HQ1	130	200	33	2.00	1.0	39	65.4	81.5	9500	16000	3.52
HS7026 AC/HQ1	130	200	33	2.00	1.0	55	61.0	77.0	8500	14000	3.52
HS7028 C/HQ1	140	210	33	2.00	1.0	40	67.0	87.0	9000	15000	3.73
HS7028 AC/HQ1	140	210	33	2.00	1.0	57	63.0	81.5	8000	13000	3.73
HS7030 C/HQ1	150	225	35	2.10	1.0	43	81.5	106.0	8000	13000	4.46
HS7030 AC/HQ1	150	225	35	2.10	1.0	61	76.5	98.0	7500	12000	4.46
HS7032 C/HQ1	160	240	38	2.10	1.0	46	84.3	113.4	7000	11000	5.64
HS7032 AC/HQ1	160	240	38	2.10	1.0	66	79.6	107.2	6700	10000	5.64
HS7034 C/HQ1	170	260	42	2.10	1.10	50	102.7	139.6	6700	10000	7.95
HS7034 AC/HQ1	170	260	42	2.10	1.10	71	97.0	131.9	6000	9000	7.95
HS0936 C/HQ1	180	280	46	2.10	1.10	54	104.8	148.3	6300	9500	10.20
HS7036 AC/HQ1	180	280	46	2.10	1.10	77	99.0	140.1	5600	8500	10.20
HS7038 C/HQ1	190	290	46	2.10	1.10	55	123.7	173.9	5600	8500	10.36
HS7038 AC/HQ1	190	290	46	2.10	1.10	79	116.9	164.3	5000	7500	10.36
HS7040 C/HQ1	200	310	51	2.10	1.10	60	126.4	184.4	5300	8000	13.81
HS7040 AC/HQ1	200	310	51	2.10	1.10	85	119.4	174.2	4800	7000	13.81
HS7044 C/HQ1	220	340	56	3.00	1.10	66	147.7	219.5	4800	7000	18.16
HS7044 AC/HQ1	220	340	56	3.00	1.10	93	139.5	207.4	4300	6300	18.16

Angular contact ball bearings with direct lubrication

H719 C-DL

Contact angle $\alpha=15^\circ$

H719 AC-DL

Contact angle $\alpha=25^\circ$

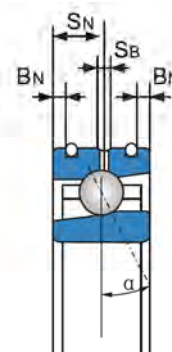

Bearing designations ZYS	Boundary dimensions						DLR dimensions			Load rating		Limiting speed	Weight
	d	D	B	r _{smin}	r _{ismin}	a	BN	SN	SB	C _r	C _{or}	Oil	kg
	mm						mm			KN		r/min	≈
H71906 C-DL	30	47	10	0.30	0.15	10	1.1	5.3	1.4	5.8	3.8	75000	0.5
H71906 AC-DL	30	47	10	0.30	0.15	13	1.1	5.3	1.4	5.4	3.6	63000	0.5
H71907 C-DL	35	55	12	0.60	0.15	11	1.6	5.8	1.4	7.7	5.4	63000	0.7
H71907 AC-DL	35	55	12	0.60	0.15	15	1.6	5.8	1.4	7.4	5.1	53000	0.7
H71908 C-DL	40	62	12	0.60	0.15	13	2.2	6.6	1.4	9.8	7.0	53000	0.12
H71908 AC-DL	40	62	12	0.60	0.15	18	2.2	6.6	1.4	9.3	6.6	48000	0.12
H71909 C-DL	45	68	12	0.60	0.15	14	2.2	6.6	1.4	10.3	7.7	48000	0.14
H71909AC-DL	45	68	12	0.60	0.15	19	2.2	6.6	1.4	9.7	7.3	43000	0.14
H71910 C-DL	50	72	12	0.60	0.15	14	2.2	6.6	1.4	13.2	10.0	43000	0.14
H71910 AC-DL	50	72	12	0.60	0.15	20	2.2	6.6	1.4	12.5	9.5	38000	0.14
H71911 C-DL	55	80	13	0.60	0.15	16	2.8	7.2	1.4	16.0	12.6	38000	0.18
H71911 AC-DL	55	80	13	0.60	0.15	22	2.8	7.2	1.4	15.0	11.9	30000	0.18
H71912 C-DL	60	85	13	1.0	0.30	16	2.8	7.2	1.4	16.6	13.8	36000	0.20
H71912 AC-DL	60	85	13	1.0	0.30	23	2.8	7.2	1.4	15.7	13.1	28000	0.20
H71913 C-DL	65	90	13	1.0	0.30	17	2.8	7.2	1.4	16.8	14.5	32000	0.21
H71913 AC-DL	65	90	13	1.0	0.30	25	2.8	7.2	1.4	16.0	13.7	28000	0.21
H71914 C-DL	70	100	16	1.0	0.30	19	3.1	9.3	1.4	20.9	17.8	30000	0.35
H71914 AC-DL	70	100	16	1.0	0.30	28	3.1	9.3	1.4	19.7	16.9	24000	0.35
H71915 C-DL	75	105	16	1.0	0.30	20	3.1	9.3	1.4	21.7	19.3	28000	0.37
H71915 AC-DL	75	105	16	1.0	0.30	29	3.1	9.3	1.4	20.5	18.2	24000	0.37
H71916 C-DL	80	110	16	1.0	0.30	21	3.1	9.3	1.4	22.4	20.8	26000	0.39
H71916 AC-DL	80	110	16	1.0	0.30	30	3.1	9.3	1.4	21.2	19.6	22000	0.39
H71917 C-DL	85	120	18	1.10	0.60	23	4.0	10.4	2.2	26.1	24.2	24000	0.56
H71917 AC-DL	85	120	18	1.10	0.60	33	4.0	10.4	2.2	24.7	22.9	22000	0.56
H71918 C-DL	90	125	18	1.10	0.60	23	4.0	10.4	2.2	27.0	26.0	24000	0.59
H71918AC-DL	90	125	18	1.10	0.60	34	4.0	10.4	2.2	25.5	24.6	20000	0.59
H71919 C-DL	95	130	18	1.10	0.60	24	4.0	10.4	2.2	27.3	26.9	22000	0.62
H71919 AC-DL	95	130	18	1.10	0.60	35	4.0	10.4	2.2	25.8	25.4	20000	0.62



Angular contact ball bearings with direct lubrication

H719 C-DL

Contact angle $\alpha = 15^\circ$

H719 AC-DL

Contact angle $\alpha \approx 25^\circ$

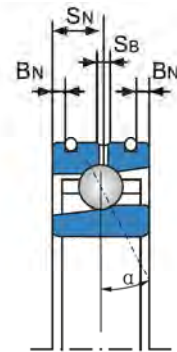

Bearing designations ZYS	Boundary dimensions						DLR dimensions			Load rating		Limiting speed	Weight kg ≈
	d	D	B	r _{smin}	r _{lmin}	a	BN	SN	SB	C _r	C _{or}	Oil	
	mm						mm			KN		r/min	
H71920 C-DL	100	140	20	1.10	0.60	26	4.0	12.0	2.2	40.1	37.6	20000	0.82
H71920 AC-DL	100	140	20	1.10	0.60	38	4.0	12.0	2.2	37.9	35.5	18000	0.82
H71921 C-DL	105	145	20	1.10	0.60	27	4.0	12.0	2.2	40.7	39.1	20000	0.85
H71921 AC-DL	105	145	20	1.10	0.60	39	4.0	12.0	2.2	38.4	36.9	16000	0.85
H71922 C-DL	110	150	20	1.10	0.60	27	4.0	12.0	2.2	41.6	40.5	18000	0.89
H71922 AC-DL	110	150	20	1.10	0.60	40	4.0	12.0	2.2	39.0	38.3	14000	0.89
H71924 C-DL	120	165	22	1.10	0.60	30	4.0	12.0	2.2	43.1	44.9	16000	1.25
H71924 AC-DL	120	165	22	1.10	0.60	44	4.0	12.0	2.2	40.7	42.4	14000	1.25

Angular contact ball bearings with direct lubrication

H70 C-DL

Contact angle $\alpha = 15^\circ$

H70 AC-DL

Contact angle $\alpha = 25^\circ$

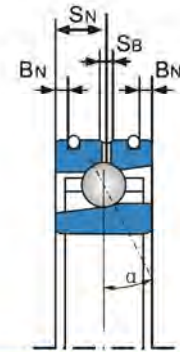

Bearing designations ZYS	Boundary dimensions						DLR dimensions			Load rating		Limiting speed	Weight kg ≈
	d	D	B	r _{smin}	r _{lmin}	a	BN	SN	SB	C _r	C _{or}	Oil	
	mm						mm			KN		r/min	
H7006 C-DL	30	55	13	1.0	0.30	12	2.8	7.2	1.4	9.5	6.2	67000	0.11
H7006 AC-DL	30	55	13	1.0	0.30	16	2.8	7.2	1.4	9.0	5.9	60000	0.11
H7007 C-DL	35	62	14	1.0	0.30	13	2.8	8.0	1.4	11.2	7.9	60000	0.15
H7007 AC-DL	35	62	14	1.0	0.30	18	2.8	8.0	1.4	10.7	7.5	53000	0.15
H7008 C-DL	40	68	15	1.0	0.30	15	2.8	8.5	1.4	12.5	9.1	50000	0.19
H7008 AC-DL	40	68	15	1.0	0.30	20	2.8	8.5	1.4	11.1	8.6	45000	0.19
H7009 C-DL	45	75	16	1.0	0.30	16	3.4	9.3	1.4	13.1	10.2	45000	0.24
H7009AC-DL	45	75	16	1.0	0.30	22	3.4	9.3	1.4	12.5	9.7	43000	0.24
H7010 C-DL	50	80	16	1.0	0.30	17	3.4	9.3	1.4	15.4	12.0	40000	0.26
H7010 AC-DL	50	80	16	1.0	0.30	23	3.4	9.3	1.4	14.7	11.4	36000	0.26
H7011 C-DL	55	90	18	1.10	0.60	19	4.3	9.7	1.4	17.0	14.5	38000	0.41
H7011 AC-DL	55	90	18	1.10	0.60	26	4.3	9.7	1.4	16.0	13.7	32000	0.41
H7012 C-DL	60	95	18	1.10	0.60	19	4.3	9.7	1.4	17.0	15.3	36000	0.44
H7012 AC-DL	60	95	18	1.10	0.60	27	4.3	9.7	1.4	16.2	14.4	28000	0.44
H7013 C-DL	65	100	18	1.10	0.60	20	4.0	10.4	1.4	20	18.6	30000	0.45
H7013 AC-DL	65	100	18	1.10	0.60	28	4.0	10.4	1.4	19.0	17.6	24000	0.45
H7014 C-DL	70	110	20	1.10	0.60	22	4.0	11.6	1.4	24.1	21.4	28000	0.64
H7014 AC-DL	70	110	20	1.10	0.60	31	4.0	11.6	1.4	22.6	20.1	24000	0.64
H7015 C-DL	75	115	20	1.10	0.60	23	4.0	11.6	1.4	26.2	25.5	26000	0.68
H7015 AC-DL	75	115	20	1.10	0.60	32	4.0	11.6	2.2	24.7	24.2	22000	0.68
H7016 C-DL	80	125	22	1.10	0.60	25	4.7	12.2	2.2	34.2	32.7	24000	0.90
H7016 AC-DL	80	125	22	1.10	0.60	35	4.7	12.2	2.2	32.3	31.0	20000	0.90
H7017 C-DL	85	130	22	1.10	0.60	25	4.7	12.2	2.2	35.0	35.2	22000	0.95
H7017 AC-DL	85	130	22	1.10	0.60	36	4.7	12.2	2.2	33.0	33.4	20000	0.95
H7018 C-DL	90	140	24	1.50	0.60	27	5.5	14.5	2.2	36.4	38.1	22000	1.26
H7018AC-DL	90	140	24	1.50	0.60	39	5.5	14.5	2.2	34.3	36.1	18000	1.26
H7019 C-DL	95	145	24	1.50	0.60	28	5.5	14.5	2.2	44.4	45.2	20000	1.27
H7019 AC-DL	95	145	24	1.50	0.60	40	5.5	14.5	2.2	41.9	42.9	16000	1.27
H7020 C-DL	100	150	24	1.50	0.60	29	5.5	14.5	2.2	45.4	48.1	20000	1.33
H7020 AC-DL	100	150	24	1.50	0.60	41	5.5	14.5	2.2	42.7	44.7	16000	1.33
H7021 C-DL	105	160	26	2.00	1.0	31	6.0	15.2	2.2	46.1	49.2	19000	1.72
H7021 AC-DL	105	160	26	2.00	1.0	44	6.0	15.2	2.2	43.3	46.6	15000	1.72
H7022 C-DL	110	170	28	2.00	1.0	33	6.0	16.2	2.2	47.9	53.9	19000	2.20
H7022 AC-DL	110	170	28	2.00	1.0	47	6.0	16.2	2.2	45.1	51.1	15000	2.20
H7024 C-DL	120	180	28	2.00	1.0	34	6.0	16.2	2.2	58.3	64.9	16000	2.30
H7024 AC-DL	120	180	28	2.00	1.0	49	6.0	16.2	2.2	54.8	61.5	14000	2.30

Angular contact ball bearings with direct lubrication (ceramic balls)

H719 C-DL/HQ1

Contact angle $\alpha = 15^\circ$

H719 AC-DL/HQ1

Contact angle $\alpha = 25^\circ$

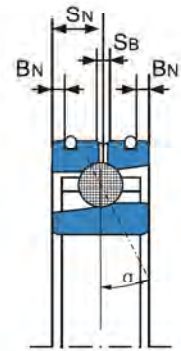

Bearing designations ZYS	Boundary dimensions						DLR dimensions			Load rating		Limiting speed	Weight kg ≈
	d	D	B	r _{smin}	r _{ismin}	a	BN	SN	SB	C _r	C _{or}	Oil	
	mm					≈	mm	mm	mm	KN		r/min	
H71906 C-DL /HQ1	30	47	10	0.30	0.15	10	1.1	5.3	1.4	5.8	3.8	85000	0.04
H71906 AC-DL /HQ1	30	47	10	0.30	0.15	13	1.1	5.3	1.4	5.4	3.6	70000	0.04
H71907 C-DL /HQ1	35	55	12	0.60	0.15	11	1.6	5.8	1.4	7.7	5.4	70000	0.07
H71907 AC-DL /HQ1	35	55	12	0.60	0.15	15	1.6	5.8	1.4	7.4	5.1	60000	0.07
H71908 C-DL /HQ1	40	62	12	0.60	0.15	13	2.2	6.6	1.4	9.8	7.0	60000	0.10
H71908 AC-DL /HQ1	40	62	12	0.60	0.15	18	2.2	6.6	1.4	9.3	6.6	50000	0.10
H71909 C-DL /HQ1	45	68	12	0.60	0.15	14	2.2	6.6	1.4	10.3	7.7	50000	0.12
H71909 AC-DL /HQ1	45	68	12	0.60	0.15	19	2.2	6.6	1.4	9.7	7.3	48000	0.12
H71910 C-DL /HQ1	50	72	12	0.60	0.15	14	2.2	6.6	1.4	13.2	10.0	48000	0.12
H71910 AC-DL /HQ1	50	72	12	0.60	0.15	20	2.2	6.6	1.4	12.5	9.5	43000	0.12
H71911 C-DL /HQ1	55	80	13	1.0	0.30	16	2.8	7.2	1.4	16.0	12.6	43000	0.15
H71911 AC-DL /HQ1	55	80	13	1.0	0.30	22	2.8	7.2	1.4	15.0	11.9	38000	0.15
H71912 C-DL /HQ1	60	85	13	1.0	0.30	16	2.8	7.2	1.4	16.6	13.8	40000	0.16
H71912 AC-DL /HQ1	60	85	13	1.0	0.30	23	2.8	7.2	1.4	15.7	13.1	36000	0.16
H71913 C-DL /HQ1	65	90	13	1.0	0.30	17	2.8	7.2	1.4	16.8	14.5	38000	0.17
H71913 AC-DL /HQ1	65	90	13	1.0	0.30	25	2.8	7.2	1.4	16.0	13.7	32000	0.17
H71914 C-DL /HQ1	70	100	16	1.0	0.30	19	3.1	9.3	1.4	20.9	17.8	36000	0.28
H71914 AC-DL /HQ1	70	100	16	1.0	0.30	28	3.1	9.3	1.4	19.7	16.9	28000	0.28
H71915 C-DL /HQ1	75	105	16	1.0	0.30	20	3.1	9.3	1.4	21.7	19.3	32000	0.30
H71915 AC-DL /HQ1	75	105	16	1.0	0.30	29	3.1	9.3	1.4	20.5	18.2	28000	0.30
H71916 C-DL /HQ1	80	110	16	1.0	0.30	21	3.1	9.3	1.4	22.4	20.8	30000	0.31
H71916 AC-DL /HQ1	80	110	16	1.0	0.30	30	3.1	9.3	1.4	21.2	19.6	26000	0.31
H71917 C-DL /HQ1	85	120	18	1.10	0.60	23	4.0	10.4	2.2	26.1	24.2	28000	0.44
H71917 AC-DL /HQ1	85	120	18	1.10	0.60	33	4.0	10.4	2.2	24.7	22.9	24000	0.44
H71918 C-DL /HQ1	90	125	18	1.10	0.60	23	4.0	10.4	2.2	27.0	26.0	28000	0.46
H71918 AC-DL /HQ1	90	125	18	1.10	0.60	34	4.0	10.4	2.2	25.5	24.6	24000	0.46
H71919 C-DL /HQ1	95	130	18	1.10	0.60	24	4.0	10.4	2.2	27.3	26.9	26000	0.48
H71919 AC-DL /HQ1	95	130	18	1.10	0.60	35	4.0	10.4	2.2	25.8	25.4	24000	0.48

Angular contact ball bearings with direct lubrication (ceramic balls)

H719 C-DL/HQ1

Contact angle $\alpha = 15^\circ$

H719 AC-DL/HQ1

Contact angle $\alpha = 25^\circ$

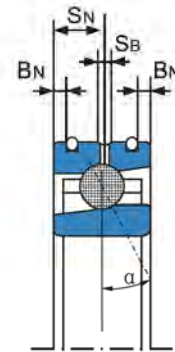

Bearing designations ZYS	Boundary dimensions						DLR dimensions			Load rating		Limiting speed	Weight kg ≈
	d	D	B	r _{smin}	r _{lmin}	a	BN	SN	SB	C _r	C _{or}	Oil	
	mm						mm			KN		r/min	
H71920 C-DL/HQ1	100	140	20	1.10	0.60	26	4.0	12.0	2.2	40.1	37.6	24000	0.66
H71920 AC-DL/HQ1	100	140	20	1.10	0.60	38	4.0	12.0	2.2	37.9	35.5	20000	0.66
H71921 C-DL/HQ1	105	145	20	1.10	0.60	27	4.0	12.0	2.2	40.7	39.1	22000	0.69
H71921 AC-DL/HQ1	105	145	20	1.10	0.60	39	4.0	12.0	2.2	38.4	36.9	20000	0.69
H71922 C-DL/HQ1	110	150	20	1.10	0.60	27	4.0	12.0	2.2	41.3	40.5	22000	0.71
H71922 AC-DL/HQ1	110	150	20	1.10	0.60	40	4.0	12.0	2.2	39.0	38.3	19000	0.71
H71924 C-DL/HQ1	120	165	22	1.10	0.60	30	4.0	12.0	2.2	43.1	44.9	20000	0.97
H71924 AC-DL/HQ1	120	165	22	1.10	0.60	44	4.0	12.0	2.2	40.7	42.4	18000	0.97

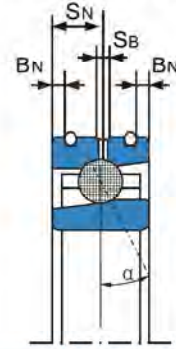

Angular contact ball bearings with direct lubrication (ceramic balls)

H70 C-DL/HQ1

Contact angle $\alpha=15^\circ$

H70 AC-DL/HQ1

Contact angle $\alpha=25^\circ$

Bearing designations ZYS	Boundary dimensions						DLR dimensions			Load rating		Limiting speed	Weight kg ≈
	d	D	B	r _{smin}	r _{smin}	a	BN	SN	SB	C _r	C _{or}	Oil	
	mm						mm			KN		r/min	
H7006 C-DL /HQ1	30	55	13	1.0	0.30	12	2.8	7.2	1.4	9.5	6.2	80000	0.11
H7006 AC-DL /HQ1	30	55	13	1.0	0.30	16	2.8	7.2	1.4	9.0	5.9	67000	0.11
H7007 C-DL /HQ1	35	62	14	1.0	0.30	13	2.8	8.0	1.4	11.2	7.9	67000	0.14
H7007 AC-DL /HQ1	35	62	14	1.0	0.30	18	2.8	8.0	1.4	10.7	7.5	60000	0.14
H7008 C-DL /HQ1	40	68	15	1.0	0.30	15	2.8	8.5	1.4	12.5	9.1	60000	0.18
H7008 AC-DL /HQ1	40	68	15	1.0	0.30	20	2.8	8.5	1.4	11.1	8.6	50000	0.18
H7009 C-DL /HQ1	45	75	16	1.0	0.30	16	3.4	9.3	1.4	13.1	10.2	50000	0.24
H7009AC-DL /HQ1	45	75	16	1.0	0.30	22	3.4	9.3	1.4	12.5	9.7	48000	0.24
H7010 C-DL /HQ1	50	80	16	1.0	0.30	17	3.4	9.3	1.4	15.4	12.0	45000	0.24
H7010 AC-DL /HQ1	50	80	16	1.0	0.30	23	3.4	9.3	1.4	14.7	11.4	40000	0.24
H7011 C-DL /HQ1	55	90	18	1.10	0.60	19	4.3	9.7	1.4	17.0	14.5	43000	0.38
H7011 AC-DL /HQ1	55	90	18	1.10	0.60	26	4.3	9.7	1.4	16.0	13.7	38000	0.38
H7012 C-DL /HQ1	60	95	18	1.10	0.60	19	4.3	9.7	1.4	17.0	15.3	40000	0.41
H7012 AC-DL /HQ1	60	95	18	1.10	0.60	27	4.3	9.7	1.4	16.2	14.4	36000	0.41
H7013 C-DL /HQ1	65	100	18	1.10	0.60	20	4.0	10.4	1.4	20.2	18.6	38000	0.42
H7013 AC-DL /HQ1	65	100	18	1.10	0.60	28	4.0	10.4	1.4	19.0	17.6	28000	0.42
H7014 C-DL /HQ1	70	110	20	1.10	0.60	22	4.0	11.6	1.4	24.1	21.4	36000	0.59
H7014 AC-DL /HQ1	70	110	20	1.10	0.60	31	4.0	11.6	1.4	22.6	20.1	28000	0.59
H7015 C-DL /HQ1	75	115	20	1.10	0.60	23	4.0	11.6	1.4	26.2	25.5	30000	0.63
H7015 AC-DL /HQ1	75	115	20	1.10	0.60	32	4.0	11.6	2.2	24.7	24.2	26000	0.63
H7016 C-DL /HQ1	80	125	22	1.10	0.60	25	4.7	12.2	2.2	34.2	32.7	28000	0.82
H7016 AC-DL /HQ1	80	125	22	1.10	0.60	35	4.7	12.2	2.2	32.3	31.0	24000	0.82
H7017 C-DL /HQ1	85	130	22	1.10	0.60	25	4.7	12.2	2.2	35.0	35.2	26000	0.86
H7017 AC-DL /HQ1	85	130	22	1.10	0.60	36	4.7	12.2	2.2	33.0	33.4	22000	0.86
H7018 C-DL /HQ1	90	140	24	1.50	0.60	27	5.5	14.5	2.2	36.4	38.1	24000	1.17
H7018AC-DL /HQ1	90	140	24	1.50	0.60	39	5.5	14.5	2.2	34.3	36.1	20000	1.17
H7019 C-DL /HQ1	95	145	24	1.50	0.60	28	5.5	14.5	2.2	44.4	45.2	22000	1.18
H7019 AC-DL /HQ1	95	145	24	1.50	0.60	40	5.5	14.5	2.2	41.9	42.9	20000	1.18
H7020 C-DL /HQ1	100	150	24	1.50	0.60	29	5.5	14.5	2.2	45.4	48.1	22000	1.20
H7020 AC-DL /HQ1	100	150	24	1.50	0.60	41	5.5	14.5	2.2	42.7	44.7	20000	1.20
H7021 C-DL /HQ1	105	160	26	2.00	1.0	31	6.0	15.2	2.2	46.1	49.2	20000	1.58
H7021 AC-DL /HQ1	105	160	26	2.00	1.0	44	6.0	15.2	2.2	43.3	46.6	18000	1.58
H7022 C-DL /HQ1	110	170	28	2.00	1.0	33	6.0	16.2	2.2	47.9	53.9	20000	2.05
H7022 AC-DL /HQ1	110	170	28	2.00	1.0	47	6.0	16.2	2.2	45.1	51.1	18000	2.05
H7024 C-DL /HQ1	120	180	28	2.00	1.0	34	6.0	16.2	2.2	58.3	64.9	20000	2.07
H7024 AC-DL /HQ1	120	180	28	2.00	1.0	49	6.0	16.2	2.2	54.8	61.5	18000	2.07

High-speed sealed angular contact ball bearings

B719 C-2RZ

Contact angle $\alpha = 15^\circ$

B719 AC-2RZ

Contact angle $\alpha = 25^\circ$

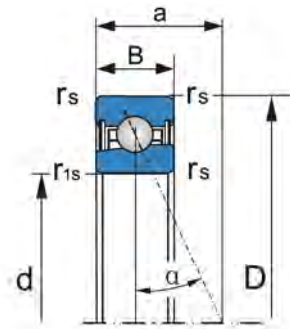

Bearing designations ZYS	Boundary dimensions						Load rating		Limiting speed	Weight
	d	D	B	r _{smin}	r _{1smin}	a	C _r	C _{or}	Greas	Kg
	mm						≈	KN		r/min
B71900 C-2RZ	10	22	6	0.30	0.10	5	1.9	1.0	90000	0.01
B71900 AC-2RZ	10	22	6	0.30	0.10	7	1.8	1.0	75000	0.01
B71901 C-2RZ	12	24	6	0.30	0.10	5	2.0	1.1	80000	0.01
B71901 AC-2RZ	12	24	6	0.30	0.10	7	1.9	1.1	67000	0.01
B71902 C-2RZ	15	28	7	0.30	0.10	6	2.2	1.4	67000	0.02
B71902 AC-2RZ	15	28	7	0.30	0.10	9	2.1	1.3	56000	0.02
B71903 C-2RZ	17	30	7	0.30	0.10	7	2.3	1.5	60000	0.02
B71903 AC-2RZ	17	30	7	0.30	0.10	9	2.2	1.4	50000	0.02
B71904 C-2RZ	20	37	9	0.30	0.15	8	3.9	2.7	50000	0.04
B71904 AC-2RZ	20	37	9	0.30	0.15	11	3.7	2.5	43000	0.04
B71905 C-2RZ	25	42	9	0.30	0.15	9	4.2	3.2	43000	0.05
B71905 AC-2RZ	25	42	9	0.30	0.15	12	3.9	3.0	36000	0.05
B71906 C-2RZ	30	47	9	0.30	0.15	10	6.3	4.9	36000	0.05
B71906 AC-2RZ	30	47	9	0.30	0.15	13	6.0	4.6	32000	0.05
B71907 C-2RZ	35	55	10	0.60	0.15	11	6.9	6.0	32000	0.08
B71907 AC-2RZ	35	55	10	0.60	0.15	15	6.5	5.6	26000	0.08
B71908 C-2RZ	40	62	12	0.60	0.15	13	7.2	6.8	28000	0.13
B71908 AC-2RZ	40	62	12	0.60	0.15	18	6.8	6.4	24000	0.13
B71909 C-2RZ	45	68	12	0.60	0.15	14	10.0	9.3	24000	0.15
B71909 AC-2RZ	45	68	12	0.60	0.15	19	9.4	8.8	22000	0.15
B71910 C-2RZ	50	72	12	0.60	0.15	14	10.3	10.1	22000	0.15
B71910 AC-2RZ	50	72	12	0.60	0.15	20	9.7	9.5	20000	0.15
B71911 C-2RZ	55	80	13	0.60	0.15	16	13.2	12.9	20000	0.20
B71911 AC-2RZ	55	80	13	0.60	0.15	22	12.4	12.2	18000	0.20
B71912 C-2RZ	60	85	13	1.00	0.30	16	13.6	13.9	19000	0.22
B71912 AC-2RZ	60	85	13	1.00	0.30	23	12.8	13.2	17000	0.22
B71913 C-2RZ	65	90	13	1.00	0.30	17	14.0	15.0	18000	0.23
B71913 AC-2RZ	65	90	13	1.00	0.30	25	13.2	14.1	15000	0.23

High-speed sealed angular contact ball bearings

B719 C-2RZ

Contact angle $\alpha = 15^\circ$

B719 AC-2RZ

Contact angle $\alpha = 25^\circ$

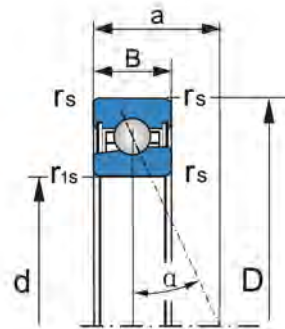

Bearing designations ZYS	Boundary dimensions						Load rating		Limiting speed	Weight Kg ≈
	d	D	B	r _{smin}	r _{1smin}	a	C _r	C _{or}	Grease r/min	
	mm						≈	KN		
B71914 C-2RZ	70	100	16	1.00	0.30	19	18.3	19.9	16000	0.38
B71914 AC-2RZ	70	100	16	1.00	0.30	28	17.3	18.6	14000	0.38
B71915 C-2RZ	75	105	16	1.00	0.30	20	18.8	21.2	16000	0.41
B71915 AC-2RZ	75	105	16	1.00	0.30	29	17.6	20.0	13000	0.41
B71916 C-2RZ	80	110	16	1.00	0.30	21	21.0	23.9	15000	0.42
B71916 AC-2RZ	80	110	16	1.00	0.30	30	19.6	22.4	13000	0.42
B71917 C-2RZ	85	120	18	1.10	0.60	23	21.9	26.0	14000	0.62
B71917 AC-2RZ	85	120	18	1.10	0.60	33	20.4	24.5	12000	0.62
B71918 C-2RZ	90	125	18	1.10	0.60	23	23.6	28.5	13000	0.64
B71918 AC-2RZ	90	125	18	1.10	0.60	34	22.4	26.5	11000	0.64
B71919 C-2RZ	95	130	18	1.10	0.60	24	24.5	30.0	12000	0.67
B71919 AC-2RZ	95	130	18	1.10	0.60	35	22.8	28.0	10000	0.67
B71920 C-2RZ	100	140	20	1.10	0.60	26	29.0	36.0	11000	0.92
B71920 AC-2RZ	100	140	20	1.10	0.60	38	27.5	33.5	9500	0.92
B71921 C-2RZ	105	145	20	1.10	0.60	27	30.0	38.0	11000	0.96
B71921 AC-2RZ	105	145	20	1.10	0.60	39	28.0	35.5	9000	0.96
B71922 C-2RZ	110	150	20	1.10	0.60	27	34.5	43.8	10000	0.98
B71922 AC-2RZ	110	150	20	1.10	0.60	40	32.5	40.5	9000	0.98
B71924 C-2RZ	120	165	22	1.10	0.60	30	36.5	48.0	9000	1.37
B71924 AC-2RZ	120	165	22	1.10	0.60	44	34.0	45.0	8000	1.37
B71926 C-2RZ	130	180	24	1.50	0.60	33	41.1	55.9	8500	1.77
B71926 AC-2RZ	130	180	24	1.50	0.60	48	38.6	52.0	7000	1.77
B71928 C-2RZ	140	190	24	1.50	0.60	34	41.9	60.0	7000	1.88
B71928 AC-2RZ	140	190	24	1.50	0.60	50	39.4	55.6	6700	1.88
B71930 C-2RZ	150	210	28	2.00	1.00	38	47.5	71.1	6700	2.94
B71930 AC-2RZ	150	210	28	2.00	1.00	56	44.7	67.0	6000	2.94
B71932C-2RZ	160	220	28	2.00	1.00	39	50.1	74.8	6000	3.11
B71932AC-2RZ	160	220	28	2.00	1.00	58	47.1	70.5	5600	3.11

High-speed sealed angular contact ball bearings

B719 C-2RZ

Contact angle $\alpha = 15^\circ$

B719 AC-2RZ

Contact angle $\alpha = 25^\circ$

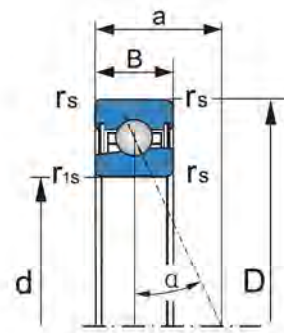

Bearing designations ZYS	Boundary dimensions						Load rating		Limiting speed	Weight
	d	D	B	r _{smin}	r _{1smin}	a	C _r	C _{or}	Greas r/min	Kg ≈
	mm						≈	KN		
B71934C-2RZ	170	230	28	2.00	1.00	41	57.7	86.8	5600	3.22
B71934AC-2RZ	170	230	28	2.00	1.00	61	54.3	81.8	5000	3.22
B71936C-2RZ	180	250	33	2.00	1.00	45	59.2	93.1	5000	4.93
B71936AC-2RZ	180	250	33	2.00	1.00	67	55.7	87.7	4800	4.93
B71938C-2RZ	190	260	33	2.00	1.00	47	75.0	116.1	4800	5.03
B71938AC-2RZ	190	260	33	2.00	1.00	69	70.6	109.4	4300	5.03
B71940C-2RZ	200	280	38	2.00	1.00	51	75.0	120.7	4500	7.26
B71940AC-2RZ	200	280	38	2.00	1.00	75	70.5	113.7	4000	7.26
B71944C-2RZ	220	300	38	2.00	1.00	54	84.6	139.6	4300	7.77
B71944AC-2RZ	220	300	38	2.00	1.00	80	79.6	131.5	3800	7.77

High-speed sealed angular contact ball bearings

B70 C-2RZ

Contact angle $\alpha = 15^\circ$

B70 AC-2RZ

Contact angle $\alpha = 25^\circ$

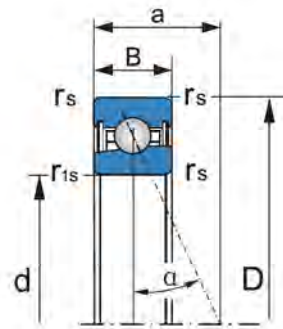

Bearing designations ZYS	Boundary dimensions						Load rating		Limiting speed	Weight
	d	D	B	r _{smin}	r _{1smin}	a	C _r	C _{or}	Greas r/min	Kg ≈
	mm					≈	KN			
B7000 C-2RZ	10	26	8	0.30	0.15	6	2.2	1.2	80000	0.02
B7000 AC-2RZ	10	26	8	0.30	0.15	8	2.1	1.2	67000	0.02
B7001 C-2RZ	12	28	8	0.30	0.15	7	2.2	1.3	70000	0.02
B7001 AC-2RZ	12	28	8	0.30	0.15	9	2.0	1.2	60000	0.02
B7002 C-2RZ	15	32	9	0.30	0.15	8	3.6	2.3	60000	0.03
B7002 AC-2RZ	15	32	9	0.30	0.15	10	3.5	2.2	50000	0.03
B7003 C-2RZ	17	35	10	0.30	0.15	8	3.8	2.5	53000	0.04
B7003 AC-2RZ	17	35	10	0.30	0.15	11	3.6	2.3	45000	0.04
B7004 C-2RZ	20	42	12	0.60	0.15	10	6.1	4.3	45000	0.08
B7004 AC-2RZ	20	42	12	0.60	0.15	13	5.8	4.1	38000	0.08
B7005 C-2RZ	25	47	12	0.60	0.15	11	6.2	4.6	38000	0.09
B7005 AC-2RZ	25	47	12	0.60	0.15	14	5.8	4.4	34000	0.09
B7006 C-2RZ	30	55	13	1.00	0.30	12	8.6	6.6	32000	0.13
B7006 AC-2RZ	30	55	13	1.00	0.30	16	8.1	6.3	28000	0.13
B7007 C-2RZ	35	62	14	1.00	0.30	13	9.2	7.8	28000	0.18
B7007 AC-2RZ	35	62	14	1.00	0.30	18	8.7	7.4	24000	0.18
B7008 C-2RZ	40	68	15	1.00	0.30	15	9.8	8.9	26000	0.22
B7008 AC-2RZ	40	68	15	1.00	0.30	20	9.3	8.4	22000	0.22
B7009 C-2RZ	45	75	16	1.00	0.30	16	12.5	11.4	24000	0.28
B7009 AC-2RZ	45	75	16	1.00	0.30	22	11.8	10.7	20000	0.28
B7010 C-2RZ	50	80	16	1.00	0.30	17	12.9	12.4	22000	0.30
B7010 AC-2RZ	50	80	16	1.00	0.30	23	12.2	11.7	18000	0.30
B7011 C-2RZ	55	90	18	1.10	0.30	19	18.6	17.8	19000	0.44
B7011 AC-2RZ	55	90	18	1.10	0.60	26	17.5	16.8	17000	0.44
B7012 C-2RZ	60	95	18	1.10	0.60	19	19.3	19.3	18000	0.47
B7012 AC-2RZ	60	95	18	1.10	0.60	27	18.2	18.2	15000	0.47
B7013 C-2RZ	65	100	18	1.10	0.60	20	19.9	20.8	17000	0.50
B7013 AC-2RZ	65	100	18	1.10	0.60	28	18.8	19.7	15000	0.50

High-speed sealed angular contact ball bearings
B70 C-2RZ
Contact angle $\alpha = 15^\circ$
B70 AC-2RZ
Contact angle $\alpha = 25^\circ$

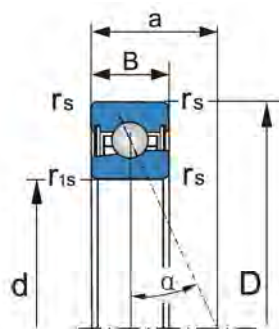

Bearing designations ZYS	Boundary dimensions						Load rating		Limiting speed	Weight
	d	D	B	r _{smin}	r _{1smin}	a	C _r	C _{or}	Greas r/min	Kg ≈
	mm					≈	KN			
B7014 C-2RZ	70	110	20	1.10	0.60	22	25.9	26.7	16000	0.69
B7014 AC-2RZ	70	110	20	1.10	0.60	31	24.4	25.2	13000	0.69
B7015 C-2RZ	75	115	20	1.10	0.60	23	26.2	27.8	15000	0.73
B7015 AC-2RZ	75	115	20	1.10	0.60	32	24.7	26.3	13000	0.73
B7016 C-2RZ	80	125	22	1.10	0.60	25	31.2	33.5	14000	0.99
B7016 AC-2RZ	80	125	22	1.10	0.60	35	29.5	31.7	12000	0.99
B7017 C-2RZ	85	130	22	1.10	0.60	25	31.6	34.9	13000	1.03
B7017 AC-2RZ	85	130	22	1.10	0.60	36	29.9	32.9	11000	1.03
B7018 C-2RZ	90	140	24	1.50	0.60	27	37.1	41.4	12000	1.35
B7018 AC-2RZ	90	140	24	1.50	0.60	39	35.1	39.1	10000	1.35
B7019 C-2RZ	95	145	24	1.50	0.60	28	37.6	43.0	11000	1.40
B7019 AC-2RZ	95	145	24	1.50	0.60	40	35.5	40.6	9500	1.40
B7020 C-2RZ	100	150	24	1.50	0.60	29	38.1	44.6	11000	1.46
B7020 AC-2RZ	100	150	24	1.50	0.60	41	36.0	42.1	9000	1.46
B7021 C-2RZ	105	160	26	2.00	1.00	31	49.1	56.3	10000	1.82
B7021 AC-2RZ	105	160	26	2.00	1.00	44	46.4	53.2	8000	1.82
B7022 C-2RZ	110	170	28	2.00	1.00	33	49.7	58.5	9500	2.31
B7022 AC-2RZ	110	170	28	2.00	1.00	47	46.9	55.3	8000	2.31
B7024 C-2RZ	120	180	28	2.00	1.00	34	51.0	62.8	8500	2.47
B7024 AC-2RZ	120	180	28	2.00	1.00	49	48.2	58.5	7500	2.47
B7026 C-2RZ	130	200	33	2.00	1.00	39	65.4	81.5	7500	3.68
B7026 AC-2RZ	130	200	33	2.00	1.00	55	61.8	77.0	6700	3.68
B7028 C-2RZ	140	210	33	2.00	1.00	40	67.1	87.0	6700	3.91
B7028 AC-2RZ	140	210	33	2.00	1.00	57	63.4	82.2	6300	3.91
B7030 C-2RZ	150	225	35	2.10	1.10	43	82.4	106.5	6000	4.71
B7030 AC-2RZ	150	225	35	2.10	1.10	61	77.8	100.6	5600	4.71
B7032 C-2RZ	160	240	38	2.10	1.10	46	84.3	113.4	5600	5.90
B7032 AC-2RZ	160	240	38	2.10	1.10	66	79.6	107.2	5000	5.90

High-speed sealed angular contact ball bearings

B70 C-2RZ

Contact angle $\alpha = 15^\circ$

B70 AC-2RZ

Contact angle $\alpha = 25^\circ$

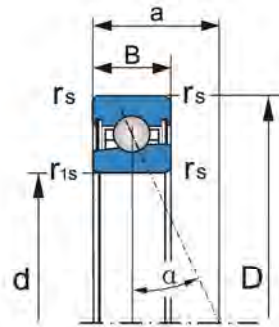

Bearing designations ZYS	Boundary dimensions						Load rating		Limiting speed	Weight
	d	D	B	r_{smin}	r_{1smin}	a	C_r	C_{or}	Grease r/min	Kg ≈
	mm						≈	KN		
B7034 C-2RZ	170	260	42	2.10	1.10	50	102.7	139.6	5300	7.94
B7034 AC-2RZ	170	260	42	2.10	1.10	71	97.0	131.9	4800	7.94
B7036 C-2RZ	180	280	46	2.10	1.10	54	104.8	148.3	4800	10.57
B7036 AC-2RZ	180	280	46	2.10	1.10	77	99.0	140.1	4300	10.57
B7038 C-2RZ	190	290	46	2.10	1.10	55	123.7	173.9	4500	10.84
B7038 AC-2RZ	190	290	46	2.10	1.10	79	116.9	164.3	4000	10.84
B7040 C-2RZ	200	310	51	2.10	1.10	60	126.4	184.4	4000	14.32
B7040 AC-2RZ	200	310	51	2.10	1.10	85	119.4	174.2	3800	14.32
B7044 C-2RZ	220	340	56	3.00	1.10	66	147.7	219.5	3800	18.82
B7044 AC-2RZ	220	340	56	3.00	1.10	93	139.5	207.4	3600	18.82

High-speed sealed angular contact ball bearings (ceramic balls)

B719 C-2RZ/HQ1

Contact angle $\alpha = 15^\circ$

B719 AC-2RZ/HQ1

Contact angle $\alpha = 25^\circ$

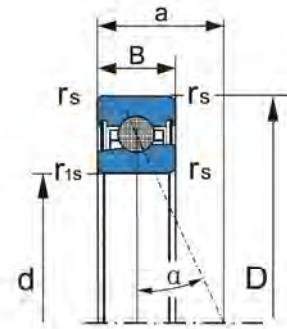

Bearing designations ZYS	Boundary dimensions						Load rating		Limiting speed	Weight
	d	D	B	r _{smin}	r _{lsmin}	a	C _r	C _{or}	Greas r/min	Kg ≈
	mm						≈	KN		
B71900 C-2RZ/HQ1	10	22	6	0.30	0.10	5	1.9	1.0	100000	0.01
B71900 AC-2RZ/HQ1	10	22	6	0.30	0.10	7	1.8	1.0	85000	0.01
B71901 C-2RZ/HQ1	12	24	6	0.30	0.10	5	2.0	1.1	90000	0.01
B71901 AC-2RZ/HQ1	12	24	6	0.30	0.10	7	1.9	1.1	75000	0.01
B71902 C-2RZ/HQ1	15	28	7	0.30	0.10	6	2.2	1.4	75000	0.02
B71902 AC-2RZ/HQ1	15	28	7	0.30	0.10	9	2.1	1.3	63000	0.02
B71903 C-2RZ/HQ1	17	30	7	0.30	0.10	7	2.3	1.5	70000	0.02
B71903 AC-2RZ/HQ1	17	30	7	0.30	0.10	9	2.2	1.4	60000	0.02
B71904 C-2RZ/HQ1	20	37	9	0.30	0.10	8	3.9	2.7	56000	0.04
B71904 AC-2RZ/HQ1	20	37	9	0.30	0.10	11	3.7	2.5	48000	0.04
B71905 C-2RZ/HQ1	25	42	9	0.30	0.15	9	4.2	3.2	48000	0.05
B71905 AC-2RZ/HQ1	25	42	9	0.30	0.15	12	3.9	3.0	40000	0.05
B71906 C-2RZ/HQ1	30	47	9	0.30	0.15	10	6.3	4.9	43000	0.05
B71906 AC-2RZ/HQ1	30	47	9	0.30	0.15	13	6.0	4.6	36000	0.05
B71907 C-2RZ/HQ1	35	55	10	0.60	0.15	11	6.9	6.0	36000	0.08
B71907 AC-2RZ/HQ1	35	55	10	0.60	0.15	15	6.5	5.6	30000	0.08
B71908 C-2RZ/HQ1	40	62	12	0.60	0.15	13	7.2	6.8	32000	0.12
B71908 AC-2RZ/HQ1	40	62	12	0.60	0.15	18	6.8	6.4	28000	0.12
B71909 C-2RZ/HQ1	45	68	12	0.60	0.15	14	10.0	9.3	28000	0.14
B71909 AC-2RZ/HQ1	45	68	12	0.60	0.15	19	9.4	8.8	24000	0.14
B71910 C-2RZ/HQ1	50	72	12	0.60	0.15	14	10.3	10.1	26000	0.14
B71910 AC-2RZ/HQ1	50	72	12	0.60	0.15	20	9.7	9.5	22000	0.14
B71911 C-2RZ/HQ1	55	80	13	1.00	0.30	16	13.2	12.9	24000	0.19
B71911 AC-2RZ/HQ1	55	80	13	1.00	0.30	22	12.4	12.2	20000	0.19
B71912 C-2RZ/HQ1	60	85	13	1.00	0.30	16	13.6	13.9	22000	0.20
B71912 AC-2RZ/HQ1	60	85	13	1.00	0.30	23	12.8	13.2	19000	0.20
B71913 C-2RZ/HQ1	65	90	13	1.00	0.30	17	14.0	15.0	20000	0.21
B71913 AC-2RZ/HQ1	65	90	13	1.00	0.30	25	13.2	14.1	18000	0.21

High-speed sealed angular contact ball bearings (ceramic balls)

B719 C-2RZ/HQ1

Contact angle $\alpha = 15^\circ$

B719 AC-2RZ/HQ1

Contact angle $\alpha = 25^\circ$

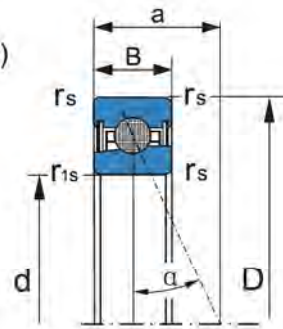

Bearing designations ZYS	Boundary dimensions						Load rating		Limiting speed	Weight
	d	D	B	r _{smin}	r _{1smin}	a	C _r	C _{or}	Greas r/min	Kg
	mm					≈	KN			≈
B71914 C-2RZ/HQ1	70	100	16	1.00	0.30	19	18.3	19.9	19000	0.36
B71914 AC-2RZ/HQ1	70	100	16	1.00	0.30	28	17.3	18.6	16000	0.36
B71915 C-2RZ/HQ1	75	105	16	1.00	0.30	20	18.8	21.2	18000	0.39
B71915 AC-2RZ/HQ1	75	105	16	1.00	0.30	29	17.6	20.0	15000	0.39
B71916 C-2RZ/HQ1	80	110	16	1.00	0.30	21	21.0	23.9	17000	0.40
B71916 AC-2RZ/HQ1	80	110	16	1.00	0.30	30	19.6	22.4	15000	0.40
B71917 C-2RZ/HQ1	85	120	18	1.10	0.60	23	21.9	26.0	16000	0.58
B71917 AC-2RZ/HQ1	85	120	18	1.10	0.60	33	20.4	24.5	13000	0.58
B71918 C-2RZ/HQ1	90	125	18	1.10	0.60	23	23.6	28.5	15000	0.60
B71918 AC-2RZ/HQ1	90	125	18	1.10	0.60	34	22.4	26.5	13000	0.60
B71919 C-2RZ/HQ1	95	130	18	1.10	0.60	24	24.5	30.0	14000	0.62
B71919 AC-2RZ/HQ1	95	130	18	1.10	0.60	35	22.8	28.0	12000	0.62
B71920 C-2RZ/HQ1	100	140	20	1.10	0.60	26	29.0	36.0	13000	0.86
B71920 AC-2RZ/HQ1	100	140	20	1.10	0.60	38	27.5	33.5	11000	0.86
B71921 C-2RZ/HQ1	105	145	20	1.10	0.60	27	30.0	38.0	12000	0.89
B71921 AC-2RZ/HQ1	105	145	20	1.10	0.60	39	28.0	35.5	11000	0.89
B71922 C-2RZ/HQ1	110	150	20	1.10	0.60	27	34.5	43.8	12000	0.90
B71922 AC-2RZ/HQ1	110	150	20	1.10	0.60	40	32.5	41.4	10000	0.90
B71924 C-2RZ/HQ1	120	165	22	1.10	0.60	30	36.5	48.0	11000	1.28
B71924 AC-2RZ/HQ1	120	165	22	1.10	0.60	44	34.0	45.0	9000	1.28
B71926 C-2RZ/HQ1	130	180	24	1.50	0.60	33	41.1	55.9	9000	1.68
B71926 AC-2RZ/HQ1	130	180	24	1.50	0.60	48	38.6	52.0	8000	1.68
B71928 C-2RZ/HQ1	140	190	24	1.50	0.60	34	41.9	60.0	8000	1.79
B71928 AC-2RZ/HQ1	140	190	24	1.50	0.60	50	39.4	55.6	7500	1.79
B71930 C-2RZ/HQ1	150	210	28	2.00	1.00	38	47.5	71.1	7500	2.83
B71930 AC-2RZ/HQ1	150	210	28	2.00	1.00	56	44.7	67.0	6700	2.83
B71932 C-2RZ/HQ1	160	220	28	2.00	1.00	39	50.1	74.8	6700	2.98
B71932 AC-2RZ/HQ1	160	220	28	2.00	1.00	58	47.1	70.5	6300	2.98

High-speed sealed angular contact ball bearings (ceramic balls)
B719 C-2RZ/HQ1
Contact angle $\alpha = 15^\circ$
B719 AC-2RZ/HQ1
Contact angle $\alpha = 25^\circ$

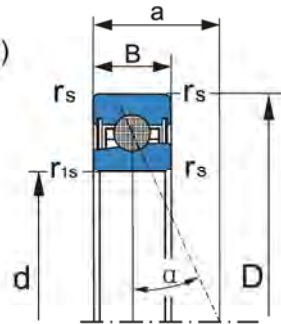

Bearing designations ZYS	Boundary dimensions						Load rating		Limiting speed	Weight
	d	D	B	r _{smin}	r _{ismin}	a	C _r	C _{or}	Greas r/min	Kg
	mm						≈	KN		
B71934 C-2RZ/HQ1	170	230	28	2.00	1.00	41	57.7	86.8	6300	3.07
B71934 AC-2RZ/HQ1	170	230	28	2.00	1.00	61	54.3	81.8	5600	3.07
B71936 C-2RZ/HQ1	180	250	33	2.00	1.00	45	59.2	93.1	5600	4.77
B71936 AC-2RZ/HQ1	180	250	33	2.00	1.00	67	55.7	87.7	5300	4.77
B71938 C-2RZ/HQ1	190	260	33	2.00	1.00	47	75.0	116.1	5300	4.80
B71938 AC-2RZ/HQ1	190	260	33	2.00	1.00	69	70.6	109.4	4800	4.80
B71940 C-2RZ/HQ1	200	280	38	2.00	1.00	51	75.0	120.7	5000	7.02
B71940 AC-2RZ/HQ1	200	280	38	2.00	1.00	75	70.5	113.7	4500	7.02
B71944 C-2RZ/HQ1	220	300	38	2.00	1.00	54	84.6	139.6	4800	7.47
B71944 AC-2RZ/HQ1	220	300	38	2.00	1.00	80	79.6	131.5	4300	7.47

High-speed sealed angular contact ball bearings (ceramic balls)
 B70 C-2RZ/HQ1
 Contact angle $\alpha = 15^\circ$
 B70 AC-2RZ/HQ1
 Contact angle $\alpha = 25^\circ$

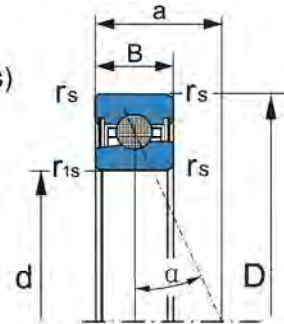

Bearing designations ZYS	Boundary dimensions						Load rating		Limiting speed	Weight
	d	D	B	r _{smin}	r _{1smin}	a	C _r	C _{or}	Greas	Kg
	mm						≈	KN		r/min
B7000 C-2RZ/HQ1	10	26	8	0.30	0.15	6	2.2	1.2	90000	0.02
B7000 AC-2RZ/HQ1	10	26	8	0.30	0.15	8	2.1	1.2	75000	0.02
B7001 C-2RZ/HQ1	12	28	8	0.30	0.15	7	2.2	1.3	80000	0.02
B7001 AC-2RZ/HQ1	12	28	8	0.30	0.15	9	2.0	1.2	70000	0.02
B7002 C-2RZ/HQ1	15	32	9	0.30	0.15	8	3.6	2.3	70000	0.03
B7002 AC-2RZ/HQ1	15	32	9	0.30	0.15	10	3.5	2.2	60000	0.03
B7003 C-2RZ/HQ1	17	35	10	0.30	0.15	8	3.8	2.5	63000	0.04
B7003 AC-2RZ/HQ1	17	35	10	0.30	0.15	11	3.6	2.3	53000	0.04
B7004 C-2RZ/HQ1	20	42	12	0.60	0.15	10	6.1	4.3	53000	0.08
B7004 AC-2RZ/HQ1	20	42	12	0.60	0.15	13	5.8	4.1	45000	0.08
B7005 C-2RZ/HQ1	25	47	12	0.60	0.15	11	6.2	4.6	45000	0.09
B7005 AC-2RZ/HQ1	25	47	12	0.60	0.15	14	5.8	4.4	38000	0.09
B7006 C-2RZ/HQ1	30	55	13	1.00	0.30	12	8.6	6.6	38000	0.13
B7006 AC-2RZ/HQ1	30	55	13	1.00	0.30	16	8.1	6.3	32000	0.13
B7007 C-2RZ/HQ1	35	62	14	1.00	0.30	13	9.2	7.8	34000	0.18
B7007 AC-2RZ/HQ1	35	62	14	1.00	0.30	18	8.7	7.4	28000	0.18
B7008 C-2RZ/HQ1	40	68	15	1.00	0.30	15	9.8	8.9	30000	0.20
B7008 AC-2RZ/HQ1	40	68	15	1.00	0.30	20	9.3	8.4	26000	0.20
B7009 C-2RZ/HQ1	45	75	16	1.00	0.30	16	12.5	11.4	26000	0.26
B7009 AC-2RZ/HQ1	45	75	16	1.00	0.30	22	11.8	10.7	24000	0.26
B7010 C-2RZ/HQ1	50	80	16	1.00	0.30	17	12.9	12.4	24000	0.28
B7010 AC-2RZ/HQ1	50	80	16	1.00	0.30	23	12.2	11.7	22000	0.28
B7011 C-2RZ/HQ1	55	90	18	1.10	0.60	19	18.6	17.8	22000	0.41
B7011 AC-2RZ/HQ1	55	90	18	1.10	0.60	26	17.5	16.8	19000	0.41
B7012 C-2RZ/HQ1	60	95	18	1.10	0.60	19	19.3	19.3	20000	0.43
B7012 AC-2RZ/HQ1	60	95	18	1.10	0.60	27	18.2	18.2	18000	0.43
B7013 C-2RZ/HQ1	65	100	18	1.10	0.60	20	19.9	20.8	20000	0.46
B7013 AC-2RZ/HQ1	65	100	18	1.10	0.60	28	18.8	19.7	17000	0.46

High-speed sealed angular contact ball bearings (ceramic balls)

B70 C-2RZ/HQ1

Contact angle $\alpha = 15^\circ$

B70 AC-2RZ/HQ1

Contact angle $\alpha = 25^\circ$

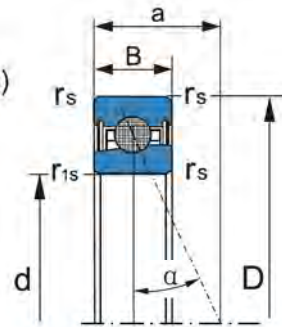

Bearing designations ZYS	Boundary dimensions						Load rating		Limiting speed	Weight
	d	D	B	r_{smin}	r_{1smin}	a	C_r	C_{or}	Greas r/min	Kg ≈
	mm						≈	KN		
B7014 C-2RZ/HQ1	70	110	20	1.10	0.60	22	25.9	26.7	18000	0.64
B7014 AC-2RZ/HQ1	70	110	20	1.10	0.60	31	24.4	25.2	15000	0.64
B7015 C-2RZ/HQ1	75	115	20	1.10	0.60	23	26.2	27.8	17000	0.67
B7015 AC-2RZ/HQ1	75	115	20	1.10	0.60	32	24.7	26.3	15000	0.67
B7016 C-2RZ/HQ1	80	125	22	1.10	0.60	25	31.2	33.5	16000	0.90
B7016 AC-2RZ/HQ1	80	125	22	1.10	0.60	35	29.5	31.7	13000	0.90
B7017 C-2RZ/HQ1	85	130	22	1.10	0.60	25	31.6	34.9	15000	0.94
B7017 AC-2RZ/HQ1	85	130	22	1.10	0.60	36	29.9	32.9	13000	0.94
B7018 C-2RZ/HQ1	90	140	24	1.50	0.60	27	37.1	41.4	14000	1.24
B7018 AC-2RZ/HQ1	90	140	24	1.50	0.60	39	35.1	39.1	12000	1.24
B7019 C-2RZ/HQ1	95	145	24	1.50	0.60	28	37.6	43.0	13000	1.26
B7019 AC-2RZ/HQ1	95	145	24	1.50	0.60	40	35.5	40.6	11000	1.26
B7020 C-2RZ/HQ1	100	150	24	1.50	0.60	29	38.1	44.6	12000	1.34
B7020 AC-2RZ/HQ1	100	150	24	1.50	0.60	41	36.0	42.1	11000	1.34
B7021 C-2RZ/HQ1	105	160	26	2.00	1.00	31	49.1	56.3	12000	1.66
B7021 AC-2RZ/HQ1	105	160	26	2.00	1.00	44	46.4	53.2	10000	1.66
B7022 C-2RZ/HQ1	110	170	28	2.00	1.00	33	49.7	58.5	11000	2.16
B7022 AC-2RZ/HQ1	110	170	28	2.00	1.00	47	46.9	55.3	9000	2.16
B7024 C-2RZ/HQ1	120	180	28	2.00	1.00	34	51.0	62.8	10000	2.21
B7024 AC-2RZ/HQ1	120	180	28	2.00	1.00	49	48.2	58.5	8500	2.21
B7026 C-2RZ/HQ1	130	200	33	2.00	1.00	39	65.4	81.5	9000	3.52
B7026 AC-2RZ/HQ1	130	200	33	2.00	1.00	55	61.0	77.0	7500	3.52
B7028 C-2RZ/HQ1	140	210	33	2.00	1.00	40	67.1	87.0	7500	3.73
B7028 AC-2RZ/HQ1	140	210	33	2.00	1.00	57	63.4	82.2	7000	3.73
B7030 C-2RZ/HQ1	150	225	35	2.10	2.10	43	82.4	106.5	6700	4.46
B7030 AC-2RZ/HQ1	150	225	35	2.10	2.10	61	77.8	100.6	6300	4.46
B7032 C-2RZ/HQ1	160	240	38	2.10	1.10	46	84.3	113.4	6300	5.64
B7032 AC-2RZ/HQ1	160	240	38	2.10	1.10	66	79.6	107.2	5600	5.64

High-speed sealed angular contact ball bearings (ceramic balls)
 B70 C-2RZ/HQ1
 Contact angle $\alpha = 15^\circ$
 B70 AC-2RZ/HQ1
 Contact angle $\alpha = 25^\circ$

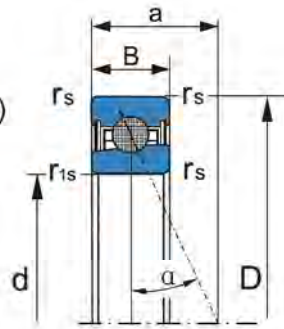

Bearing designations ZYS	Boundary dimensions						Load rating		Limiting speed	Weight
	d	D	B	r_{smin}	r_{1smin}	a	C_r	C_{or}	Greas r/min	Kg
	mm						≈	KN		r/min
B7034 C-2RZ/HQ1	170	260	42	2.10	1.10	50	102.7	139.6	6000	7.95
B7034 AC-2RZ/HQ1	170	260	42	2.10	1.10	71	97.0	131.9	5300	7.95
B7036 C-2RZ/HQ1	180	280	46	2.10	1.10	54	104.8	148.3	5300	10.20
B7036 AC-2RZ/HQ1	180	280	46	2.10	1.10	77	99.0	140.1	4800	10.20
B7038 C-2RZ/HQ1	190	290	46	2.10	1.10	55	123.7	173.9	5000	10.36
B7038 AC-2RZ/HQ1	190	290	46	2.10	1.10	79	116.9	164.3	4500	10.36
B7040 C-2RZ/HQ1	200	310	51	2.10	1.10	60	126.4	184.4	4500	13.81
B7040 AC-2RZ/HQ1	200	310	51	2.10	1.10	85	119.4	174.2	4300	13.81
B7044 C-2RZ/HQ1	220	340	56	3.00	1.10	66	147.7	219.5	4300	18.16
B7044 AC-2RZ/HQ1	220	340	56	3.00	1.10	93	139.5	207.4	4000	18.16

High-speed spindle bearings
B70 C
Contact angle $\alpha = 15^\circ$

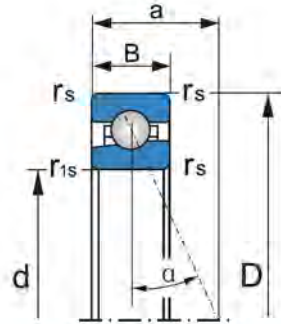

Bearing designations ZYS	Boundary dimensions						Load rating		Limiting speed		Weight Kg ≈
	d	D	B	r _{smin}	r _{1smin}	a	C _r	C _{0r}	Grease	Oil	
	mm					≈	KN		r/min		
B7000 C	10	26	8	0.30	0.15	6	3.0	1.2	80000	130000	0.02
B7001 C	12	28	8	0.30	0.15	7	3.3	1.3	70000	110000	0.02
B7002 C	15	32	9	0.30	0.15	8	3.6	1.6	60000	90000	0.03
B7003 C	17	35	10	0.30	0.15	8	3.9	1.7	53000	80000	0.04
B7004 C	20	42	12	0.60	0.15	10	5.7	2.7	45000	67000	0.06
B7005 C	25	47	12	0.60	0.15	11	7.4	3.8	38000	56000	0.08
B7006 C	30	55	13	1.00	0.30	12	9.1	4.8	32000	48000	0.11
B7007 C	35	62	14	1.00	0.30	13	10.9	6.0	28000	43000	0.15
B7008 C	40	68	15	1.00	0.30	15	12.9	7.4	26000	40000	0.19
B7009 C	45	75	16	1.00	0.30	16	15.0	9.0	24000	38000	0.24
B7010 C	50	80	16	1.00	0.30	17	15.9	10.0	22000	36000	0.26
B7011 C	55	90	18	1.10	0.60	19	19.9	12.9	19000	32000	0.41
B7012 C	60	95	18	1.10	0.60	19	20.4	13.6	18000	30000	0.44

High-speed spindle bearings (ceramic balls)
B70 C/HQ1
Contact angle $\alpha = 15^\circ$

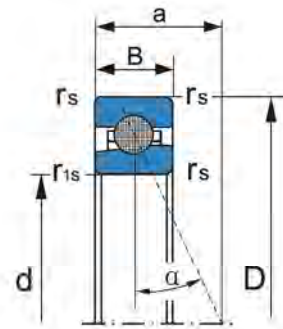

Bearing designations ZYS	Boundary dimensions						Load rating		Limiting speed		Weight Kg ≈
	d	D	B	r _{smin}	r _{1smin}	a	C _r	C _{or}	Grease	Oil	
	mm						≈	KN		r/min	
B7000 C/HQ1	10	26	8	0.30	0.15	6	3.0	1.2	100000	160000	0.02
B7001 C/HQ1	12	28	8	0.30	0.15	7	3.3	1.3	85000	130000	0.02
B7002 C/HQ1	15	32	9	0.30	0.15	8	3.6	1.6	75000	110000	0.03
B7003 C/HQ1	17	35	10	0.30	0.15	8	3.9	1.7	67000	100000	0.04
B7004 C/HQ1	20	42	12	0.60	0.15	10	5.7	2.7	56000	85000	0.06
B7005 C/HQ1	25	47	12	0.60	0.15	11	7.4	3.8	45000	67000	0.08
B7006 C/HQ1	30	55	13	1.00	0.30	12	9.1	4.8	38000	56000	0.11
B7007 C/HQ1	35	62	14	1.00	0.30	13	10.9	6.0	34000	53000	0.15
B7008 C/HQ1	40	68	15	1.00	0.30	15	12.9	7.4	32000	48000	0.19
B7009 C/HQ1	45	75	16	1.00	0.30	16	15.0	9.0	30000	45000	0.24
B7010 C/HQ1	50	80	16	1.00	0.30	17	15.9	10.0	26000	43000	0.26
B7011 C/HQ1	55	90	18	1.10	0.60	19	19.9	12.9	22000	38000	0.41
B7012 C/HQ1	60	95	18	1.10	0.60	19	20.4	13.6	21000	36000	0.44

Designation of cylindrical roller bearings

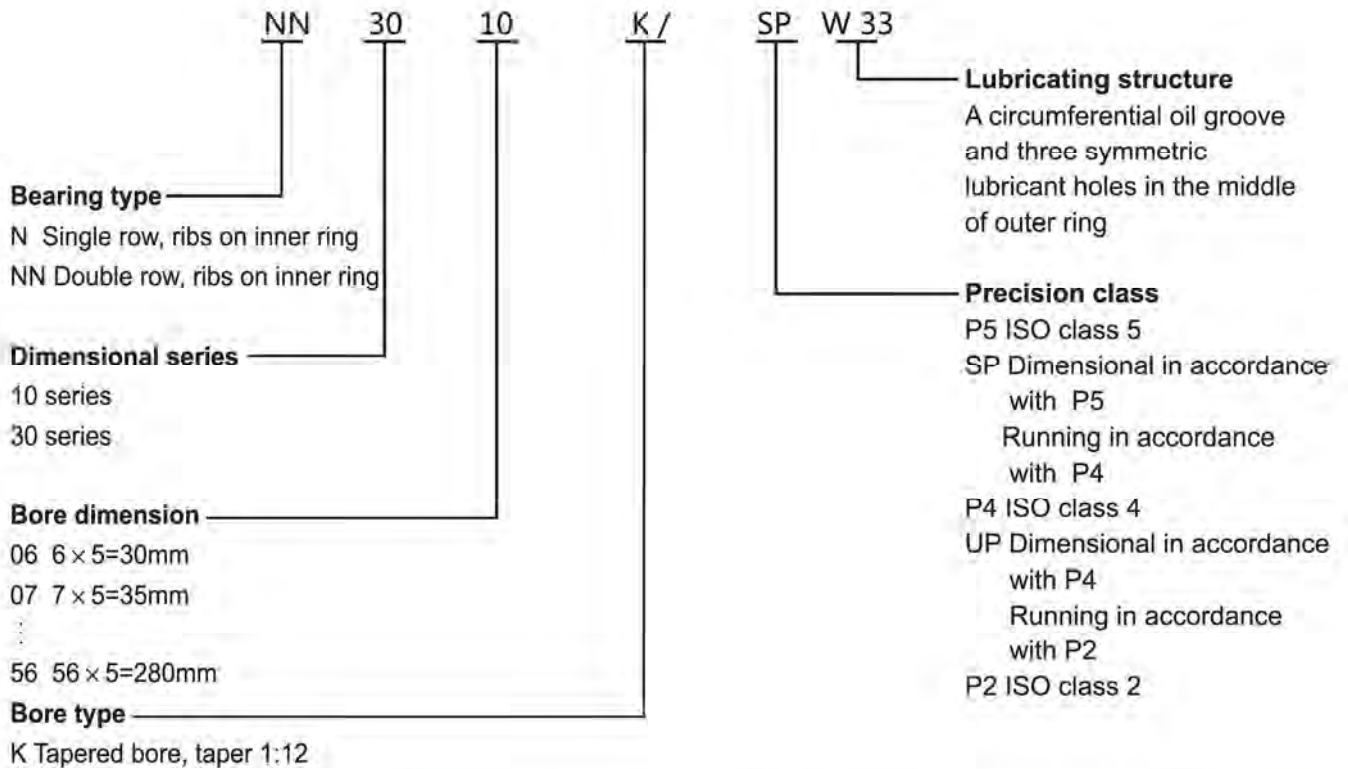

Radial clearance of cylindrical roller bearings(tapered bore)

μ m

d mm		1		2	
From	Up to	min	max	min	max
24	30	15	25	25	35
30	40	15	25	25	40
40	50	17	30	30	45
50	65	20	35	35	50
65	80	25	40	40	60
80	100	35	55	45	70
100	120	40	60	50	80
120	140	45	70	60	90
140	160	50	75	65	100
160	180	55	85	75	110
180	200	60	90	80	120
200	225	60	95	90	135
225	250	65	100	100	150
250	280	75	110	110	165

Cylindrical roller bearings
 Single row N10K series, taper 1:12

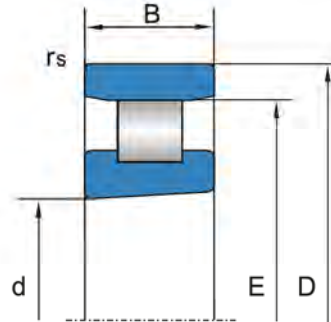

Bearing designations ZYS	Boundary dimensions					Load rating		Limiting speed		Radial rigidity R_r KN/ μ m	Weight Kg ≈
	d	D	B	r_{smin}	E	C_r	C_{or}	Grease	Oil		
	mm					KN		r/min			
N1006 K	30	55	13	0.6	48.5	18.6	18	19000	22000	0.3	0.13
N1007 K	35	62	14	0.6	55	23.6	24.5	16000	18000	0.4	0.17
N1008 K	40	68	15	0.6	61	27.5	29	15000	17000	0.4	0.22
N1009 K	45	75	16	0.6	67.5	32.5	35.5	13000	15000	0.5	0.27
N1010 K	50	80	16	0.6	72.5	36	41.5	12000	14000	0.5	0.29
N1011 K	55	90	18	1.0	80.5	41.5	50	11000	13000	0.6	0.44
N1012 K	60	95	18	1.0	85.5	44	55	10000	12000	0.7	0.47
N1013 K	65	100	18	1.0	90.5	45	58.5	9500	11000	0.7	0.49
N1014 K	70	110	20	1.0	100	64	81	9000	10000	0.8	0.69
N1015 K	75	115	20	1.0	105	65.5	85	8500	9500	0.8	0.72
N1016 K	80	125	22	1.0	113.5	76.5	98	7500	8500	0.9	0.98
N1017 K	85	130	22	1.0	118.5	78	104	7500	8500	0.9	1.04
N1018 K	90	140	24	1.1	127	93	125	6700	7500	1.0	1.34
N1019 K	95	145	24	1.1	132	96.5	129	6300	7000	1.0	1.40
N1020 K	100	150	24	1.1	137	98	134	6000	6700	1.1	1.46
N1021 K	105	160	26	1.1	145.5	112	153	5600	6300	1.1	1.82
N1022 K	110	170	28	1.1	155	140	190	4800	6000	1.2	2.30
N1024 K	120	180	28	1.1	165	150	208	5000	5600	1.3	2.47
N1026 K	130	200	33	1.1	182	180	250	4300	4800	1.4	3.72
N1028 K	140	210	33	1.1	192	183	265	4000	4500	1.4	3.94
N1030 K	150	225	35	1.5	205.5	208	310	3800	4300	1.6	4.75
N1032 K	160	240	38	1.5	220	245	355	3400	3800	1.6	5.79
N1034 K	170	260	42	2.1	237	300	430	3200	3600	1.8	7.77
N1036 K	180	280	46	2.1	255	360	520	3000	3400	1.9	10.2
N1038 K	190	290	46	2.1	265	365	550	2800	3200	2.0	10.6
N1040 K	200	310	51	2.1	281	400	600	2600	3000	2.1	14.0
N1044 K	220	340	56	3.0	310	510	765	2400	2800	2.3	17.9
N1048 K	240	360	56	3.0	330	540	850	2200	2600	2.5	19.3
N1052 K	260	400	65	4.0	364	655	1020	1900	2200	2.7	28.6
N1056 K	280	420	65	4.0	384	680	1100	1800	2000	2.9	30.9

Cylindrical Roller Bearings
Double row NN30K series, taper 1:12

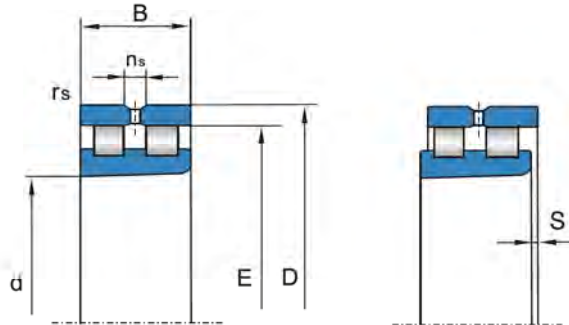

Bearing designations ZYS	Boundary dimensions					Load rating		Limiting speed		Radial rigidity R_r KN/ μ m	Weight Kg ≈		
	d	D	B	r_{smin}	E	C_r	C_{or}	Grease	Oil				
	mm					KN		r/min					
NN3006 K	30	55	19	1.0	48.5	4.8	1.4	29	34	16000	19000	0.6	0.19
NN3007 K	35	62	20	1.0	55	4.8	1.4	35.5	44	14000	17000	0.7	0.25
NN3008 K	40	68	21	1.0	61	4.8	1.4	45	58.5	12000	15000	0.9	0.31
NN3009 K	45	75	23	1.0	67.5	4.8	1.7	54	72	11000	14000	1.0	0.40
NN3010 K	50	80	23	1.0	72.5	4.8	1.7	57	80	10000	13000	1.1	0.41
NN3011 K	55	90	26	1.1	81	4.8	1.9	72	100	9000	11000	1.3	0.65
NN3012 K	60	95	26	1.1	86.1	4.8	1.9	75	110	8500	10000	1.4	0.67
NN3013 K	65	100	26	1.1	91	4.8	1.9	76.5	116	8000	9500	1.4	0.74
NN3014 K	70	110	30	1.1	100	6.5	2.3	98	150	7000	8500	1.6	1.07
NN3015 K	75	115	30	1.1	105	6.5	2.3	100	156	6700	8000	1.7	1.13
NN3016 K	80	125	34	1.1	113	6.5	2.5	120	186	6300	7500	1.8	1.56
NN3017 K	85	130	34	1.1	118	6.5	2.5	125	200	6000	7000	1.9	1.64
NN3018 K	90	140	37	1.5	127	6.5	2.5	140	224	5600	6700	2.0	2.13
NN3019 K	95	145	37	1.5	132	6.5	2.5	143	236	5300	6300	2.1	2.23
NN3020 K	100	150	37	1.5	137	6.5	2.5	146	245	5300	6300	2.1	2.32
NN3021 K	105	160	41	2.0	146	6.5	2.6	190	310	4800	5600	2.3	2.96
NN3022 K	110	170	45	2.0	155	6.5	2.8	220	360	4500	5300	2.5	3.76
NN3024 K	120	180	46	2.0	165	6.5	3.1	232	390	4300	5000	2.7	4.10
NN3026 K	130	200	52	2.0	182	9.5	3.3	290	500	3800	4500	2.9	6.04
NN3028 K	140	210	53	2.0	192	9.5	3.3	300	520	3600	4300	3.0	6.48
NN3030 K	150	225	56	2.1	206	9.5	3.7	335	585	3400	4000	3.3	7.88
NN3032 K	160	240	60	2.1	219	9.5	4.2	375	670	3200	3800	3.5	9.57
NN3034 K	170	260	67	2.1	236	9.5	4.5	450	800	3000	3600	3.7	13.0
NN3036 K	180	280	74	2.1	255	12.2	4.8	570	1000	2800	3400	4.0	17.0
NN3038 K	190	290	75	2.1	265	12.2	4.8	585	1040	2600	3200	4.1	18.0
NN3040 K	200	310	82	2.1	282	12.2	5.3	655	1200	2400	3000	4.4	23.0
NN3044 K	220	340	90	3.0	310	15	5.5	800	1460	2200	2800	4.7	32.9
NN3048 K	240	360	92	3.0	330	15	6	850	1560	2000	2600	5.1	36.0
NN3052 K	260	400	104	4.0	364	15	6.5	1060	2000	1900	2400	5.6	48.0
NN3056 K	280	420	106	4.0	384	15	6.8	1080	2080	1800	2200	5.8	51.7

Designation of double-direction angular contact thrust ball bearings

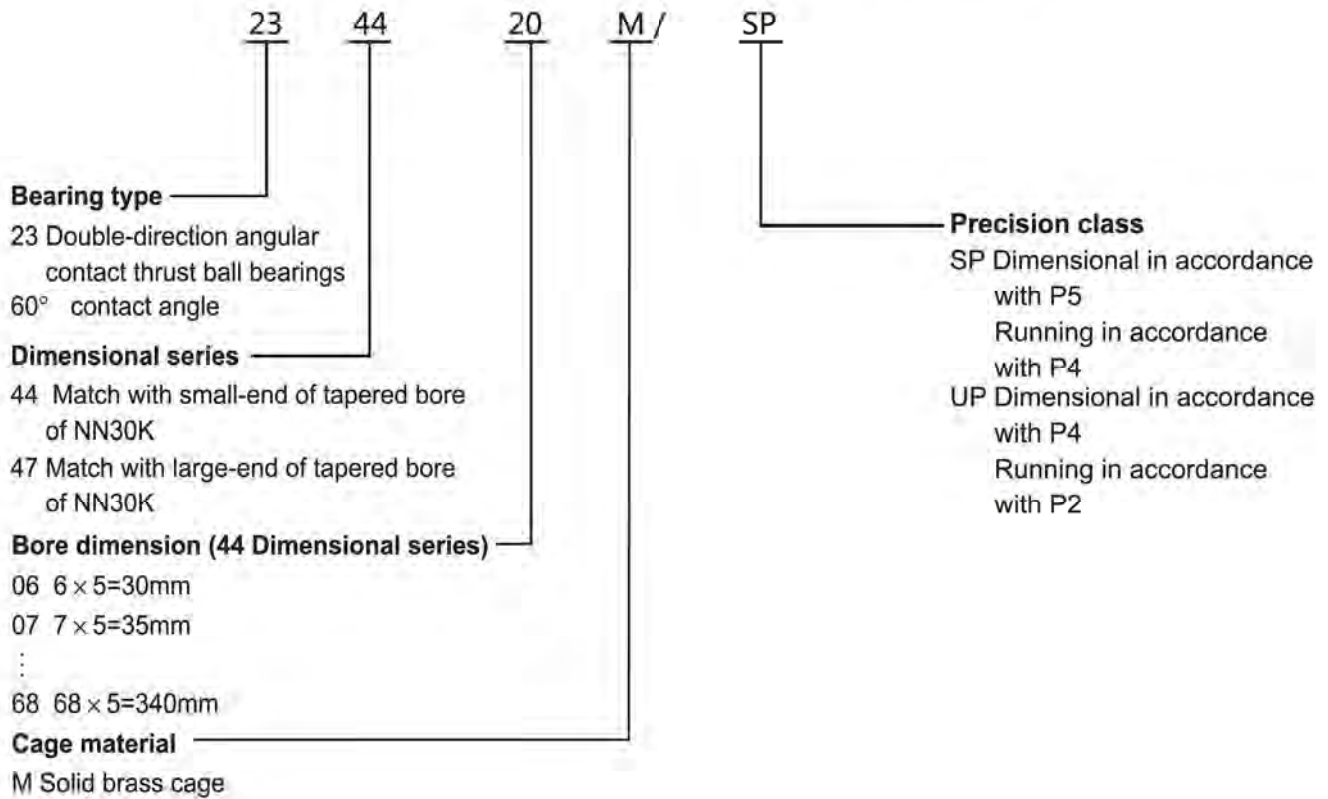

Double-direction angular contact thrust ball bearings
2344、2347series
Contact angle $\alpha = 60^\circ$

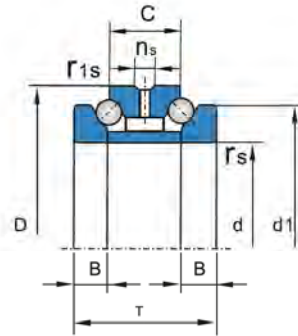

Bearing designations ZYS	Boundary dimensions									Load rating		Limiting speed		Weight kg ≈
	d	D	d _{lmax}	T	C	B	r _{1smin}	r _{1smin}	n _s	C _a	C _{oA}	Grease	Oil	
	mm									KN		r/min		
234406 M	30	55	47	32	16	8	1.0	0.15	4.8	14.3	24	11000	16000	0.29
234706 M	32	55	47	32	16	8	1.0	0.15	4.8	14.3	24	11000	16000	0.27
234407 M	35	62	53	34	17	8.5	1.0	0.15	4.8	17.6	31.5	9500	14000	0.38
234707 M	37	62	53	34	17	8.5	1.0	0.15	4.8	17.6	31.5	9500	14000	0.35
234408 M	40	68	58.5	36	18	9	1.0	0.15	4.8	20.8	38	8500	12000	0.46
234708 M	42	68	58.5	36	18	9	1.0	0.15	4.8	20.8	38	8500	12000	0.42
234409 M	45	75	65	38	19	9.5	1.0	0.15	4.8	23.2	45	7500	10000	0.57
234709 M	47	75	65	38	19	9.5	1.0	0.15	4.8	23.2	45	7500	10000	0.53
234410 M	50	80	70	38	19	9.5	1.0	0.15	4.8	24	49	7000	9500	0.62
234710 M	52	80	70	38	19	9.5	1.0	0.15	4.8	24	49	7000	9500	0.58
234411 M	55	90	78	44	22	11	1.1	0.3	6.5	34	67	6300	8500	0.94
234711 M	57	90	78	44	22	11	1.1	0.3	6.5	34	67	6300	8500	0.88
234412 M	60	95	83	44	22	11	1.1	0.3	6.5	33.5	68	6000	8000	1.01
234712 M	62	95	83	44	22	11	1.1	0.3	6.5	33.5	68	6000	8000	0.94
234413 M	65	100	88	44	22	11	1.1	0.3	6.5	36	76.5	5600	7500	1.08
234713 M	67	100	88	44	22	11	1.1	0.3	6.5	36	76.5	5600	7500	1.01
234414 M	70	110	97	48	24	12	1.1	0.3	6.5	42.5	93	7000	7000	1.49
234714 M	73	110	97	48	24	12	1.1	0.3	6.5	42.5	93	7000	7000	1.36
234415 M	75	115	102	48	24	12	1.1	0.3	6.5	44	100	5000	6700	1.57
234715 M	78	115	102	48	24	12	1.1	0.3	6.5	44	100	5000	6700	1.43
234416 M	80	125	110	54	27	13.5	1.1	0.3	6.5	52	120	4500	6000	2.16
234716 M	83	125	110	54	27	13.5	1.1	0.3	6.5	52	120	4500	6000	1.98
234417 M	85	130	115	54	27	13.5	1.1	0.3	9.5	52	125	4500	6000	2.25
234717 M	88	130	115	54	27	13.5	1.1	0.3	9.5	52	125	4500	6000	2.07
234418 M	90	140	123	60	30	15	1.5	0.3	9.5	61	146	4000	5300	2.92
234718 M	93	140	123	60	30	15	1.5	0.3	9.5	61	146	4000	5300	2.71
234419 M	95	145	128	60	30	15	1.5	0.3	9.5	61	150	4000	5300	3.04
234719 M	98	145	128	60	30	15	1.5	0.3	9.5	61	150	4000	5300	2.83
234420 M	100	150	133	60	30	15	1.5	0.3	9.5	62	156	3800	5000	3.17
234720 M	103	150	133	60	30	15	1.5	0.3	9.5	62	156	3800	5000	2.95
234421 M	105	160	142	66	33	16.5	2.0	0.6	9.5	69.5	176	3600	4800	4.07
234721 M	109	160	142	66	33	16.5	2.0	0.6	9.5	69.5	176	3600	4800	3.73
234422 M	110	170	150	72	36	18	2.0	0.6	9.5	90	224	3400	4500	5.19

Double-direction angular contact thrust ball bearings
2344、2347series
Contact angle $\alpha = 60^\circ$

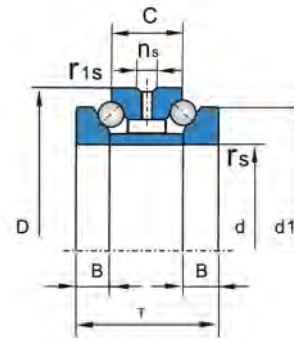

Bearing designations ZYS	Boundary dimensions									Load rating		Limiting speed		Weight kg ≈
	d	D	d _{lmax}	T	C	B	r _{1smin}	r _{1smin}	n _s	C _a	C _{oa}	Grease	Oil	
	mm									KN		r/min		
234722 M	114	170	150	72	36	18	2.0	0.6	9.5	90	224	3400	4500	4.79
234424 M	120	180	160	72	36	18	2.0	0.6	9.5	93	240	3200	4300	5.56
234724 M	124	180	160	72	36	18	2.0	0.6	9.5	93	240	3200	4300	5.14
234426 M	130	200	177	84	42	21	2.0	0.6	12.2	118	300	2800	3800	8.28
234726 M	135	200	177	84	42	21	2.0	0.6	12.2	118	300	2800	3800	7.58
234428 M	140	210	187	84	42	21	2.1	0.6	12.2	122	320	2600	3600	8.78
234728 M	145	210	187	84	42	21	2.1	0.6	12.2	122	320	2600	3600	8.07
234430 M	150	225	200	90	45	22.5	2.1	0.6	15	132	355	2600	3600	10.8
234730 M	155	225	200	90	45	22.5	2.1	0.6	15	132	355	2600	3600	9.95
234432 M	160	240	212	96	48	24	2.1	0.6	15	156	415	2400	3400	12.9
234732 M	165	240	212	96	48	24	2.1	0.6	15	156	415	2400	3400	12.0
234434 M	170	260	230	108	54	27	2.1	0.6	15	193	520	2200	3200	17.7
234734 M	176	260	230	108	54	27	2.1	0.6	15	193	520	2200	3200	16.3
234436 M	180	280	248	120	60	30	2.1	0.6	15	216	585	2000	3000	23.4
234736 M	187	280	248	120	60	30	2.1	0.6	15	216	585	2000	3000	21.5
234438 M	190	290	258	120	60	30	2.1	0.6	15	224	630	1900	2800	24.7
234738 M	197	290	258	120	60	30	2.1	0.6	15	224	630	1900	2800	22.6
234440 M	200	310	274	132	66	33	2.1	0.6	15	265	720	1800	2600	31.5
234740 M	207	310	274	132	66	33	2.1	0.6	15	265	720	1800	2600	29.2
234444 M	220	340	304	144	72	36	3.0	1.1	15	315	900	1600	2200	41.7
234744 M	228	340	304	144	72	36	3.0	1.1	15	315	900	1600	2200	38.5
234448 M	240	360	322	144	72	36	3.0	1.1	15	325	965	1500	2000	43.8
234748 M	248	360	322	144	72	36	3.0	1.1	15	325	965	1500	2000	40.4
234452 M	260	400	354	164	82	41	4.0	1.5	17.7	380	1180	1400	1900	64.5
234752 M	269	400	354	164	82	41	4.0	1.5	17.7	380	1180	1400	1900	59.7
234456 M	280	420	374	164	82	41	4.0	1.5	17.7	390	1270	1300	1800	69.0
234756 M	289	420	374	164	82	41	4.0	1.5	17.7	390	1270	1300	1800	63.8
234460 M	300	460	406	190	95	47.5	4.0	1.5	17.7	450	1530	1200	1700	98.4
234760 M	310	460	406	190	95	47.5	4.0	1.5	17.7	450	1530	1200	1700	91.2
234464 M	320	480	426	190	95	47.5	4.0	1.5	17.7	455	1630	1200	1700	102
234764 M	330	480	426	190	95	47.5	4.0	1.5	17.7	455	1630	1200	1700	94.9
234468 M	340	520	459	212	106	53	4.0	1.5	17.7	540	2000	1100	1600	138
234768 M	350	520	459	212	106	53	4.0	1.5	17.7	540	2000	1100	1600	129

Designation of high-speed angular contact thrust ball bearings

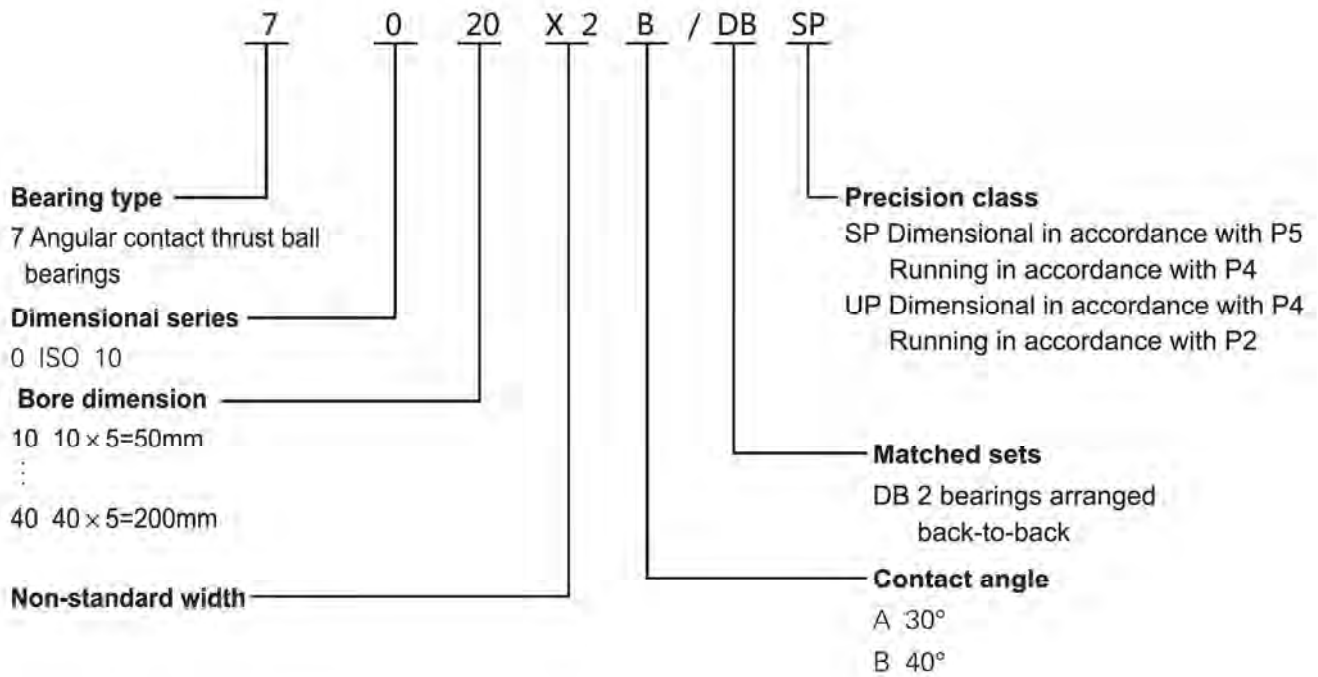

High-speed angular contact thrust ball bearings
 70X2 A/DBseries
 Contact angle $\alpha = 30^\circ$

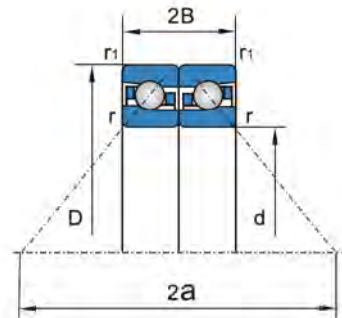

Bearing designations ZYS	Boundary dimensions						Load rating		Limiting speed		Weight Kg ≈
	d	D	2B	r _{1min}	r _{1smin}	2a	C _a	C _{0a}	Grease	Oil	
	mm					≈	KN		r/min		
7010 X2 A/DB	50	80	28.5	1.0	0.6	52	19.2	42.5	10500	14000	0.27
7011 X2 A/DB	55	90	33	1.1	0.6	58.5	23.8	54.0	9500	12500	0.40
7012 X2 A/DB	60	95	33	1.1	0.6	61	24.7	59.0	9000	12000	0.43
7013 X2 A/DB	65	100	33	1.1	0.6	64	25.5	64.0	8500	11000	0.46
7014 X2 A/DB	70	110	36	1.1	0.6	70	35.0	84.0	8000	10000	0.62
7015 X2 A/DB	75	115	36	1.1	0.6	73	35.5	88.0	7000	9000	0.65
7016 X2 A/DB	80	125	40.5	1.1	0.6	79.5	41.5	105	7000	9000	0.91
7017 X2 A/DB	85	130	40.5	1.1	0.6	82.5	42.0	109	6300	8000	0.95
7018 X2 A/DB	90	140	45	1.5	1.0	89	55.5	142	6000	7500	1.25
7019 X2 A/DB	95	145	45	1.5	1.0	92	56.0	148	6000	7500	1.30
7020 X2 A/DB	100	150	45	1.5	1.0	94.5	57.0	154	5300	7000	1.35
7021 X2 A/DB	105	160	49.5	2.0	1.0	101	64.5	177	5000	6700	1.72
7022 X2 A/DB	110	170	54	2.0	1.0	108	73.0	201	4800	6300	2.21
7024 X2 A/DB	120	180	54	2.0	1.0	114	75.0	217	4500	6000	2.37
7026 X2 A/DB	130	200	63	2.0	1.0	127	94.5	262	4000	5300	3.54
7028 X2 A/DB	140	210	63	2.0	1.0	132	103	305	3800	5000	3.78
7030 X2 A/DB	150	225	67.5	2.1	1.1	142	121	360	3800	5000	4.59
7032 X2 A/DB	160	240	72	2.1	1.1	151	131	395	3600	4800	5.58
7034 X2 A/DB	170	260	81	2.1	1.1	165	154	470	3400	4500	7.84
7036 X2 A/DB	180	280	90	2.1	1.1	178	197	590	3200	4300	10.2
7038 X2 A/DB	190	290	90	2.1	1.1	184	200	615	3000	4000	10.7
7040 X2 A/DB	200	310	99	2.1	1.1	197	222	680	2600	3600	13.8

High-speed angular contact thrust ball bearings
70X2 B/DB series
Contact angle $\alpha = 40^\circ$

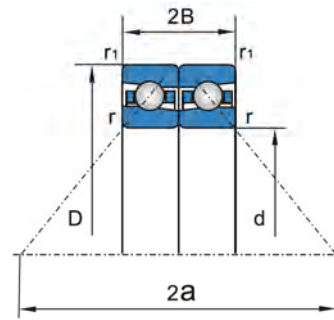

Bearing designations ZYS	Boundary dimensions						Load rating		Limiting speed		Weight Kg ≈
	d	D	2B	r _{1min}	r _{1smin}	2a	C _a	C _{oa}	Grease	Oil	
	mm						≈	KN		r/min	
7010X2 B/DB	50	80	28.5	1.0	0.6	69	22.3	48.5	9000	12000	0.27
7011X2 B/DB	55	90	33	1.1	0.6	77.5	28.2	61.5	8500	11000	0.40
7012X2 B/DB	60	95	33	1.1	0.6	81.5	29.3	67.0	8000	10000	0.43
7013X2 B/DB	65	100	33	1.1	0.6	85.5	30.5	72.5	7500	9500	0.46
7014X2 B/DB	70	110	36	1.1	0.6	93.5	41.5	95.5	7000	9000	0.62
7015X2 B/DB	75	115	36	1.1	0.6	97.5	42.0	100	6300	8500	0.65
7016X2 B/DB	80	125	40.5	1.1	0.6	106	49.5	119	6000	8000	0.91
7017X2 B/DB	85	130	40.5	1.1	0.6	110	50.0	124	5600	7500	0.95
7018X2 B/DB	90	140	45	1.5	1.0	119	65.5	161	5000	7000	1.25
7019X2 B/DB	95	145	45	1.5	1.0	123	66.5	168	4800	6300	1.30
7020X2 B/DB	100	150	45	1.5	1.0	127	67.5	175	4500	6000	1.35
7021X2 B/DB	105	160	49.5	2.0	1.0	136	76.5	201	4300	5600	1.72
7022X2 B/DB	110	170	54	2.0	1.0	144	86.5	228	4000	5300	2.21
7024X2 B/DB	120	180	54	2.0	1.0	153	89.0	246	3800	5000	2.37
7026X2 B/DB	130	200	63	2.0	1.0	170	112	299	3400	4500	3.54
7028X2 B/DB	140	210	63	2.0	1.0	178	122	345	3200	4300	3.78
7030X2 B/DB	150	225	67.5	2.1	1.1	191	143	410	3200	4300	4.59
7032X2 B/DB	160	240	72	2.1	1.1	204	155	450	3000	4000	5.58
7034X2 B/DB	170	260	81	2.1	1.1	221	182	535	2800	3800	7.84
7036X2 B/DB	180	280	90	2.1	1.1	238	234	670	2600	3600	10.2
7038X2 B/DB	190	290	90	2.1	1.1	246	238	700	2400	3200	10.7
7040X2 B/DB	200	310	99	2.1	1.1	263	263	770	2000	3000	13.8

Designation of tapered roller bearings

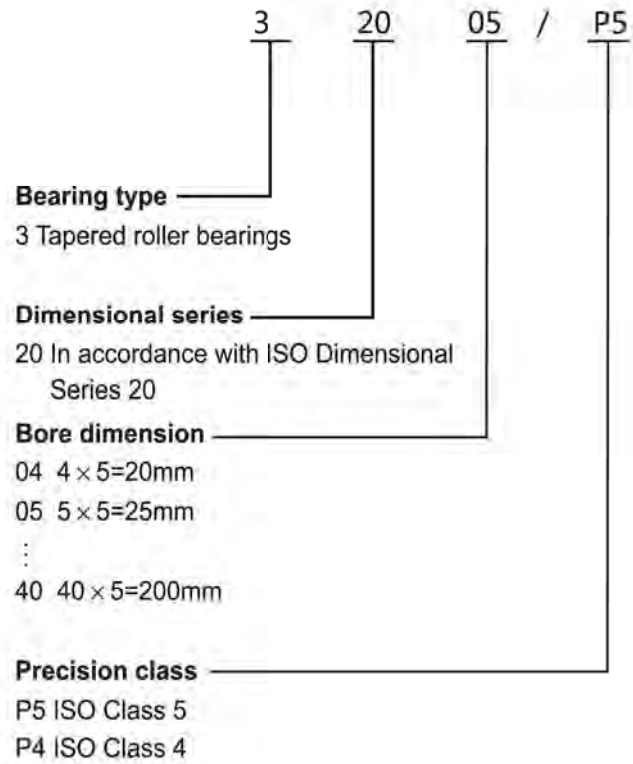

Tapered roller bearings
320series

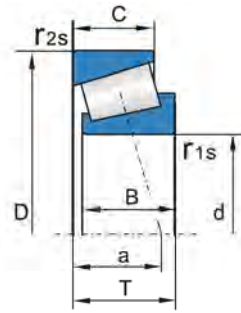

Bearing designations ZYS	Boundary dimensions								Load rating		Limiting speed		Weight Kg ≈
	d	D	B	C	T	r1smin	r2smin	a	C _r	C _{or}	Grease	Oil	
	mm								≈	KN		r/min	
32004	20	42	15	12	15	0.6	0.6	10	24	29	8500	12000	0.10
32005	25	47	15	11.5	15	0.6	0.6	12	26.5	34	8000	11000	0.10
32006	30	55	17	13	17	1.0	1.0	14	39	47.5	6700	9000	0.17
32007	35	62	18	14	18	1.0	1.0	15	46.5	58.5	6000	8000	0.22
32008	40	68	19	14.5	19	1.0	1.0	15	54	71	5300	7000	0.29
32009	45	75	20	15.5	20	1.0	1.0	17	61	86.5	4800	6300	0.33
32010	50	80	20	15.5	20	1.0	1.0	18	64	95	4500	6000	0.42
32011	55	90	23	17.5	23	1.5	1.5	20	81.5	118	4000	5300	0.58
32012	60	95	23	17.5	23	1.5	1.5	21	83	125	3800	5000	0.63
32013	65	100	23	17.5	23	1.5	1.5	23	83	129	3400	4500	0.63
32014	70	110	25	19	25	1.5	1.5	24	106	163	3200	4300	0.97
32015	75	115	25	19	25	1.5	1.5	25	108	170	3000	4000	0.93
32016	80	125	29	22	29	1.5	1.5	27	137	212	2600	3600	1.24
32017	85	130	29	22	29	1.5	1.5	28	143	228	2400	3400	1.31
32018	90	140	32	24	32	2.0	1.5	30	166	255	2200	3200	1.69
32019	95	145	32	24	32	2.0	1.5	32	173	275	2200	3200	1.79
32020	100	150	32	24	32	2.0	1.5	33	176	285	2000	3000	1.93
32021	105	160	35	26	35	2.5	2.0	35	204	335	1900	2800	2.33
32022	110	170	38	29	38	2.5	2.0	37	240	400	1800	2600	2.96
32024	120	180	38	29	38	2.5	2.0	40	250	425	1700	2400	3.28
32026	130	200	45	34	45	2.5	2.0	44	335	560	1600	2200	5.05
32028	140	210	45	34	45	2.5	2.0	46	345	610	1600	2200	5.18
32030	150	225	48	36	48	3.0	2.5	50	390	695	1500	2000	6.31
32032	160	240	51	38	51	3.0	2.5	53	425	750	1300	1800	7.78
32034	170	260	57	43	57	3.0	2.5	57	465	800	1200	1700	10.6
32036	180	280	64	48	64	3.0	2.5	60	630	1100	1100	1600	14.2
32038	190	290	64	48	64	3.0	2.5	63	640	1140	950	1400	14.8
32040	200	310	70	53	70	3.0	2.5	67	765	1370	900	1300	18.9

Designation of ZYS ball screw support bearings(standard metric)

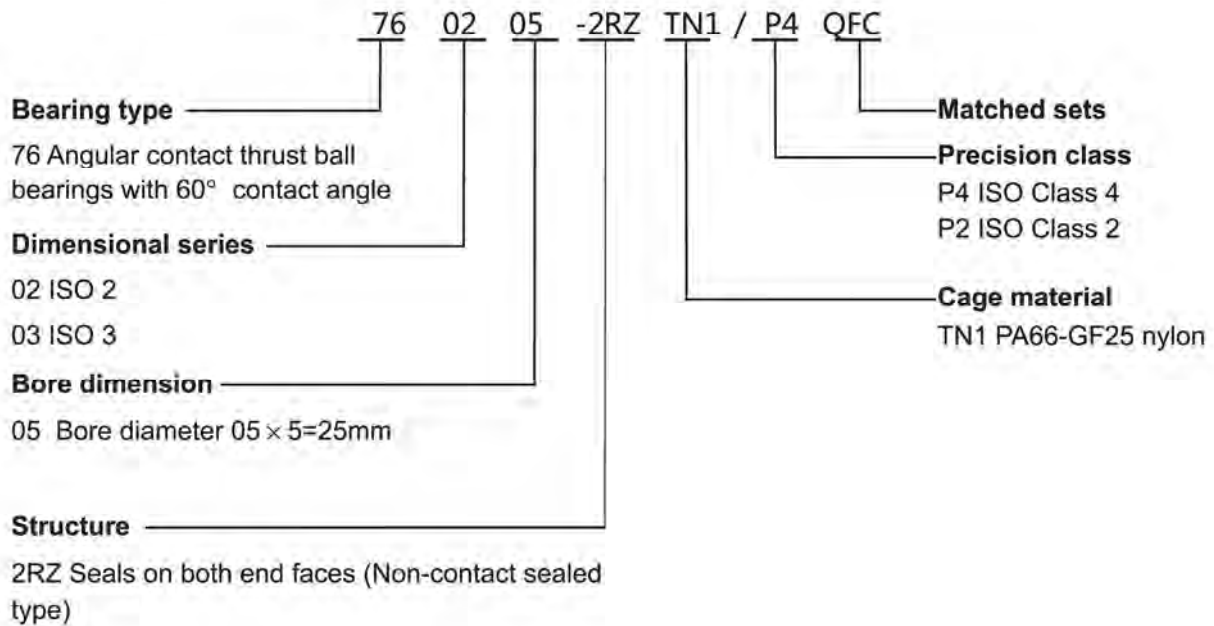

Designation of ZYS ball screw support bearings(non-standard series)

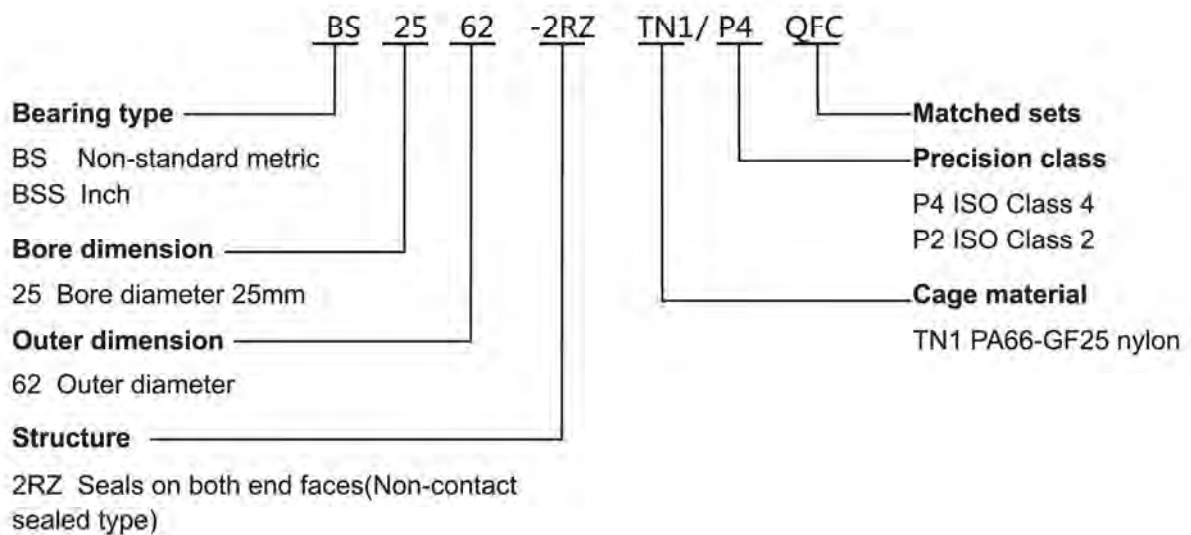

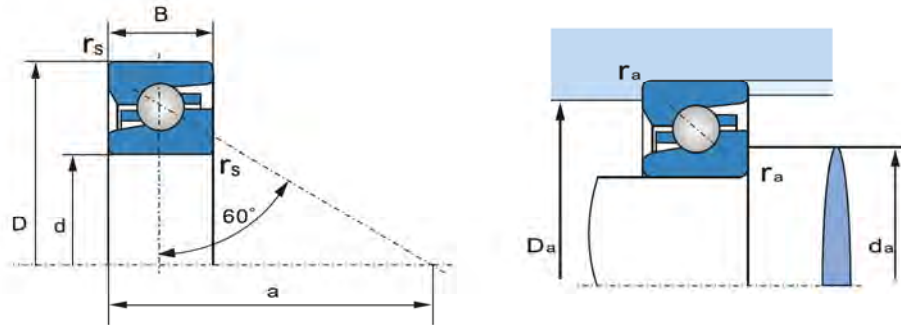

7602 standard metric series

Bearing designations ZYS	Boundary dimensions					Reference mounting dimensions			Load rating		Limiting speed		Weight kg ≈
						d _a	D _a	r _a			Grease	Oil	
	d	D	B	r _{smin}	a	h12	H12	max	C _a	C _{0a}	r/min		
	mm					≈			KN				
760201TN1	12	32	10	0.6	24	17.0	27.0	0.6	11.6	12.5	17000	24000	0.04
760202TN1	15	35	11	0.6	27	20.5	30.0	0.6	12.5	15	15000	20000	0.05
760203TN1	17	40	12	0.6	31	23.0	34.5	0.6	16.6	20	13000	18000	0.07
760204TN1	20	47	14	1.0	36	27.5	39.5	1.0	19.3	25	12000	17000	0.13
760205TN1	25	52	15	1.0	41	32.0	45.0	1.0	22	30.5	11000	16000	0.16
760206TN1	30	62	16	1.0	48	39.5	52.5	1.0	26	39	9000	13000	0.24
760207TN1	35	72	17	1.1	55	46.5	60.5	1.1	30	50	8000	11000	0.34
760208TN1	40	80	18	1.1	62	53.5	69.5	1.1	37.5	64	7000	9500	0.44
760209TN1	45	85	19	1.1	66	57.0	73.0	1.1	38	68	6700	9000	0.50
760210TN1	50	90	20	1.1	71	63.0	79.0	1.1	39	75	6300	8500	0.57
760211TN1	55	100	21	1.5	78	69.5	85.5	1.5	40.5	81.5	6000	8000	0.75
760212TN1	60	110	22	1.5	86	77.0	96.0	1.5	56	112	5000	6700	0.96
760213TN1	65	120	23	1.5	92	84.0	103.0	1.5	57	122	4800	6300	1.20
760214TN1I	70	125	24	1.5	96	87.0	108.0	1.5	65.5	137	4500	6000	1.32
760215TN1	75	130	25	1.5	101	93.5	114.5	1.5	67	150	4300	5600	1.45
760216TN1	80	140	26	2.0	108	100.0	122.0	2.0	76.5	175	4000	5300	1.76
760217TN1	85	150	28	2.0	116	107.0	131.0	2.0	86.5	196	3800	5000	2.19
760218TN1	90	160	30	2.0	123	113.5	138.5	2.0	98	224	3600	4800	2.69
760219TN1	95	170	32	2.1	131	119.5	146.5	2.1	110	255	3400	4500	3.26
760220TN1	100	180	34	2.1	138	125.5	154.5	2.1	122	285	3200	4300	3.91
760222TN1	110	200	38	2.1	153	139.0	171.0	2.1	146	355	2800	3800	5.5
760224TN1	120	215	40	2.1	165	150.0	185.0	2.1	176	425	2600	3600	6.5
760226TN1	130	230	40	3.0	176	162.5	197.0	3.0	180	455	2400	3400	7.4

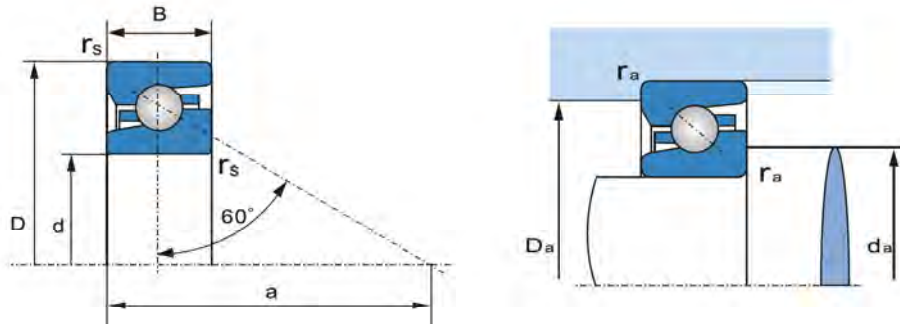

7603 standard metric series

Bearing designations ZYS	Boundary dimensions					Reference mounting dimensions			Load rating		Limiting speed		Weight kg ≈
						d _a	D _a	r _a					
	d	D	B	r _{smin}	a	h12	H12	max	C _a	C _{0a}	Grease	Oil	
	mm					≈			KN		r/min		
760304TN1	20	52	15	1.1	39	30.5	43.5	1.1	24.5	32	11000	16000	0.17
760305TN1	25	62	17	1.1	46	38.0	52.0	1.1	28.5	41.5	9000	13000	0.28
760306TN1	30	72	19	1.1	53	45.0	61.0	1.1	34.5	55	8000	11000	0.41
760307TN1	35	80	21	1.5	60	51.0	67.0	1.5	36.5	61	7000	9500	0.55
760307X3TN1	35	90	23	1.5	68	56.5	75.7	1.5	50	83	6300	8500	0.81
760308TN1	40	90	23	1.5	68	56.5	75.7	1.5	50	83	6300	8500	0.76
760309TN1	45	100	25	1.5	75	64.5	85.5	1.5	58.5	104	5600	7500	1.02
760309X3TN1	45	110	27	2.0	83	72.0	94.0	2.0	69.5	127	5000	6700	1.41
760310TN1	50	110	27	2.0	83	72.0	94.0	2.0	69.5	127	5000	6700	1.33
760311TN1	55	120	29	2.0	90	77.0	101.0	2.0	78	146	4800	6300	1.69
760312TN1	60	130	31	2.1	98	82.5	107.5	2.1	88	166	4500	6000	2.12
760313TN1	65	140	33	2.1	105	91.5	118.5	2.1	100	196	4000	5300	2.60
760314TN1	70	150	35	2.1	113	95.5	124.5	2.1	110	220	3800	5000	3.16
760315TN1	75	160	37	2.1	120	105.5	135.5	2.1	125	255	3600	4800	3.79
760316TN1	80	170	39	2.1	128	111.0	143.0	2.1	137	285	3400	4500	4.50
760317TN1	85	180	41	3.0	135	116.0	151.0	3.0	160	325	3200	4300	5.29
760318TN1	90	190	43	3.0	143	122.5	157.5	3.0	163	345	3000	4000	6.17
760319TN1	95	200	45	3.0	150	130.0	165.0	3.0	163	360	3000	4000	7.15
760320TN1	100	215	47	3.0	160	140.0	178.0	3.0	193	430	2600	3600	8.73
760322TN1	110	240	50	3.0	176	154.5	200.0	3.0	250	560	2400	3400	11.8
760324TN1	120	260	55	3.0	192	165.0	210.0	3.0	265	620	2200	3200	14.6
760326TN1	130	280	58	3.0	206	181.0	229.0	3.0	290	695	2000	3000	18.7

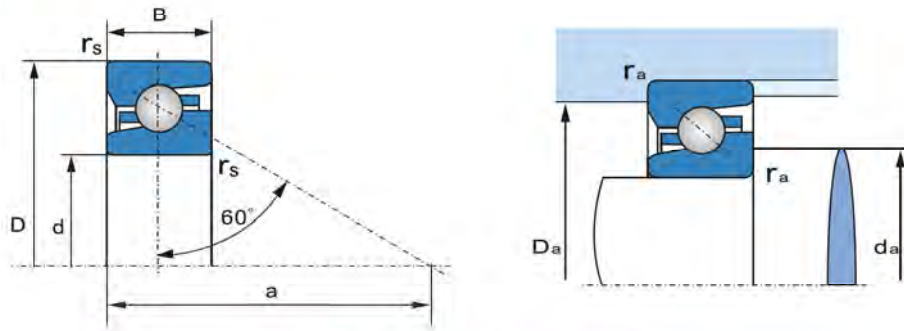

BS non-standard metric series

Bearing designations ZYS	Boundary dimensions					Reference mounting dimensions			Load rating		Limiting speed		Weight kg ≈
						d _a	D _a	r _a			Grease	Oil	
	d	D	B	r _{smin}	a	h12	H12	max	C _a	C _{oa}	r/min		
mm	≈							KN					
BS 1547TN1	15	47	15	1.0	35	27.5	39.5	1.0	21.5	27	12000	17000	0.14
BS 1747TN1	17	47	15	1.0	35	27.5	39.5	1.0	21.5	27	12000	17000	0.14
BS 2047TN1	20	47	15	1.0	37	27.5	39.5	1.0	19.3	25	12000	17000	0.13
BS 2562TN1	25	62	15	1.0	46	38.0	52.0	1.0	28.5	41.5	9000	13000	0.24
BS 3062TN1	30	62	15	1.0	48	39.5	52.5	1.0	26	39	9000	13000	0.23
BS 3072TN1	30	72	15	1.0	52	45.0	61.0	1.1	31	54	8000	11000	0.35
BS 3572TN1	35	72	15	1.0	54	46.5	60.5	1.1	30	50	8000	11000	0.30
BS 4072TN1	40	72	15	1.0	56	49.0	62.5	1.1	28	49	8000	11000	0.26
BS 4090TN1	40	90	20	1.5	67	56.5	75.5	1.5	50	83	6300	8500	0.65
BS 4575TN1	45	75	15	1.0	60	52.0	68.0	1.0	28.5	52	7500	10000	0.26
BS 45100TN1	45	100	20	1.5	74	64.5	85.5	1.5	58.5	104	5600	7500	0.81
BS 50100TN1	50	100	20	1.5	76	64.5	85.5	1.5	58.5	104	5600	7500	0.75
BS 5590TN1	55	90	15	1.0	70	65.0	80.0	1.0	32.5	65.5	6300	8500	0.38
BS 55100TN1	55	100	20	1.5	77	69.5	85.5	1.5	40.5	81.5	6000	8000	0.75
BS 55120TN1	55	120	20	1.5	86	77.0	97.5	2.0	60	116	5000	6700	1.18
BS 60120TN1	60	120	20	1.5	88	79.5	100.5	1.5	61	120	4800	6300	1.11
BS 75110TN1	75	110	15	1.5	88	85.0	99.5	1.5	35.5	83	5000	6700	0.75
BS 100150TN1	100	150	22.5	2.0	120	114.5	135.0	2.0	69.5	173	3800	5000	1.37

BSS inch series

Bearing designations ZYS	Boundary dimensions					Reference mounting dimensions			Load rating		Limiting speed		Weight kg ≈
						d _a	D _a	r _a			Grease	Oil	
	d	D	B	r _{smin}	a	h12	H12	max	C _a	C _{oa}	r/min		
mm	≈							KN					
BSS 2047TN1	20.000	47	15.875	1.0	38	27.5	39.5	1.0	19.3	25	12000	17000	0.13
BSS 2362TN1	23.838	62	15.875	1.0	45	38.0	52.0	1.0	28.5	41.5	9000	13000	0.24
BSS 3872TN1	38.100	72	15.875	1.0	56	49.0	62.5	1.1	28	49	8000	11000	0.26
BSS 4476TN1	44.475	76.2	15.875	1.0	60	52.0	68.0	1.0	28.5	52	7500	10000	0.26
BSS 5790TN1	57.150	90	15.875	1.0	72	65.0	80.0	1.0	32.5	65.5	6300	8500	0.38
BSS 76110TN1	76.200	110	15.875	1.5	88	85.0	99.5	1.5	35.5	83	5000	6700	0.75
BSS 101145TN1	101.600	145	22.225	1.5	118	114.5	132.0	2.0	69.5	173	3800	5000	1.37

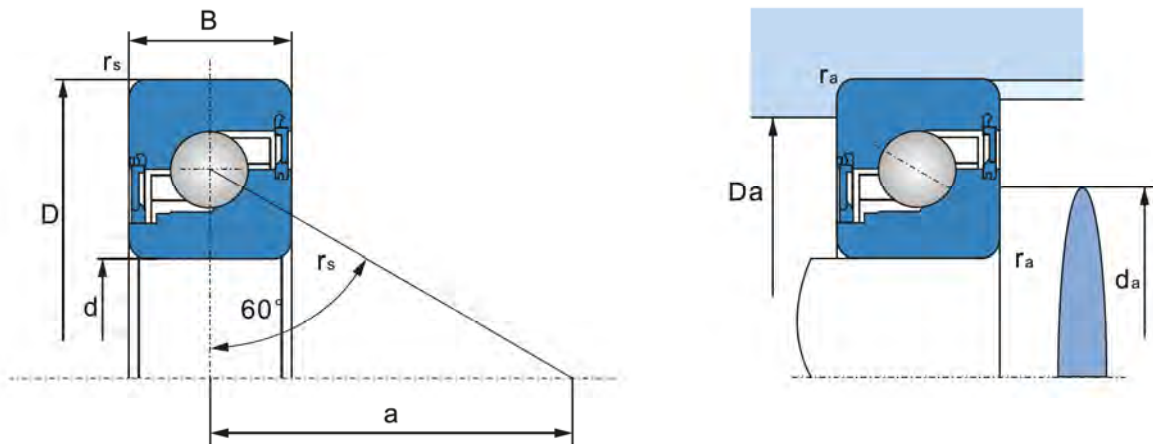

Standard metric series(sealed structure)

Bearing designations ZYS	Boundary dimensions					Reference mounting dimensions			Load rating		Limiting speed	Weight
						d _a	D _a	r _a				
	d	D	B	r _{smin}	a	h12	H12	max	C _a	C _{0a}	Grease	kg
mm ≈									KN		r/min	≈
760201-2RZ TN1	12	32	10	0.6	24	17.0	27.0	0.6	11.6	12.5	17000	0.04
760202-2RZ TN1	15	35	11	0.6	27	20.5	30.0	0.6	12.5	15	15000	0.05
760203-2RZ TN1	17	40	12	0.6	31	23.0	34.5	0.6	16.6	20	13000	0.07
760204-2RZ TN1	20	47	14	1.0	36	27.5	39.5	1.0	19.3	25	12000	0.13
760205-2RZ TN1	25	52	15	1.0	42	32.0	45.0	1.0	22	30.5	11000	0.16
760206-2RZ TN1	30	62	16	1.0	48	39.5	52.5	1.0	26	39	9000	0.24
760207-2RZ TN1	35	72	17	1.1	55	46.5	60.5	1.1	30	50	8000	0.34
760208-2RZ TN1	40	80	18	1.1	62	53.5	69.5	1.1	37.5	64	7000	0.44
760209-2RZ TN1	45	85	19	1.1	66	57.0	73.0	1.1	38	68	6700	0.50
760210-2RZ TN1	50	90	20	1.1	71	63.0	79.0	1.1	39	75	6300	0.57
760211-2RZ TN1	55	100	21	1.5	78	69.5	85.5	1.5	40.5	81.5	6000	0.75
760212-2RZ TN1	60	110	22	1.5	86	77.0	96.0	1.5	56	112	5000	0.96
760213-2RZ TN1	65	120	23	1.5	92	84.0	103.0	1.5	57	122	4800	1.20
760214-2RZ TN1	70	125	24	1.5	96	87.0	108.0	1.5	65.5	137	4500	1.32
760215-2RZ TN1	75	130	25	1.5	101	93.5	114.5	1.5	67	150	4300	1.45
760216-2RZ TN1	80	140	26	2.0	108	100.0	122.0	2.0	76.5	175	4000	1.76
760217-2RZ TN1	85	150	28	2.0	116	107.0	131.0	2.0	86.5	196	3800	2.19
760218-2RZ TN1	90	160	30	2.0	123	113.5	138.5	2.0	98	224	3600	2.69
760219-2RZ TN1	95	170	32	2.1	131	119.5	146.5	2.1	110	255	3400	3.26
760220-2RZ TN1	100	180	34	2.1	138	125.5	154.5	2.1	122	285	3200	3.91
760222-2RZ TN1	110	200	38	2.1	153	139.0	171.0	2.1	146	355	2800	5.5
760224-2RZ TN1	120	215	40	2.1	165	150.0	185.0	2.1	176	425	2600	6.5
760226-2RZ TN1	130	230	40	3.0	176	162.5	197.0	3.0	180	455	2400	7.4

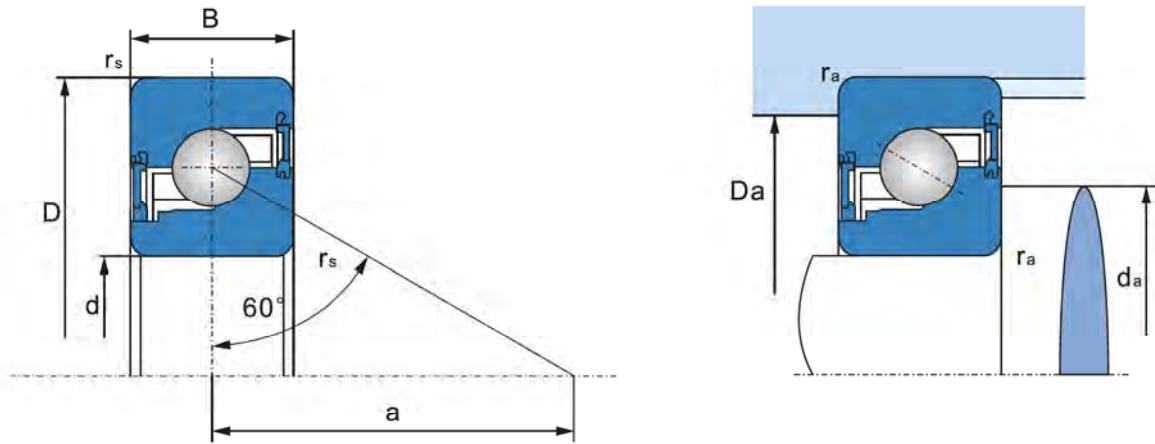

7603 Standard metric series(sealed structure)

Bearing designations ZYS	Boundary dimensions					Reference mounting dimensions			Load rating		Limiting speed	Weight kg ≈
						d _a	D _a	r _a				
	d	D	B	r _{smin}	a	h12	H12	max	C _a	C _{0a}	Grease r/min	
mm					≈			KN				
760304-2RZ TN1	20	52	15	1.1	39	30.5	43.5	1.1	24.5	32	11000	0.17
760305-2RZ TN1	25	62	17	1.1	46	38.0	52.0	1.1	28.5	41.5	9000	0.28
760306-2RZ TN1	30	72	19	1.1	53	45.0	61.0	1.1	34.5	55	8000	0.41
760307-2RZ TN1	35	80	21	1.5	60	51.0	67.0	1.5	36.5	61	7000	0.55
760307X3-2RZ TN1	35	90	23	1.5	68	56.5	75.7	1.5	50	83	6300	0.81
760308-2RZ TN1	40	90	23	1.5	68	56.5	75.7	1.5	50	83	6300	0.76
760309-2RZ TN1	45	100	25	1.5	75	64.5	85.5	1.5	58.5	104	5600	1.02
760309X3-2RZ TN1	45	110	27	2.0	83	72.0	94.0	2.0	69.5	127	5000	1041
760310-2RZ TN1	50	110	27	2.0	83	72.0	94.0	2.0	69.5	127	5000	1.33
760311-2RZ TN1	55	120	29	2.0	90	77.0	101.0	2.0	78	146	4800	1.69
760312-2RZ TN1	60	130	31	2.1	98	82.5	117.5	2.1	88	166	4500	2.12
760313-2RZ TN1	65	140	33	2.1	105	91.5	118.5	2.1	100	196	4000	2.60
760314-2RZ TN1	70	150	35	2.1	113	95.5	124.5	2.1	110	220	3800	3.16
760315-2RZ TN1	75	160	37	2.1	120	105.5	135.5	2.1	125	255	3600	3.79
760316-2RZ TN1	80	170	39	2.1	128	111.0	143.0	2.1	137	285	3400	4.50
760317-2RZ TN1	85	180	41	3.0	135	116.0	151.0	3.0	160	325	3200	5.29
760318-2RZ TN1	90	190	43	3.0	143	122.5	157.5	3.0	163	345	3000	6.17
760319-2RZ TN1	95	200	45	3.0	150	130.0	165.0	3.0	163	360	3000	7.15
760320-2RZ TN1	100	215	47	3.0	160	140.0	178.0	3.0	193	430	2600	8.73
760322-2RZ TN1	110	240	50	3.0	176	154.5	200.0	3.0	250	560	2400	11.8
760324-2RZ TN1	120	260	55	3.0	192	165.0	210.0	3.0	265	620	2200	14.6
760326-2RZ TN1	130	280	58	3.0	206	181.0	229.0	3.0	290	695	2000	18.7

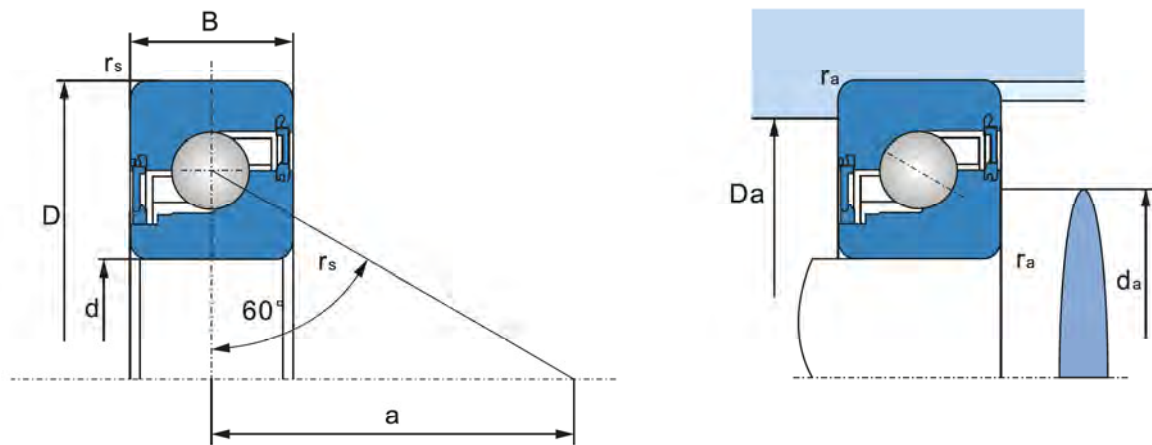

Non-standard metric series(sealed structure)

Bearing designations ZYS	Boundary dimensions					Reference mounting dimensions			Load rating		Limiting speed	Weight
						d _a	D _a	r _a				
	d	D	B	r _{smin}	a	h12	H12	max	C _a	C _{0a}	Grease r/min	kg ≈
mm					≈			KN				
BS1547-2RZ TN1	15	47	15	1.0	35	27.5	39.5	1.0	21.5	27	12000	0.14
BS1747-2RZ TN1	17	47	15	1.0	35	27.5	39.5	1.0	21.5	27	12000	0.14
BS2047-2RZ TN1	20	47	15	1.0	37	27.5	39.5	1.0	19.3	25	12000	0.13
BS2562-2RZ TN1	25	62	15	1.0	46	38.0	52.0	1.0	28.5	41.5	9000	0.24
BS3062-2RZ TN1	30	62	15	1.0	48	39.5	52.5	1.0	26	39	9000	0.23
BS3072-2RZ TN1	30	72	15	1.0	52	45.0	61.0	1.1	31	54	8000	0.35
BS3572-2RZ TN1	35	72	15	1.0	54	46.5	60.5	1.1	30	50	8000	0.30
BS4072-2RZ TN1	40	72	15	1.0	56	49.0	62.5	1.1	28	49	8000	0.26
BS4090-2RZ TN1	40	90	20	1.5	67	56.5	75.5	1.5	50	83	6300	0.65
BS4575-2RZ TN1	45	75	15	1.0	60	52.0	68.0	1.0	28.5	52	7500	0.26
BS45100-2RZ TN1	45	100	20	1.5	74	64.5	85.5	1.5	58.5	104	5600	0.81
BS50100-2RZ TN1	50	100	20	1.5	76	64.5	85.5	1.5	58.5	104	5600	0.75
BS5590-2RZ TN1	55	90	15	1.0	70	65.0	80.0	1.0	32.5	65.5	6300	0.38
BS55100-2RZ TN1	55	100	20	1.5	77	69.5	85.5	1.5	40.5	81.5	6000	0.75
BS55120-2RZ TN1	55	120	20	1.5	86	77.0	97.5	2.0	60	116	5000	1.18
BS60120-2RZ TN1	60	120	20	1.5	88	79.5	100.5	1.5	61	120	4800	1.11
BS75110-2RZ TN1	75	110	15	1.5	88	85.0	99.5	1.5	35.5	83	5000	0.75
BS100150-2RZ TN1	100	150	22.5	2.0	120	114.5	135.0	2.0	69.5	173	3800	1.37

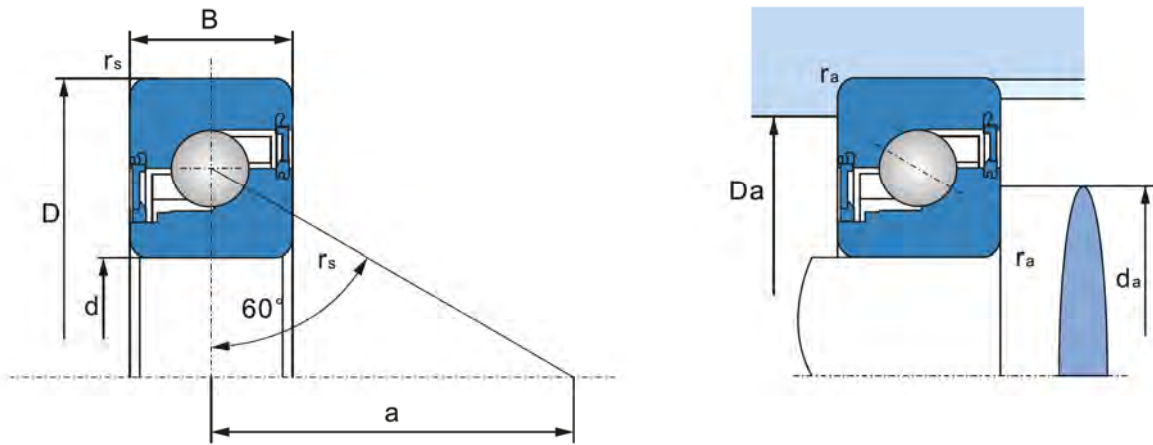

BSS inch series(sealed structure)

Bearing designations ZYS	Boundary dimensions					Reference mounting dimensions			Load rating		Limiting speed	Weight
						d _a	D _a	r _a				
	d	D	B	r _{smin}	a	h12	H12	max	C _a	C _{oa}	Grease r/min	kg ≈
mm ≈									KN			
BSS2047-2RZ TN1	20.000	47	15.875	1.0	38	27.5	39.5	1.0	19.3	25	12000	0.13
BSS2362-2RZ TN1	23.838	62	15.875	1.0	45	38.0	52.0	1.0	28.5	41.5	9000	0.24
BSS3872-2RZ TN1	38.100	72	15.875	1.0	56	49.0	62.5	1.1	28	49	8000	0.26
BSS4476-2RZ TN1	44.475	76.2	15.875	1.0	60	52.0	68.0	1.0	28.5	52	7500	0.26
BSS5790-2RZ TN1	57.150	90	15.875	1.0	72	65.0	80.0	1.0	32.5	65.5	6300	0.38
BSS76110-2RZ TN1	76.200	110	15.875	1.5	88	85.0	99.5	1.5	35.5	83	5000	0.75
BSS101145-2RZ TN1	101.600	145	22.225	1.5	118	114.5	132.0	2.0	69.5	173	3800	1.37

Ball screw support bearings unit

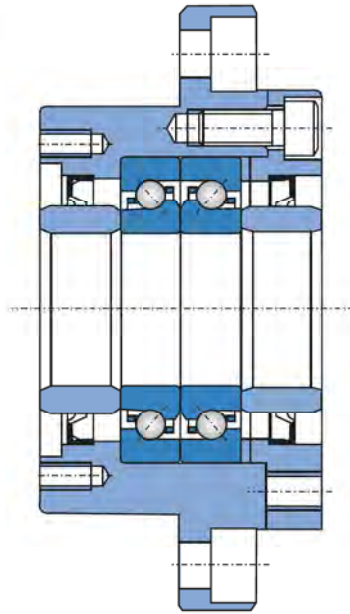

BSDU.....DF

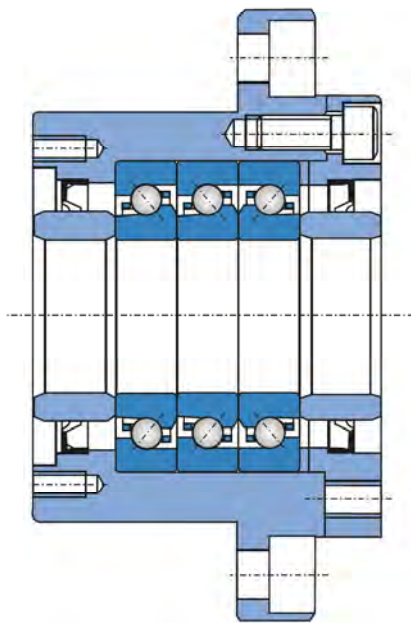

BSTU.....TFT

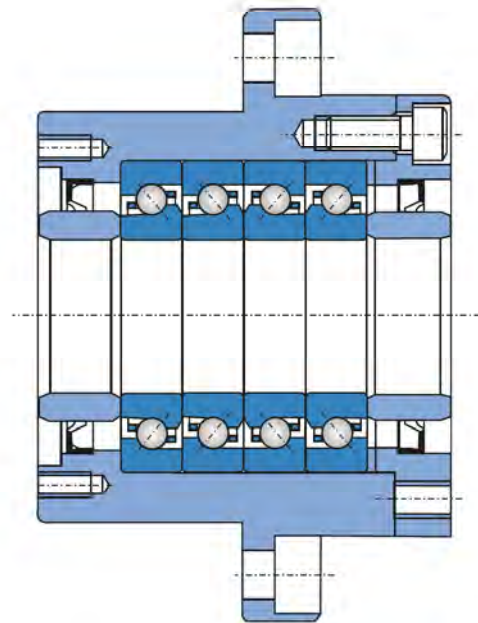

BSQU.....QFC

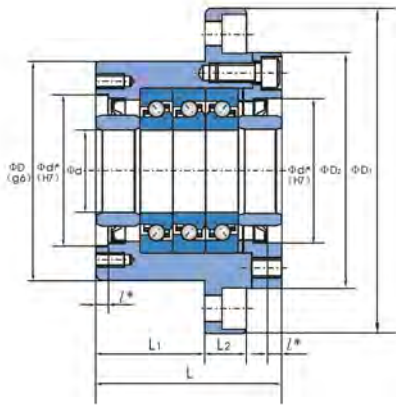

TFT (3 bearings arranged face-to-face and tramend)

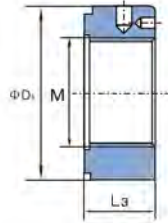

Locknut

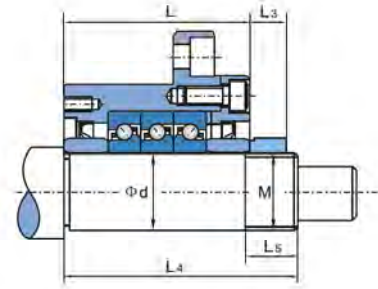

Dimension of components mounting part

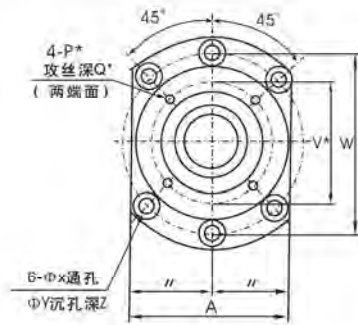

Bearing bore diameter $d \leq 30$

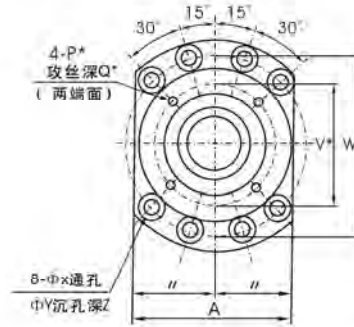

Bearing bore diameter $d \geq 35$

mm

Designations	Supporting components (mm)															Basic dynamic load rating Ca(N)	Limited axial (N)	Preload (N)	Axial rigidity (N/μm)	Starting torque (N.m)	Locknuts			Component mounting					
	d	D	D1	D2	L	L1	L2	A	W	X	Y	Z	d1	L'	V						P	Q	M	D3	L3	d	M	L4	L5
BSDU17DF	17	70	106	72	60	32	15	80	88	9	14	8.5	45	3	58	M5	10	21900	26600	2150	750	14	M17 ×1.0	37	18	17	M17 ×1.0	81	23
BSDU20DF	20	70	106	72	60	32	15	80	88	9	14	8.5	45	3	58	M5	10	21900	26600	2150	750	14	M20 ×1.0	40	18	20	M20 ×1.0	81	23
BSDU25DF	25	85	130	90	66	33	18	100	110	11	17.5	11	57	4	70	M6	12	28500	40500	3150	1000	23	M25 ×1.5	45	20	25	M25 ×1.5	89	26
BSTU25TFT	25	85	130	90	81	48	18	100	110	11	17.5	11	57	4	70	M6	12	46500	81500	4300	1470	31	M25 ×1.5	45	20	25	M25 ×1.5	104	26
BSDU30DF	30	85	130	90	66	33	18	100	110	11	17.5	11	57	4	70	M6	12	29200	43000	3350	1030	24	M30 ×1.5	50	20	30	M30 ×1.5	89	26
BSTU30TFT	30	85	130	90	81	48	18	100	110	11	17.5	11	57	4	70	M6	12	47500	86000	4500	1520	33	M30 ×1.5	50	20	30	M30 ×1.5	104	26
BSDU35DF	35	95	142	102	66	33	18	106	121	11	17.5	11	69	4	80	M6	12	31000	50000	3800	1180	28	M30 ×1.5	55	22	35	M30 ×1.5	92	30
BSTU35TFT	35	95	142	102	81	48	18	106	121	11	17.5	11	69	4	80	M6	12	50500	10000	5200	1710	37	M35 ×1.5	55	22	35	M35 ×1.5	107	30
BSQU35QFC	35	95	142	102	96	48	18	106	121	11	17.5	11	69	4	80	M6	12	50500	10000	7650	2350	55	M35 ×1.5	55	22	35	M35 ×1.5	122	30
BSDU40DF	40	95	142	102	66	33	18	106	121	11	17.5	11	69	4	80	M6	12	31500	52000	3900	1230	28	M40 ×1.5	60	20	40	M40 ×1.5	92	30
BSTU40TFT	40	95	142	102	81	48	18	106	121	11	17.5	11	69	4	80	M6	12	51500	104000	5300	1810	38	M40 ×1.5	60	20	40	M40 ×1.5	107	30
BSQU40QFC	40	95	142	102	96	48	18	106	121	11	17.5	11	69	4	80	M6	12	51500	104000	7850	2400	57	M40 ×1.5	60	20	40	M40 ×1.5	122	30

Precision locknuts

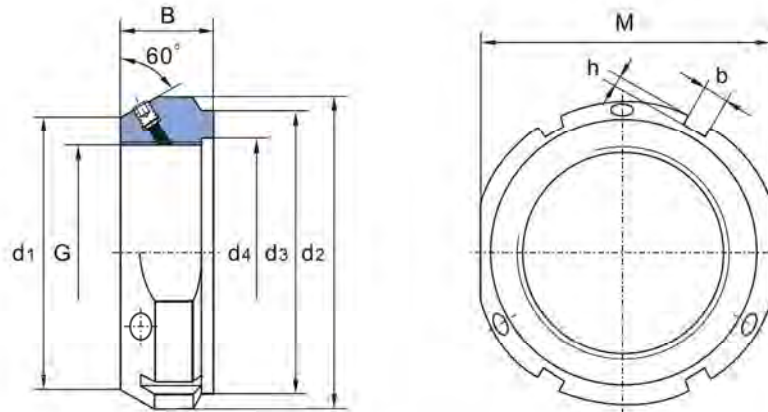

KMA-type locknuts

Locknut designations	Boundary dimensions (mm)									Axial static load(KN)	Flat head screw		Weight (kg)
	G	d ₁	d ₂	d ₃	d ₄	B	b	h	M		Dimensions (mm)	Tightening torques max(N.m)	
KMA0	M10×0.75	21	28	23	11	14	4	2	24	35	M5	4.5	0.045
KMA1	M12×1	23	30	25	13	14	4	2	27	40	M5	4.5	0.050
KMA2	M15×1	26	33	28	16	16	4	2	30	60	M5	4.5	0.075
KMA3	M17×1	29	37	33	18	18	5	2	34	80	M6	8	0.10
KMA4	M20×1	32	40	35	21	18	5	2	36	90	M6	8	0.11
KMA5	M25×1.5	36	44	39	26	20	5	2	41	130	M6	8	0.13
KMA6	M30×1.5	41	49	44	32	20	5	2	46	160	M6	8	0.16
KMA7	M35×1.5	46	54	49	38	22	5	2	50	190	M6	8	0.19
KMA8	M40×1.5	56	65	59	42	22	6	2.5	60	210	M6	8	0.30
KMA9	M45×1.5	61	70	64	48	22	6	2.5	65	240	M6	8	0.33
KMA10	M50×1.5	65	75	68	52	25	7	3	70	300	M6	8	0.40
KMA11	M55×2	74	85	78	58	25	7	3	80	340	M8	18	0.54
KMA12	M60×2	78	90	82	62	26	8	3.5	85	380	M8	18	0.61
KMA13	M65×2	83	95	87	68	28	8	3.5	90	460	M8	18	0.71
KMA14	M70×2	88	100	92	72	28	8	3.5	95	490	M8	18	0.75
KMA15	M75×2	93	105	97	77	28	8	3.5	100	520	M8	18	0.80
KMA16	M80×2	98	110	100	83	32	8	3.5	—	620	M8	18	0.90
KMA17	M85×2	107	120	110	88	32	10	4	—	650	M10	35	1.15
KMA18	M90×2	112	125	115	93	32	10	4	—	680	M10	35	1.20
KMA19	M95×2	117	130	120	98	32	10	4	—	710	M10	35	1.25
KMA20	M100×2	122	135	125	103	32	10	4	—	740	M10	35	1.30
KMA22	M110×2	132	145	134	112	32	10	4	—	800	M10	35	1.45
KMA24	M120×2	142	155	144	122	32	10	4	—	860	M10	35	1.60
KMA26	M130×2	152	165	154	132	32	12	5	—	920	M10	35	1.70
KMA28	M140×2	162	175	164	142	32	14	6	—	980	M10	35	1.80
KMA30	M150×2	172	185	174	152	32	14	6	—	1040	M10	35	1.95

Precision locknuts

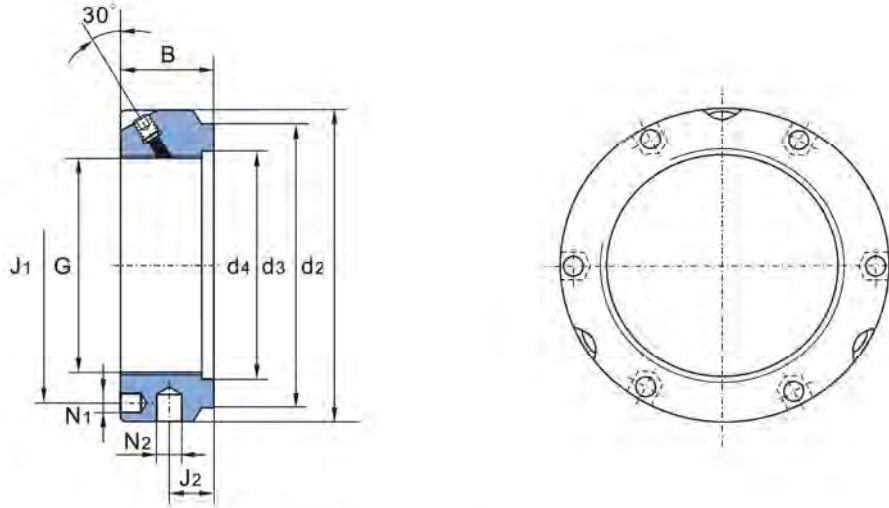

KMB-type locknuts

Locknut designations	Boundary dimensions (mm)									Axial static load (KN)	Flat head screw		Weight (kg)
	G	d ₂ h11	d ₃	d ₄	B	J ₁	J ₂	N ₁	N ₂		Dimensions (mm)	Tightening torques max(N.m)	
KMB5	M25×1.5	42	35	26	20	32.5	11	4.3	4	130	M6	8	0.13
KMB6	M30×1.5	48	40	32	20	40.5	11	4.3	5	160	M6	8	0.16
KMB7	M35×1.5	53	47	38	20	45.5	11	4.3	5	190	M6	8	0.19
KMB8	M40×1.5	58	52	42	22	50.5	12	4.3	5	210	M6	8	0.23
KMB9	M45×1.5	68	58	48	22	58	12	4.3	6	240	M6	8	0.33
KMB10	M50×1.5	70	63	52	24	61.5	13	4.3	6	300	M6	8	0.34
KMB11	M55×1.5	75	70	58	24	66.5	13	4.3	6	340	M6	8	0.37
KMB12	M60×1.5	84	75	62	24	74.5	13	5.3	6	380	M6	8	0.49
KMB13	M65×1.5	88	80	68	25	78.5	13	5.3	6	460	M6	8	0.52
KMB14	M70×1.5	95	86	72	26	85	14	5.3	8	490	M8	18	0.62
KMB15	M75×1.5	100	91	77	26	88	13	6.4	8	520	M8	18	0.66
KMB16	M80×2	110	97	83	30	95	16	6.4	8	620	M8	18	1.00
KMB17	M85×2	115	102	88	32	100	17	6.4	8	650	M10	35	1.15
KMB18	M90×2	120	110	93	32	108	17	6.4	8	680	M10	35	1.20
KMB19	M95×2	125	114	98	32	113	17	6.4	8	710	M10	35	1.25
KMB20	M100×2	130	120	103	32	118	17	6.4	8	740	M10	35	1.30
KMB22	M110×2	140	132	112	32	128	17	6.4	8	800	M10	35	1.45
KMB24	M120×2	155	142	122	32	140	17	6.4	8	860	M10	35	1.85
KMB26	M130×3	165	156	132	32	153	17	6.4	8	920	M10	35	2.00
KMB28	M140×3	180	166	142	32	165	17	6.4	10	980	M10	35	2.45
KMB30	M150×3	190	180	152	32	175	17	6.4	10	1040	M10	35	2.60

Rotary table bearings

Bearing designations	Bore diameter d (mm)			Outer diameter D(mm)			Mounting dimensions H (mm)		Axial and radial runout (µm)
	Nominal dimension	Upper deviation	Lower deviation	Nominal dimension	Upper deviation	Lower deviation	Nominal dimension	Deviation	
YRT50	50	0	-0.008	126	0	-0.011	20	±0.125	2
YRT80	80	0	-0.009	146	0	-0.011	23.35	±0.15	3
YRT100	100	0	-0.01	185	0	-0.015	25	±0.175	3
YRT120	120	0	-0.01	210	0	-0.015	26	±0.175	3
YRT150	150	0	-0.013	240	0	-0.015	26	±0.175	3
YRT180	180	0	-0.013	280	0	-0.018	29	±0.175	4
YRT200	200	0	-0.015	300	0	-0.018	30	±0.175	4
YRT260	260	0	-0.018	385	0	-0.02	36.5	±0.2	6
YRT325	325	0	-0.023	450	0	-0.023	40	±0.2	6
YRT395	395	0	-0.023	525	0	-0.028	42.5	±0.2	6
YRT460	460	0	-0.023	600	0	-0.028	46	±0.225	6
YRT580	580	0	-0.025	750	0	-0.035	60	±0.25	10
YRT650	650	0	-0.038	870	0	-0.05	78	±0.25	10
YRT850	850	0	-0.05	1095	0	-0.063	80.5	±0.3	12
YRT950	950	0	-0.05	1200	0	-0.063	86	±0.3	12
YRT1030	1030	0	-0.063	1300	0	-0.08	92.5	±0.3	12

The accuracy of shaft and housing which fit rotary table bearings should accord with the corresponding requirements.

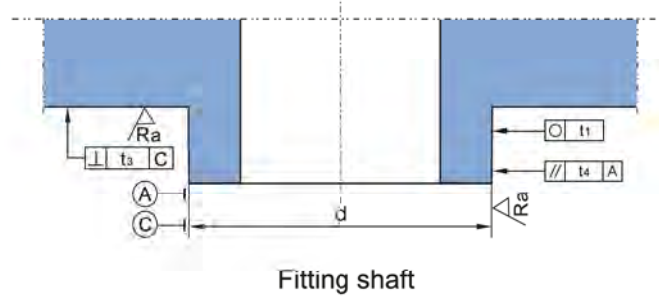

Tolerances of fitting shaft for rotary table bearings

Bearing designations	Journal (mm)			Roundness t_1 (μm)	Perpendicularity t_3 (μm)	Parallelism t_4 (μm)	Surface roughness R_a (μm)
	Nominal dimension	Upper deviation	Lower deviation				
YRT50	50	0	-0.011	3	3	3	0.8
YRT80	80	0	-0.013	3	3	3	0.8
YRT100	100	0	-0.013	4	4	4	0.8
YRT120	120	0	-0.015	4	4	4	0.8
YRT150	150	0	-0.018	5	5	5	0.8
YRT180	180	0	-0.018	5	5	5	0.8
YRT200	200	0	-0.02	7	7	7	0.8
YRT260	260	0	-0.023	8	8	8	0.8
YRT325	325	0	-0.025	9	9	9	0.8
YRT395	395	0	-0.025	9	9	9	0.8
YRT460	460	0	-0.027	10	10	10	0.8
YRT580	580	0	-0.032	11	11	11	0.8
YRT650	650	0	-0.036	13	13	13	0.8
YRT850	850	0	-0.040	15	15	15	0.8
YRT950	950	0	-0.040	15	15	15	0.8
YRT1030	1030	0	-0.047	18	18	18	0.8

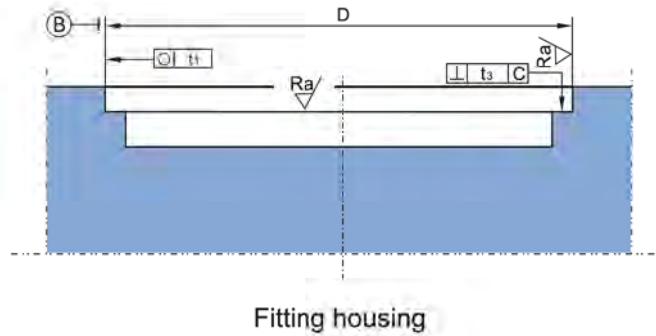

Tolerances of fitting housing for rotary table bearings

Bearing designations	Housing (mm)			Roundness t_1 (μm)	Perpendicularity t_3 (μm)	Surface roughness R_a (μm)
	Nominal dimension	Upper deviation	Lower deviation			
YRT50	126	+0.018	-0.007	5	5	0.8
YRT80	146	+0.018	-0.007	5	5	0.8
YRT100	185	+0.022	-0.007	7	7	0.8
YRT120	210	+0.022	-0.007	7	7	0.8
YRT150	240	+0.022	-0.007	7	7	0.8
YRT180	280	+0.025	-0.007	8	8	0.8
YRT200	300	+0.025	-0.007	8	8	0.8
YRT260	385	+0.029	-0.007	9	9	0.8
YRT325	450	+0.033	-0.007	10	10	0.8
YRT395	525	+0.034	-0.007	11	11	0.8
YRT460	600	+0.034	-0.007	11	11	0.8
YRT580	750	+0.038	-0.008	13	13	0.8
YRT650	870	+0.044	-0.012	15	15	0.8
YRT850	1095	+0.052	-0.014	18	18	0.8
YRT950	1200	+0.052	-0.014	18	18	0.8
YRT1030	1300	+0.062	-0.016	20	20	0.8

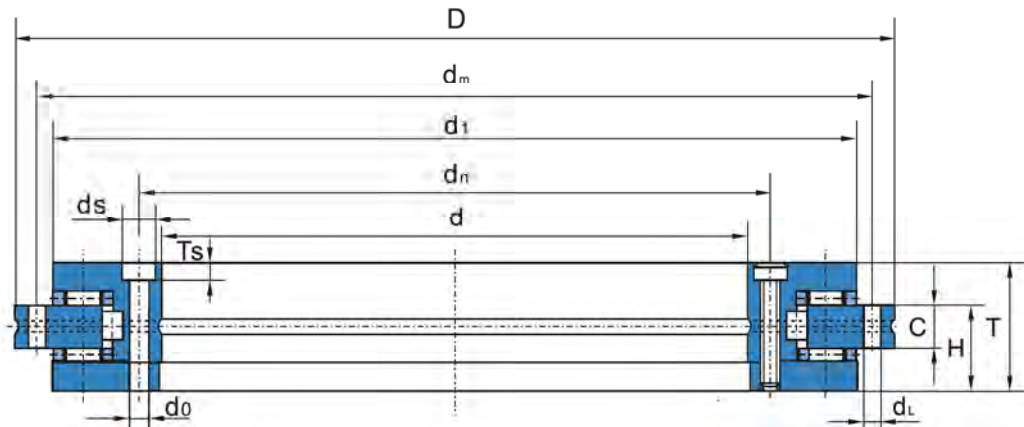

Bearing designations	Boundary dimensions								Mounting holes					
									Inner ring			Outer ring		
	d	D	T	H	C	d ₁	d _n	d _m	d _o	d _s	T _s	Quantity	d _L mm	Quantity
mm								mm						
YRT50	50	126	30	20	10	105	63	116	5.6	-	-	10	5.6	12
YRT80	80	146	35	23.35	12	130	92	138	5.6	10	4	10	4.6	12
YRT100	100	185	38	25	12	160	112	170	5.6	10	5.4	16	5.6	15
YRT120	120	210	40	26	12	184	135	195	7	11	6.2	22	7	21
YRT150	150	240	40	26	12	214	165	225	7	11	6.2	34	7	33
YRT180	180	280	43	29	15	244	194	260	7	11	6.2	46	7	45
YRT200	200	300	45	30	15	274	215	285	7	11	6.2	46	7	45
YRT260	260	385	55	36.5	18	345	280	365	9.3	15	8.2	34	9.3	33
YRT325	325	450	60	40	20	415	342	430	9.3	15	8.2	34	9.3	33
YRT395	395	525	65	42.5	20	486	415	505	9.3	15	8.2	46	9.3	45
YRT460	460	600	70	46	22	560	482	580	9.3	15	8.2	46	9.3	45
YRT580	580	750	90	60	30	700	610	720	11.4	18	11	46	11.4	42
YRT650	650	870	122	78	34	800	680	830	14	20	13	46	14	42
YRT850	850	1095	124	80.5	37	1018	890	1055	18	26	17	58	18	54
YRT950	950	1200	132	86	40	1130	990	1160	18	26	17	58	18	54
YRT1030	1030	1300	145	92.5	40	1215	1075	1255	18	26	17	60	18	66

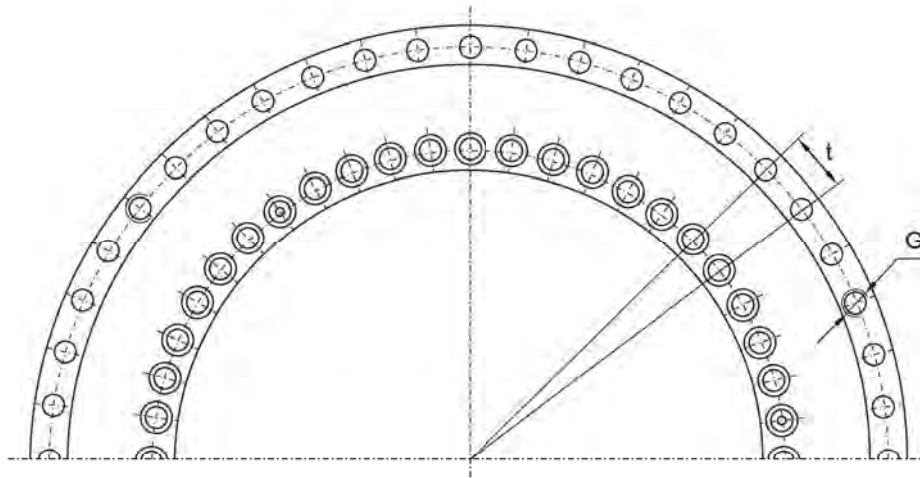

Quantity of fastening screw	Threaded extraction hole		Pitch ¹⁾	Screw tightening torque M _A ²⁾	Basic rated load				Limited speed	Bearing Frictional torque ³⁾	Mass	Bearing designations
					Axial		Radial					
	G	Quantity	Quantity × t	Nm	Dynamic	Static	Dynamic	Static	Grease	Nm	Kg	
					C _a	C _{oa}	C _r	C _{or}				
					KN							
2	-	-	12×30°	8.5	38	158	28.5	49.5	440	2.5	1.6	YRT50
2	-	-	12×30°	8.5	56	280	44	98	350	3	2.4	YRT80
2	M5	3	18×20°	8.5	73	370	52	108	280	3	4.1	YRT100
2	M8	3	24×15°	14	80	445	70	148	230	7	5.3	YRT120
2	M8	3	36×10°	14	85	510	77	179	210	10	6.2	YRT150
2	M8	3	48×7.5°	14	92	580	83	209	190	12	7.7	YRT180
2	M8	3	48×7.5°	14	98	650	89	236	170	14	9.7	YRT200
2	M12	3	36×10°	34	109	810	102	310	130	20	18.3	YRT260
2	M12	3	36×10°	34	186	1710	134	415	110	40	25	YRT325
2	M12	3	48×7.5°	34	202	2010	133	435	90	55	33	YRT395
2	M12	3	48×7.5°	34	217	2300	187	650	80	70	45	YRT460
2	M12	6	48×7.5°	68	390	3600	211	820	60	140	89	YRT580
2	M12	6	48×7.5°	116	495	5200	415	1500	55	200	170	YRT650
2	M16	6	60×6°	284	560	6600	475	1970	40	300	253	YRT850
2	M16	6	60×6°	284	1040	10300	600	2450	40	600	312	YRT950
12	M16	6	72×5°	284	1080	11000	620	2650	35	800	375	YRT1030

Notes:

- 1) Include fastening screw and threaded extraction hole.
- 2) Refers to fixing screw.
- 3) Bearing friction torque should be measured at the speed of 5 r/min, starting friction torque should be 2 to 2.5 times of the values in above table.

13 Comparison table of bearing designations between ZYS and other manufacturers

Bearing types	ZYS	SNFA	FAG	SKF	NSK	GMN	FAFNIR	RHP	
Angular contact ball bearings	718	SEA	B718						
	719	SEB	B719	719	79	S619	93WI	79	
	70	EX	B70	70	70	S60	91WI	70	
	72	E200	B72	72	72	S62	2WI	72	
	H719	HB...VEB				BNC19		993WN	S79
	H70	HX-VEX		70CC	BNC10	SH60		991WN	S70
	HS719		HS719						
	HS70		HS70						
	B719-2RZ	HB.../S	HSS719						
	B70-2RZ	HX.../S VEX.../S	HSS70						
B70						SN60	91WO		
Cylindrical roller bearings	N10 K		N10 K	N10AK	N10 KR				
	NN30K		NN30K	NN30K	NN30 KR				
Double- direction angular contact thrust ball bearings	2344		2344	2344	TAC 20X				
	2347		2347	2347					
High-speed angular contact thrust ball bearings	70A/DB				BA 10X				
	70B/DB				BA 10X				
Tapered roller bearings	320		320X	320X					
Ball screw support bearings	7602	BS200	7602	BSA2	TAC02				
	7603		7603	BSA3	TAC03				
	BS		BSB	BSD	TAC				
	BSS			BDAB	TAC				

Note: This table only refers to the structural comparison without links to relevant technical features.



Fröhlich & Dörken GmbH

Stefansbecke 44 | 45549 Sprockhövel
Tel.: 02339/123-45 | Fax: 02339/123-23

www.fud.de